

APPROVAL SHEET

WLFW2520 **Wire Wound Ferrite Chip Inductors**

*Contents in this sheet are subject to change without prior notice.

FEATURES

1. General Purpose Inductor for any electronic device.
2. Wire Wound structure with Lower DCR High Q
3. Standard Chip size

APPLICATIONS

1. General Purposes in Analog signal process
2. LC Filter, EMI rejection and Noise rejection notch.

SHAPE and DIMENSION

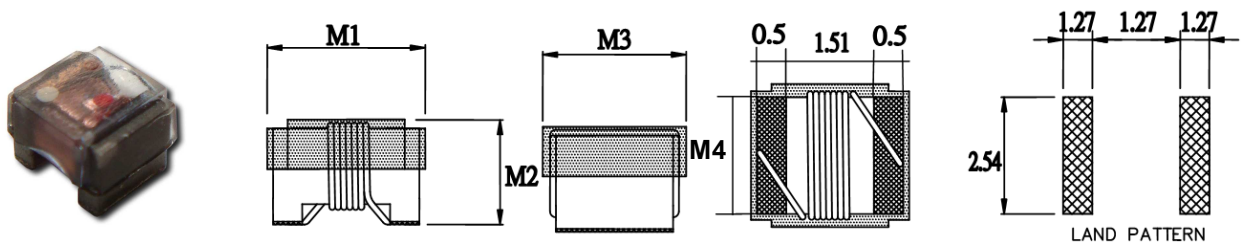

Unit: mm

Series	M1	M2	M3	M4
WLFW2520	2.72±0.2	1.83±0.2	2.59±0.2	2.03±0.05

MARKING

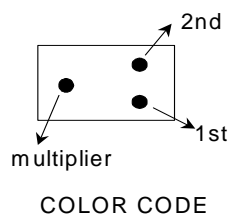

Example : WLFW2520Z0□2R7PB

MARKING : Dots 1 and 2 indicate the inductance in nano Henries.
(DOTS 1 : RED · DOTS 2 : VIOLET)
Dots 3 indicate number of zeroes to be added.
(DOTS 3 : RED)

MARK COLOR CODE , Please refer to “Electrical Characteristics”

ORDERING INFORMATION

WL	FW	2520	Z0	J	47N	P	B
Product Code WL: Inductor	Series Wire Wound Ferrite Chip inductor.	Dimensions 2.5 * 2.0 mm 2520 :EIA 1008	Series extension STD	Tolerance H: ± 3% J: ± 5% K: ± 10%	Value 47N =47nH =0.047uH R10=0.1uH 1R0=1.0uH 100 = 10uH	Packing Code P= 7" Plastic Tape	B:STD

Electrical Characteristics

● WLFW2520 series

Part No	L (μ H)	Test Freq. (MHz)	Inductance Tolerance	Q Min	Test Freq. (MHz)	SRF (MHz) Min	DCR (OHM) Max	I _{rms} (mA)	COLOR CODE		
									1st	2nd	multiplier
WLFW2520Z0□47NPB	0.047	50	J、K	50	50	1800	0.045	650	Yellow	Violet	Black
WLFW2520Z0□68NPB	0.068	50	J、K	50	50	1800	0.045	650	Blue	Gray	Black
WLFW2520Z0□82NPB	0.082	50	J、K	50	50	1800	0.035	1000	Gray	Red	Black
WLFW2520Z0□R10PB	0.10	50	H、J、K	50	50	1800	0.196	700	Brown	Black	Brown
WLFW2520Z0□R18PB	0.18	50	J、K	50	50	1000	0.290	700	Brown	Gray	Brown
WLFW2520Z0□R20PB	0.20	50	J、K	50	50	900	0.285	700	Red	Black	Brown
WLFW2520Z0□R24PB	0.24	50	J、K	50	50	900	0.135	700	Red	Yellow	Brown
WLFW2520Z0□R56PB	0.56	7.9	J、K	40	50	460	0.300	700	Green	Blue	Brown
WLFW2520Z0□R68PB	0.68	7.9	J、K	27	50	400	0.320	700	Blue	Gray	Brown
WLFW2520Z0□1R0PB	1.0	50	J、K	50	50	380	0.620	650	Brown	Black	Red
WLFW2520Z0□1R2PB	1.2	7.9	J、K	48	50	210	0.68	650	Brown	Red	Red
WLFW2520Z0□1R5PB	1.5	7.9	J、K	41	50	190	0.76	630	Brown	Green	Red
WLFW2520Z0□1R8PB	1.8	7.9	J、K	39	50	170	0.84	600	Brown	Gray	Red
WLFW2520Z0□2R2PB	2.2	7.9	J、K	34	50	150	1.10	520	Red	Red	Red
WLFW2520Z0□2R7PB	2.7	7.9	J、K	34	50	135	1.28	490	Red	Violet	Red
WLFW2520Z0□3R3PB	3.3	7.9	J、K	32	50	120	1.46	450	Orange	Orange	Red
WLFW2520Z0□3R9PB	3.9	7.9	J、K	32	7.9	105	1.56	420	Orange	White	Red
WLFW2520Z0□4R3PB	4.3	7.9	J、K	30	7.9	85	1.70	400	Yellow	Orange	Red
WLFW2520Z0□4R7PB	4.7	7.9	J、K	31	7.9	90	1.68	400	Yellow	Violet	Red
WLFW2520Z0□5R6PB	5.6	7.9	J、K	31	7.9	80	1.82	380	Green	Blue	Red
WLFW2520Z0□6R8PB	6.8	7.9	J、K	31	7.9	70	2.00	360	Blue	Gray	Red
WLFW2520Z0□8R2PB	8.2	7.9	J、K	23	7.9	65	2.65	330	Gray	Red	Red
WLFW2520Z0□100PB	10.0	7.9	J、K	31	7.9	60	2.95	300	Brown	Black	Orange
WLFW2520Z0□120PB	12.0	7.9	J、K	30	7.9	50	3.35	270	Brown	Red	Orange
WLFW2520Z0□150PB	15.0	7.9	J、K	38	7.9	50	3.04	250	Brown	Green	Orange
WLFW2520Z0□220PB	22.0	2.52	J、K	10	2.52	10	2.80	120	Red	Red	Orange

Tolerance : :K \pm 10%、J \pm 5%、H \pm 3%

※MSL : LEVEL1

RATING TEMPERATURE

OPERATING TEMPERATURE RANGE : -40°C ~ +125°C

TEST INSTRUMENT

L、Q TEST BY HP4291B

SRF TEST BY HP 8753E

DCR TEST BY ZENTECH 502BC

RELIABILITY PERFORMANCE**Reliability Experiment For Electrical**

Test Item	Test Condition	Standard Source
Humidity Test	+40°C ± 2°C, humidity of 90% ± 5% (total 96 hours).	MIL-STD-202G Method 103B Test Condition B
High Temperature Test	1. Temperature: +125°C ± 2°C 2. Test time: 48 ± 2hrs	IEC 68-2 Test Condition B
Low Temperature Test	1. Temperature: -40°C ± 2°C 2. Test time: 48 ± 2hrs	IEC 68-2 Test Condition A
Thermal Shock	+125°C ± 5°C (30 minutes) ~ -40 ± 5°C (30 minutes), temperature switch time: 5 minutes (total 50 cycles).	MIL-STD-202G Method 107G Test Condition B-2
Life Test	+70°C ± 5°C (250Hours)	MIL-STD-202G Method 108A Test Condition B

Reliability Experiment For Physical

Test Item	Test Condition	Standard Source
Vibration Test	10-55-10HZ, amplitude: 1.5mm, direction: X, Y, Z axes, each axis 2 hours (total 6 hours).	MIL-STD-202G Method 201A
Solder Heat Resistance Test	IR/convection reflow: Peak Temp 250 ± 5°C for 5Sec in air, Through 2 Cycle. Temperature Ramp: +1~4°C/sec; Above 183°C, must keep 90 s - 120 s	MIL-STD-202G Method 210F Test Condition (Reflow)
Solder Ability Test	Soak in 245 °C solder pot of 3Sec, PAD must have 95% above coverage.	J-STD-003B

TYPICAL RoHS REFLOW PROFILE

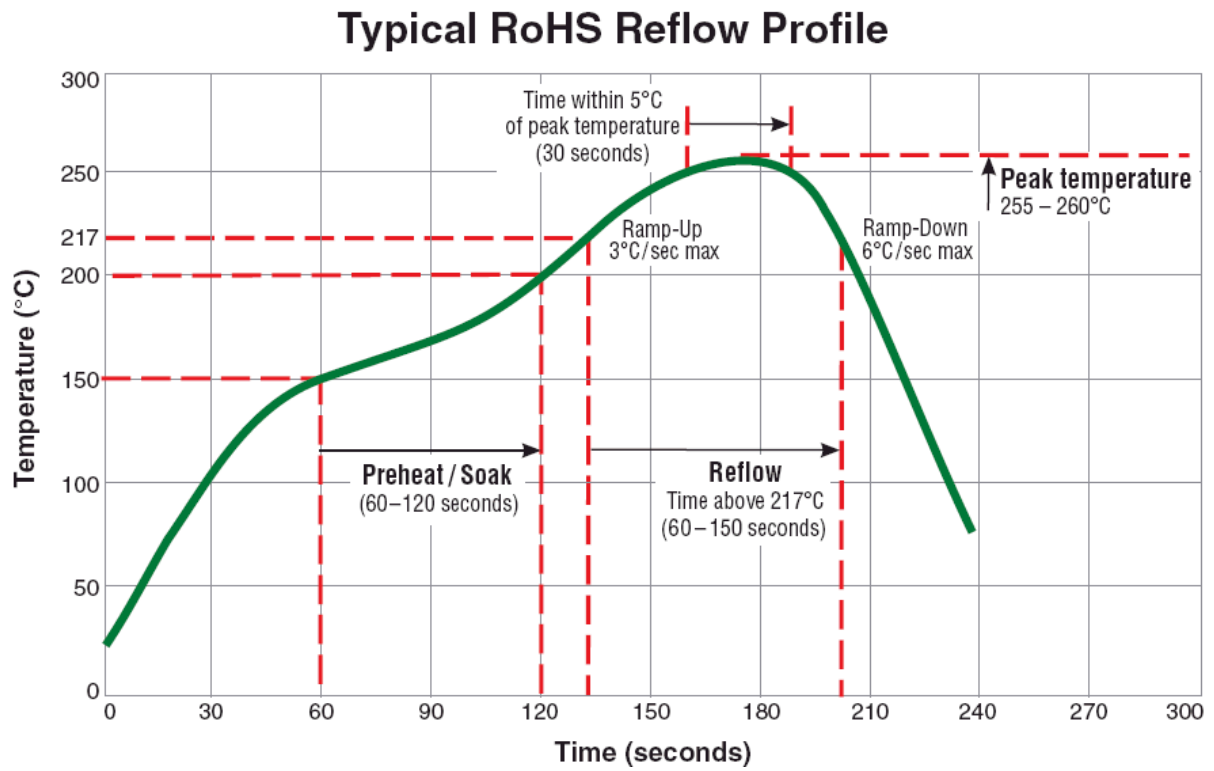

PACKAGING SPECIFICATION

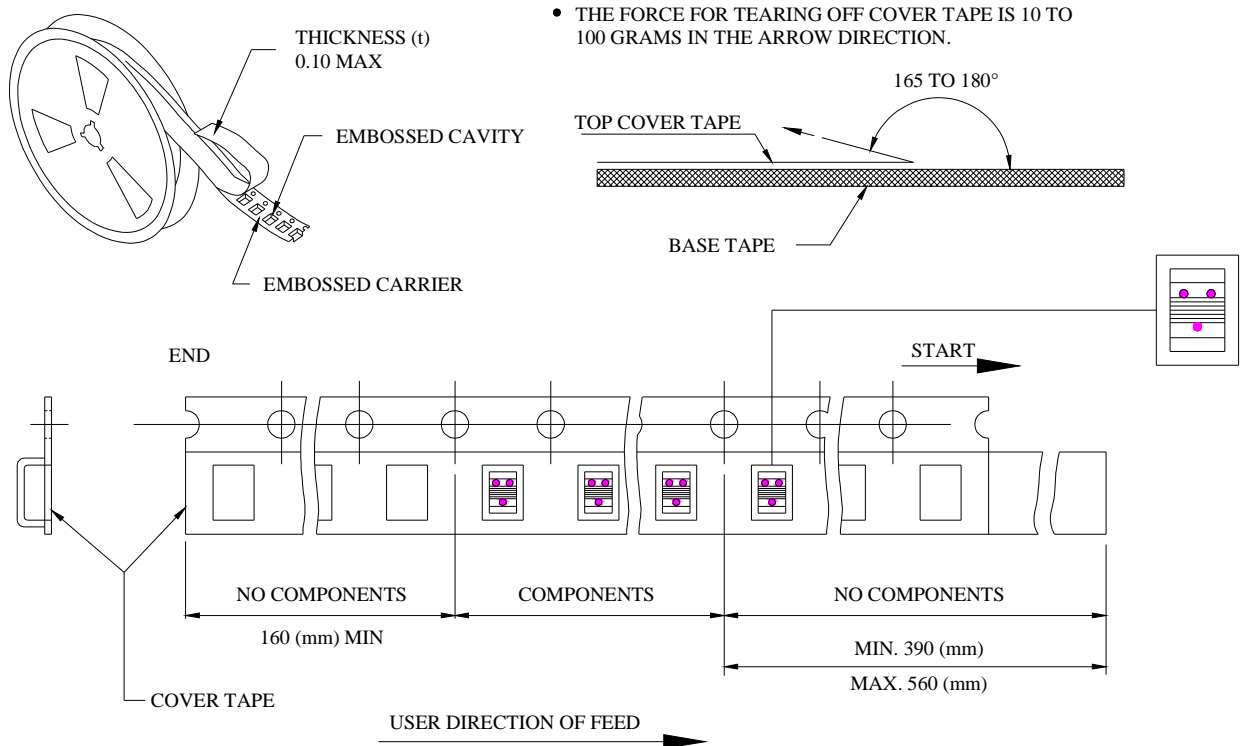

■ CARRIER TAPE REELS (mm)

MATERIAL: PLASTIC

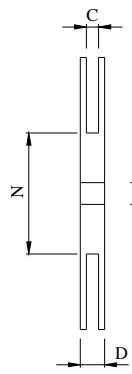
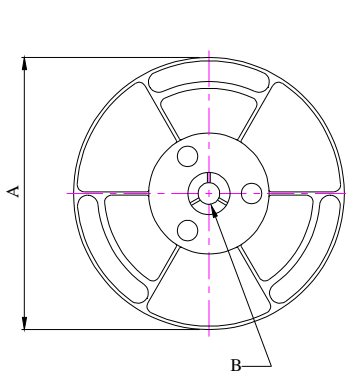

■ DIMENSIONS OF CARRIER TAPE (mm)

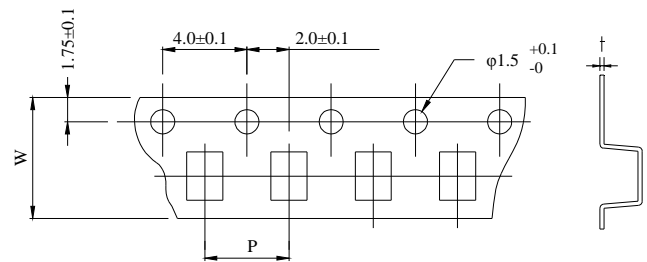

UNIT:mm

	A	B	C	D	N	P	W	t
DIM.	178	13.0	8.4	12.5	75	4.0	8.0	0.26
TOL.	±2.0	±0.8	+1.0-0	MAX	±1.5	±0.1	±0.2	±0.05

Quantity per reel : 2K pcs / reel