

# APPROVAL SHEET

## **WLF12012 Ferrite Chip Inductors**

\*Contents in this sheet are subject to change without prior notice.

## FEATURES

1. General purpose chip ferrite power inductor for high integration electronics device.
2. Ceramic structure provides high reliability 、 high productivity.
3. RoHS compliance.

## APPLICATIONS

1. EMI solution for I/O ports.
2. RF choke for DC power supplying to LNA or external antenna.

## SHAPE and DIMENSION

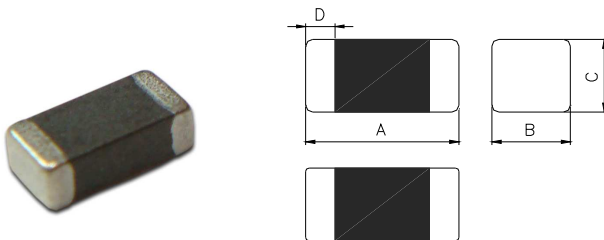

| Chip Size |                          |
|-----------|--------------------------|
| <b>A</b>  | 2.00±0.20                |
| <b>B</b>  | 1.25±0.20                |
| <b>C</b>  | 0.85±0.20      1.25±0.20 |
| <b>D</b>  | 0.50±0.30                |

Units: mm

## Ordering Information

| WL                  | FI                            | 2012                           | Z0                      | M                | R22  | T  | B     |
|---------------------|-------------------------------|--------------------------------|-------------------------|------------------|--|--|-------|
| <b>Product Code</b> | <b>Series</b>                 | <b>Dimensions</b>              | <b>Series extension</b> | <b>Tolerance</b> | <b>Value</b>                                 | <b>Packing Code</b>                            |       |
| WL:<br>Inductor     | FI : Ferrite<br>Chip Inductor | 2.0 * 1.2 mm<br>2012 :EIA 0805 | Z0 :STD                 | M: ±20%          | R22 = 0.22 uH<br>2R2 = 2.2 uH<br>100 = 10 uH | T = 7"<br>Paper Tape<br>P = 7"<br>Plastic Tape | B:STD |

## Electrical Characteristics

### ● WLF2012 series

| Walsin Part Number | Thickness<br>C size<br>(mm) | Inductance<br>( $\mu$ H) | Tolerance | Q  | Test Frequency<br>(MHz) | SRF<br>(MHz)<br>min. | DC<br>Resistance<br>( $\Omega$ ) max. | Rated<br>Current<br>(mA) max. |
|--------------------|-----------------------------|--------------------------|-----------|----|-------------------------|----------------------|---------------------------------------|-------------------------------|
| WLF2012Z0M47NTB    | 0.85 $\pm$ 0.20             | 0.047                    | M         | 15 | 60mV / 50M              | 320                  | 0.20                                  | 300                           |
| WLF2012Z0M68NTB    | 0.85 $\pm$ 0.20             | 0.068                    | M         | 15 | 60mV / 50M              | 280                  | 0.20                                  | 300                           |
| WLF2012Z0M82NTB    | 0.85 $\pm$ 0.20             | 0.082                    | M         | 15 | 60mV / 50M              | 255                  | 0.20                                  | 300                           |
| WLF2012Z0MR10TB    | 0.85 $\pm$ 0.20             | 0.10                     | M         | 20 | 60mV / 25M              | 235                  | 0.30                                  | 250                           |
| WLF2012Z0MR12TB    | 0.85 $\pm$ 0.20             | 0.12                     | M         | 20 | 60mV / 25M              | 220                  | 0.30                                  | 250                           |
| WLF2012Z0MR15TB    | 0.85 $\pm$ 0.20             | 0.15                     | M         | 20 | 60mV / 25M              | 200                  | 0.40                                  | 250                           |
| WLF2012Z0MR18TB    | 0.85 $\pm$ 0.20             | 0.18                     | M         | 20 | 60mV / 25M              | 185                  | 0.40                                  | 250                           |
| WLF2012Z0MR22TB    | 0.85 $\pm$ 0.20             | 0.22                     | M         | 20 | 60mV / 25M              | 170                  | 0.50                                  | 250                           |
| WLF2012Z0MR27TB    | 0.85 $\pm$ 0.20             | 0.27                     | M         | 20 | 60mV / 25M              | 150                  | 0.50                                  | 250                           |
| WLF2012Z0MR33TB    | 0.85 $\pm$ 0.20             | 0.33                     | M         | 20 | 60mV / 25M              | 145                  | 0.55                                  | 250                           |
| WLF2012Z0MR39TB    | 0.85 $\pm$ 0.20             | 0.39                     | M         | 25 | 60mV / 25M              | 135                  | 0.65                                  | 200                           |
| WLF2012Z0MR47PB    | 1.25 $\pm$ 0.20             | 0.47                     | M         | 25 | 60mV / 25M              | 125                  | 0.65                                  | 200                           |
| WLF2012Z0MR56PB    | 1.25 $\pm$ 0.20             | 0.56                     | M         | 25 | 60mV / 25M              | 115                  | 0.75                                  | 150                           |
| WLF2012Z0MR68PB    | 1.25 $\pm$ 0.20             | 0.68                     | M         | 25 | 60mV / 25M              | 105                  | 0.80                                  | 150                           |
| WLF2012Z0M1R0TB    | 0.85 $\pm$ 0.20             | 1.0                      | M         | 45 | 60mV / 10M              | 75                   | 0.40                                  | 50                            |
| WLF2012Z0M1R5TB    | 0.85 $\pm$ 0.20             | 1.5                      | M         | 45 | 60mV / 10M              | 60                   | 0.50                                  | 50                            |
| WLF2012Z0M1R8TB    | 0.85 $\pm$ 0.20             | 1.8                      | M         | 45 | 60mV / 10M              | 55                   | 0.60                                  | 50                            |
| WLF2012Z0M2R2TB    | 0.85 $\pm$ 0.20             | 2.2                      | M         | 45 | 60mV / 10M              | 50                   | 0.65                                  | 30                            |
| WLF2012Z0M2R7PB    | 1.25 $\pm$ 0.20             | 2.7                      | M         | 45 | 60mV / 10M              | 45                   | 0.75                                  | 30                            |
| WLF2012Z0M3R3PB    | 1.25 $\pm$ 0.20             | 3.3                      | M         | 45 | 60mV / 10M              | 41                   | 0.80                                  | 30                            |
| WLF2012Z0M4R7PB    | 1.25 $\pm$ 0.20             | 4.7                      | M         | 45 | 60mV / 10M              | 35                   | 1.00                                  | 30                            |
| WLF2012Z0M100PB    | 1.25 $\pm$ 0.20             | 10.0                     | M         | 45 | 60mV / 2M               | 24                   | 1.15                                  | 15                            |

NOTE :TOLERANCE M=  $\pm$ 20%

## Characteristic Curve

Q - Frequency

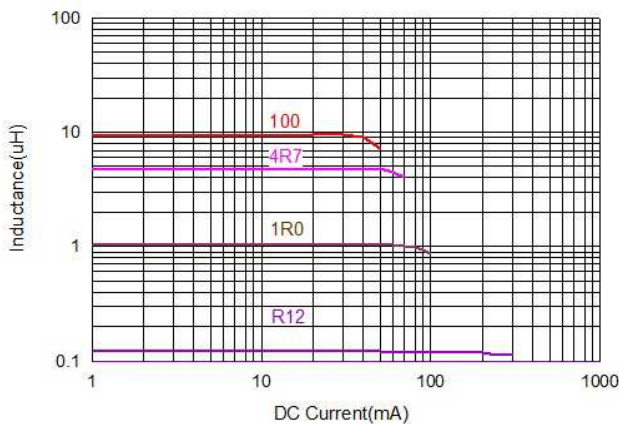

Inductance - Current

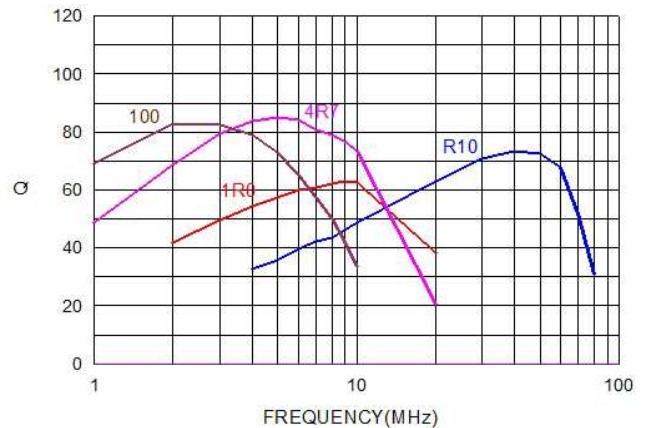

Test condition & Requirements

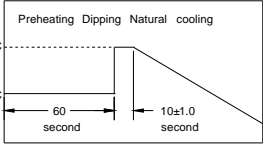
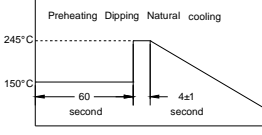
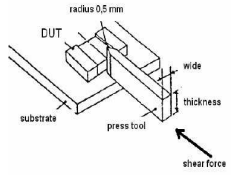
| Item                               | Performance  | Test Condition   |           |                           |                          |           |                           |     |       |     |           |      |      |     |   |           |      |
|------------------------------------|--|--|-----------|---------------------------|--------------------------|-----------|---------------------------|-----|-------|-----|-----------|------|------|-----|---|-----------|------|
| Operating Temperature              | -40~+105°C<br>(Including self-temperature rise)  | --   |           |                           |                          |           |                           |     |       |     |           |      |      |     |   |           |      |
| Transportation Storage Temperature | -40~+105°C<br>(on board)   | For long storage conditions, please see the Application Notice   |           |                           |                          |           |                           |     |       |     |           |      |      |     |   |           |      |
| Impedance (Z)                      | Refer to standard electrical characteristics list  | Agilent4291  |           |                           |                          |           |                           |     |       |     |           |      |      |     |   |           |      |
| Inductance (Ls)                    |  | Agilent E4991  |           |                           |                          |           |                           |     |       |     |           |      |      |     |   |           |      |
| Q Factor                           |  | Agilent4287  |           |                           |                          |           |                           |     |       |     |           |      |      |     |   |           |      |
| DC Resistance                      |  | Agilent16192   |           |                           |                          |           |                           |     |       |     |           |      |      |     |   |           |      |
| Rated Current                      |  | Agilent 4338   |           |                           |                          |           |                           |     |       |     |           |      |      |     |   |           |      |
| Temperature Rise Test              | Rated Current < 1A ΔT 20°C Max<br>Rated Current ≥ 1A ΔT 40°C Max   | 1. Applied the allowed DC current.<br>2. Temperature measured by digital surface thermometer.  |           |                           |                          |           |                           |     |       |     |           |      |      |     |   |           |      |
| Resistance to Soldering Heat       | Appearance : No damage.<br>Impedance : within±15% of initial value<br>Inductance : within±10% of initial value<br>Q : Shall not exceed the specification value.<br>RDC : within ±15% of initial value and shall not exceed the specification value   | Preheat: 150°C,60sec.<br>Solder: Sn99.5%-Cu0.5%<br>Solder temperature: 260±5°C<br>Flux for lead free: Rosin. 9.5%<br>Temperature ramp/immersion and immersion rate: 25±6 mm/s<br>Dip time: 10±1sec.<br>Depth: completely cover the termination.<br>  |           |                           |                          |           |                           |     |       |     |           |      |      |     |   |           |      |
| Solderability                      | More than 95% of the terminal electrode should be covered with solder.<br>  | Preheat: 150°C,60sec.<br>Solder: Sn99.5%-Cu0.5%<br>Solder temperature: 245±5°C<br>Flux for lead free: Rosin. 9.5%<br>Depth: completely cover the termination.<br>Dip time: 4±1sec.   |           |                           |                          |           |                           |     |       |     |           |      |      |     |   |           |      |
| Terminal strength                  | Appearance : No damage.<br>Impedance : within±15% of initial value<br>Inductance : within±10% of initial value<br>Q : Shall not exceed the specification value.<br>RDC : within ±15% of initial value and shall not exceed the specification value<br> | Preconditioning: Run through IR reflow for 2 times.( IPC/JEDEC J-STD-020D Classification Reflow Profiles)<br>Component mounted on a PCB apply a force (>0805:1kg <=0805:0.5kg)to the side of a device being tested. This force shall be applied for 60 +1 seconds. Also the force shall be applied gradually as not to shock the component being tested.   |           |                           |                          |           |                           |     |       |     |           |      |      |     |   |           |      |
| Bending                            | Appearance : No damage.<br>Impedance : within±10% of initial value<br>Inductance : within±10% of initial value<br>Q : Shall not exceed the specification value.<br>RDC : within ±15% of initial value and shall not exceed the specification value   | Shall be mounted on a FR4 substrate of the following dimensions:>=0805:40x100x1.2mm<br><0805:40x100x0.8mm<br>Bending depth:>=0805:1.2mm<br><0805:0.8mm<br>Duration of 10 sec for a min.  |           |                           |                          |           |                           |     |       |     |           |      |      |     |   |           |      |
| Vibration Test                     | Appearance : No damage.<br>Impedance : within±15% of initial value<br>Inductance : within±10% of initial value<br>Q : Shall not exceed the specification value.<br>RDC : within ±15% of initial value and shall not exceed the specification value   | Preconditioning: Run through IR reflow for 2 times.( IPC/JEDEC J-STD-020D Classification Reflow Profiles)<br>Oscillation Frequency: 10~2K~10Hz for 20 minutes<br>Equipment : Vibration checker<br>Total Amplitude:1.52mm±10%<br>Testing Time : 12 hours(20 minutes, 12 cycles each of 3 orientations) °  |           |                           |                          |           |                           |     |       |     |           |      |      |     |   |           |      |
| Shock                              | Appearance : No damage.<br>Impedance : within±15% of initial value<br>Inductance : within±10% of initial value<br>Q : Shall not exceed the specification value.<br>RDC : within ±15% of initial value and shall not exceed the specification value   | Test condition:<br><table border="1"> <thead> <tr> <th>Type</th> <th>Peak Value (g's)</th> <th>Normal duration (D) (ms)</th> <th>Wave form</th> <th>Velocity change (V)ft/sec</th> </tr> </thead> <tbody> <tr> <td>SMD</td> <td>1,500</td> <td>0.5</td> <td>Half-sine</td> <td>15.4</td> </tr> <tr> <td>Lead</td> <td>100</td> <td>6</td> <td>Half-sine</td> <td>12.3</td> </tr> </tbody> </table> | Type      | Peak Value (g's)          | Normal duration (D) (ms) | Wave form | Velocity change (V)ft/sec | SMD | 1,500 | 0.5 | Half-sine | 15.4 | Lead | 100 | 6 | Half-sine | 12.3 |
| Type                               | Peak Value (g's)   | Normal duration (D) (ms)   | Wave form | Velocity change (V)ft/sec |                          |           |                           |     |       |     |           |      |      |     |   |           |      |
| SMD                                | 1,500  | 0.5  | Half-sine | 15.4                      |                          |           |                           |     |       |     |           |      |      |     |   |           |      |
| Lead                               | 100  | 6  | Half-sine | 12.3                      |                          |           |                           |     |       |     |           |      |      |     |   |           |      |

| Item                  | Performance   | Test Condition   |
|-----------------------|---|--|
| Life test             | Appearance: no damage.<br>Impedance: within±15%of initial value.<br>Inductance: within±10%of initial value.<br>Q : Shall not exceed the specification value.<br>RDC : within ±15% of initial value and shall not exceed the specification value | Preconditioning: Run through IR reflow for 2 times.( IPC/JEDEC J-STD-020D Classification Reflow Profiles)<br>Temperature: 125±2°C (bead), 85±2°C (inductor)<br>Applied current: rated current.<br>Duration: 1000±12hrs.<br>Measured at room temperature after placing for 24±2 hrs.                      |
| Load Humidity         |   | Preconditioning: Run through IR reflow for 2 times.( IPC/JEDEC J-STD-020D Classification Reflow Profiles)<br>Humidity: 85±2%R.H.<br>Temperature: 85±2°C.<br>Duration: 1000hrs Min. with 100% rated current.<br>Measured at room temperature after placing for 24±2 hrs.                                  |
| Thermal shock         | Appearance: no damage.<br>Impedance: within±15%of initial value.<br>Inductance: within±10%of initial value.<br>Q : Shall not exceed the specification value.<br>RDC : within ±15% of initial value and shall not exceed the specification value | Preconditioning: Run through IR reflow for 2 times.( IPC/JEDEC J-STD-020D Classification Reflow Profiles)<br>Condition for 1 cycle<br>Step1: -40±2°C 30±5 min.<br>Step2: 25±2°C ≤0.5min<br>Step3: +105±2°C 30±5min.<br>Number of cycles: 500<br>Measured at room temperature after placing for 24±2 hrs. |
| Insulation Resistance | IR>1GΩ  | Chip Inductor Only<br>Test Voltage:100±10%V for 30Sec.   |

**\*\*Derating Curve**

For the ferrite chip bead which withstanding current over 1.5A, as the operating temperature over 85°C, the derating current information is necessary to consider with. For the detail derating of current, please refer to the Derated Current vs. Operating Temperature curve.

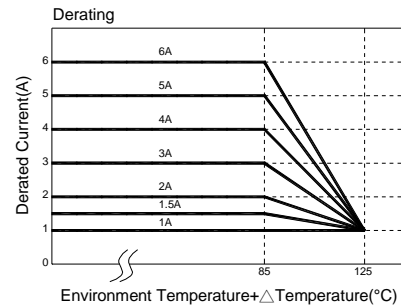

**Soldering and Mounting**

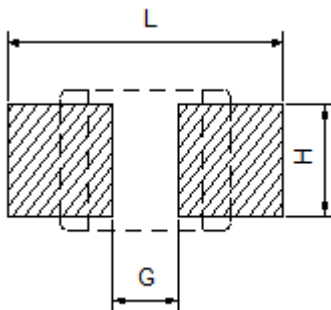

|                | L (mm)      | G (mm)      | H (mm)      |
|----------------|-------------|-------------|-------------|
| <b>WLF2012</b> | <b>3.00</b> | <b>1.00</b> | <b>1.00</b> |

### Soldering

Mildly activated rosin fluxes are preferred. The terminations are suitable for re-flow soldering systems. If hand soldering cannot be avoided, the preferred technique is the utilization of hot air soldering tools.

Note. If wave soldering is used, there will be some risk.  
Re-flow soldering temperatures below 240 degrees, there will be non-wetting risk

### Lead Free Solder re-flow

Recommended temperature profiles for lead free re-flow soldering in Figure 1. (Referred to J-STD-020C)

### Soldering Iron:

Products attachment with a soldering iron is discouraged due to the inherent process control limitations. If a soldering iron must be employed the following precautions are recommended. for Iron Soldering in Figure 2.

- Preheat circuit and products to 150°C
- Never contact the ceramic with the iron tip
- Use a 20 watt soldering iron with tip diameter of 1.0mm
- 350°C tip temperature (max)
- 1.0mm tip diameter (max)
- Limit soldering time to 4~5sec.

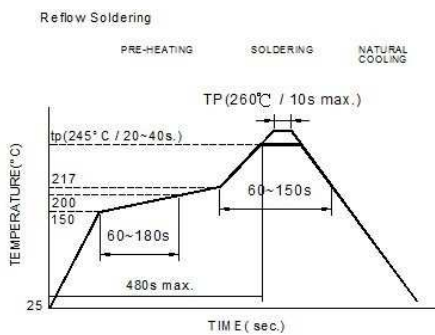

Reflow times: 3 times max.  
Fig.1

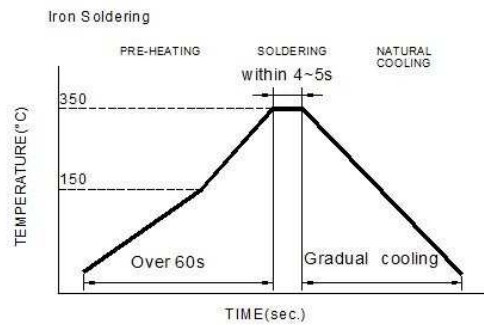

Iron Soldering times : 1 times max.  
Fig.2

### Packaging Specification

Material of taping is paper

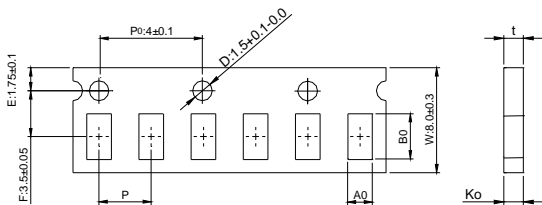

| Size   | Bo(mm)    | Ao(mm)    | Ko(mm)    | P(mm)    | t(mm)     |
|--------|-----------|-----------|-----------|----------|-----------|
| 060303 | 0.70±0.06 | 0.40±0.06 | 0.45max   | 2.0±0.05 | 0.45max   |
| 100505 | 1.12±0.03 | 0.62±0.03 | 0.60±0.03 | 2.0±0.05 | 0.60±0.03 |

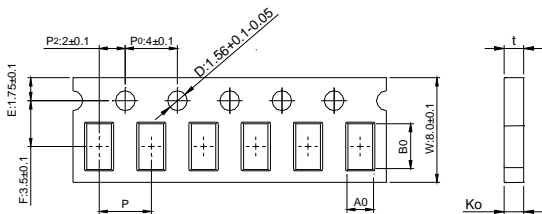

| Size   | Bo(mm)    | Ao(mm)          | Ko(mm)    | P(mm)    | t(mm)     |
|--------|-----------|-----------------|-----------|----------|-----------|
| 160808 | 1.80±0.05 | 0.96+0.05/-0.03 | 0.95±0.05 | 4.0±0.10 | 0.95±0.05 |
| 201209 | 2.10±0.05 | 1.30±0.05       | 0.95±0.05 | 4.0±0.10 | 0.95±0.05 |

Material of taping is plastic

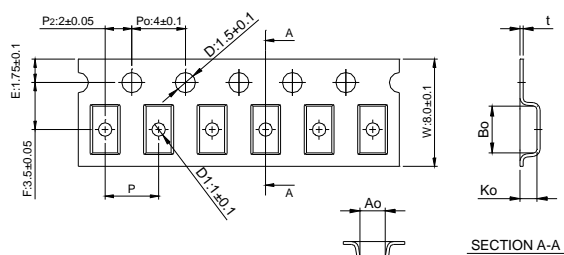

| Size   | Bo(mm)    | Ao(mm)    | Ko(mm)    | P(mm)    | t(mm)     | D1(mm)   |
|--------|-----------|-----------|-----------|----------|-----------|----------|
| 201212 | 2.10±0.10 | 1.28±0.10 | 1.28±0.10 | 4.0±0.10 | 0.22±0.05 | 1.0±0.10 |
| 321611 | 3.35±0.10 | 1.75±0.10 | 1.25±0.10 | 4.0±0.10 | 0.23±0.05 | 1.0±0.10 |
| 322513 | 3.42±0.10 | 2.77±0.10 | 1.55±0.10 | 4.0±0.10 | 0.22±0.05 | 1.0±0.10 |
| 321609 | 3.40±0.10 | 1.77±0.10 | 1.04±0.10 | 4.0±0.10 | 0.22±0.05 | 1.0±0.10 |

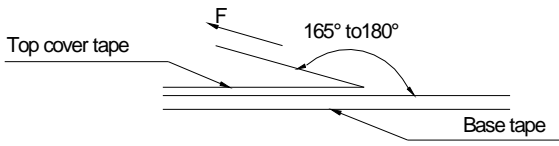

The force for tearing off cover tape is 15 to 60 grams in the arrow direction under the following conditions

| Room Temp. (°C) | Room Humidity (%) | Room atm (hPa) | Tearing Speed mm/min |
|-----------------|-------------------|----------------|----------------------|
| 5~35            | 45~85             | 860~1060       | 300                  |

Products meet IPC/JEDEC J-STD-020D standard-MSL, level 1.

Quantity per reel : Thickness C size (mm) - 0.85mm, 4k pcs / reel ; 1.25mm, 2k pcs / reel