



PT30Z54 V2

Product Specification

Approval Sheet

PT30Z54 V2

Product Specification



Product	White SMD LED
Part Number	PT30Z54 V2
Issue Date	2018/05/11

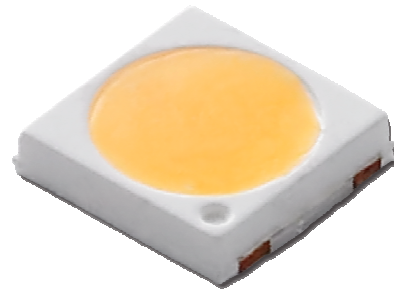

■ Features

- ✓ White SMD LED (L x W x H) of 3.2 x 3.0 x 0.6 mm
- ✓ AEC-Q101 Rev. D and IEC 60810 qualification
- ✓ Dice Technology : InGaN
- ✓ Qualified according to JEDEC moisture sensitivity Level 2
- ✓ Cu Alloy with Gold plated lead frame
- ✓ Environmental friendly ; RoHS compliance
- ✓ ESD protection
- ✓ Packing : 1,000 / 2,000 / 3,000 pcs/reel

■ Applications

- ✓ DRL (Daytime Running Light)
- ✓ Position light

Outline Dimension

PT30Z54 V2

Product Specification

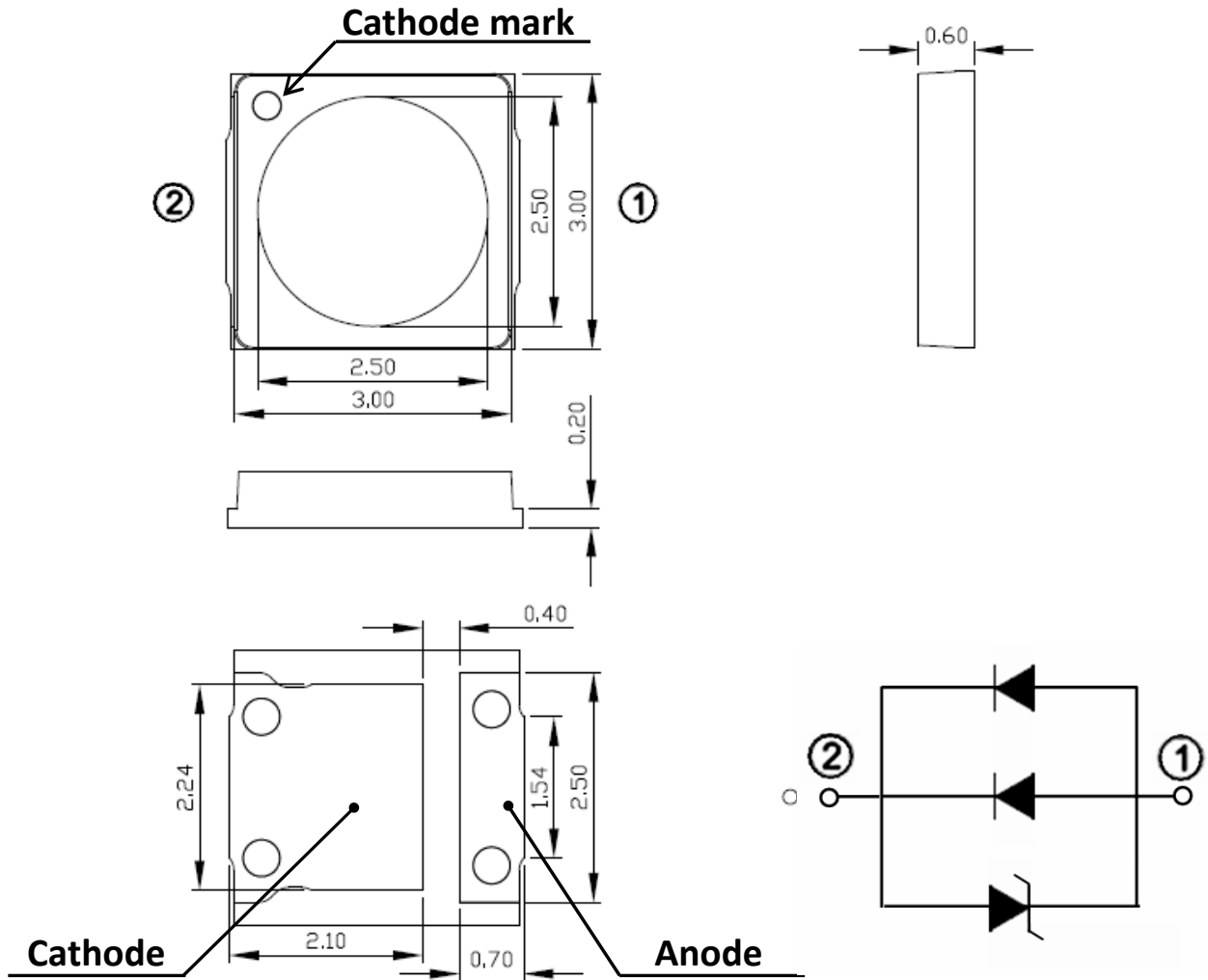

Unit: mm, Tolerance: $\pm 0.1\text{mm}$

Recommended Soldering Pad

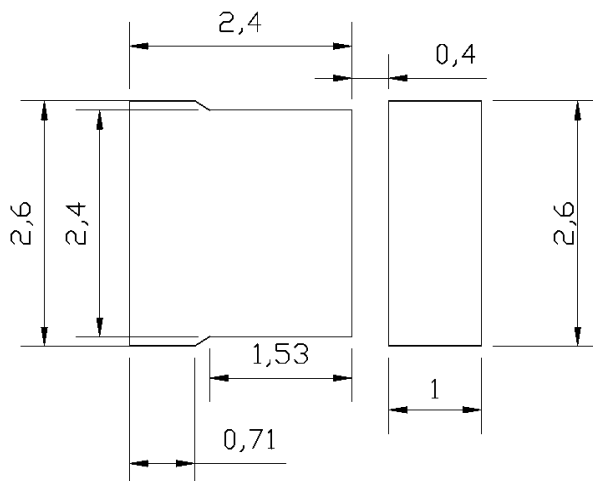

Performance

PT30Z54 V2

Product Specification

■ Electro-Optical Characteristics (Ta=25°C)

Parameter	Symbol	Condition	Min.	Typ.	Max.	Unit
Forward Voltage	V_F	$I_F = 350 \text{ mA}$	3.0	3.2	3.6	V
Luminous Flux	Φ_v		-	110	-	lm
View Angle	θ		120			deg
Thermal Resistance	R_{th}		15			°C/W

* The Forward Voltage tolerance is $\pm 0.05\text{V}$

* The luminous intensity tolerance is $\pm 8\%$

* Tolerance of measurements of the Chromaticity Coordinate is ± 0.005 .

■ Absolute Maximum Ratings

Parameter	Symbol	value	Unit
DC Forward Current ⁽¹⁾	I_F	450	mA
Power Dissipation	P_D	1.7	W
Pulse Forward Current ⁽²⁾	I_{FP}	600	mA
Storage Temperature	T_{stg}	-40 ~ +105	°C
Operating Temperature	T_{opr}	-40 ~ +105	°C
Junction Temperature	T_J	125	°C
ESD (HBM)	ESD_{HBM}	8000	V
Assembly Temperature	T_{sld}	260	°C

(1) Proper current rating must be observed to maintain junction temperature below maximum at all time

(2) IFP Condition: Duty 1/10, Pulse within 10msec

Binning

PT30Z54 V2

Product Specification

Chromaticity Coordinates

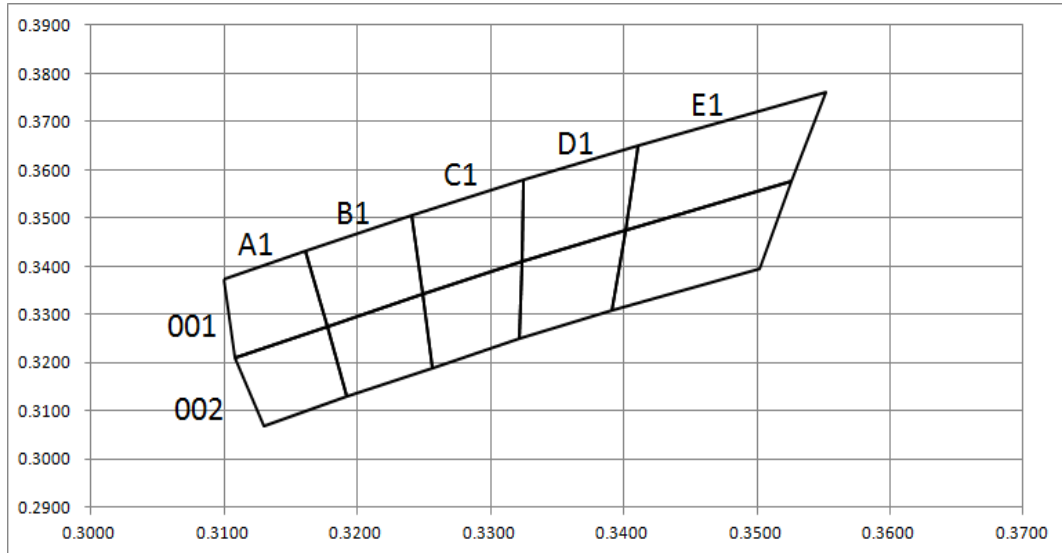

Bin code definition

V _F Rank	Luminous Flux Rank	CIE Rank
A	VT	A1001

V _F Rank	Condition	Min.	Max.
A	I _F = 350 mA T _j = 25°C	3.0	3.2
B		3.2	3.4
C		3.4	3.6

Luminous Flux Rank	Condition	Min.	Max.
VS	I _F = 350 mA T _j = 25°C	104.5	115.0
VT		115.0	126.5
VU		126.5	139.2

CIE rank	CIE X	CIE Y	CIE rank	CIE X	CIE Y
A1001	0.3100	0.3375	B1001	0.3161	0.3431
	0.3161	0.3431		0.3241	0.3505
	0.3177	0.3276		0.3249	0.3343
	0.3108	0.321		0.3177	0.3276
A1002	0.3108	0.321	B1002	0.3177	0.3276
	0.3177	0.3276		0.3249	0.3343
	0.3192	0.313		0.3256	0.319
	0.313	0.3069		0.3192	0.313
C1001	0.3241	0.3505	D1001	0.3325	0.3579
	0.3325	0.3579		0.3411	0.3651
	0.3324	0.341		0.3401	0.3475
	0.3249	0.3343		0.3324	0.341
C1002	0.3249	0.3343	D1002	0.3324	0.341
	0.3324	0.341		0.3401	0.3475
	0.3322	0.325		0.3391	0.331
	0.3256	0.319		0.3322	0.325
E1001	0.3411	0.3651	E1002	0.3401	0.3475
	0.3552	0.376		0.3526	0.3578
	0.3526	0.3578		0.3502	0.3396
	0.3401	0.3475		0.3391	0.3310

* The Forward Voltage tolerance is $\pm 0.05V$

* The luminous intensity tolerance is $\pm 8\%$

* Tolerance of measurements of the Chromaticity Coordinate is ± 0.005 .

Characteristics

PT30Z54 V2

Product Specification

Spectrum

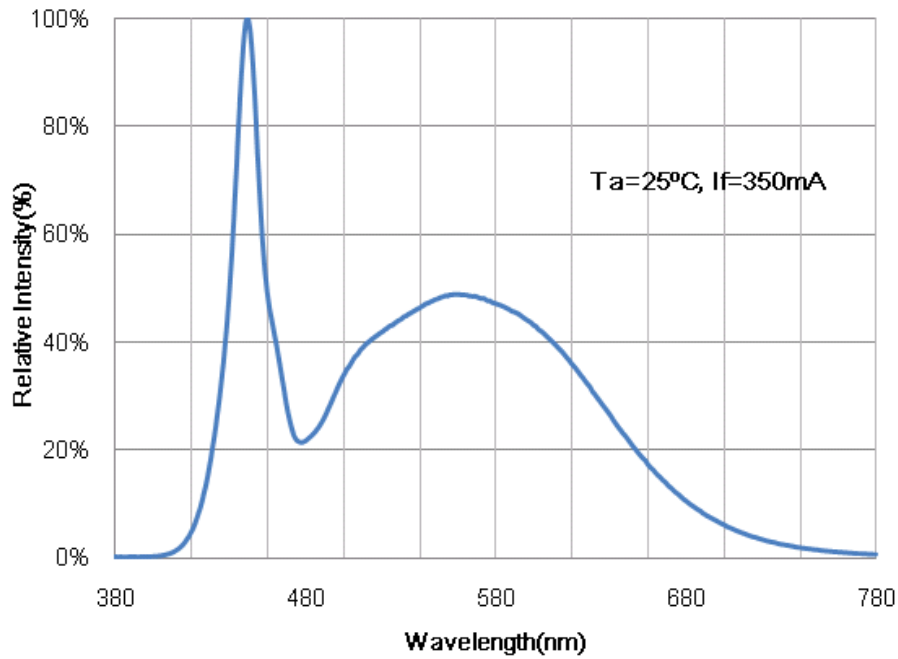

Radiation Pattern

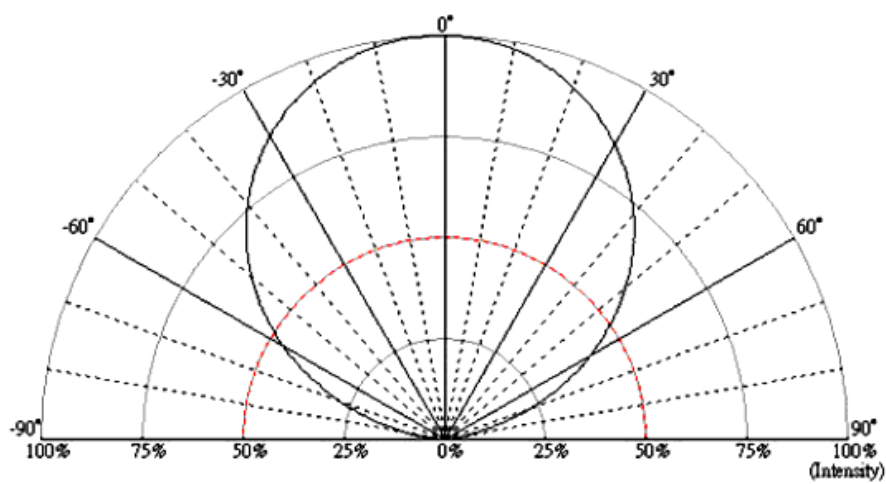

■ Forward Voltage vs. Forward Current

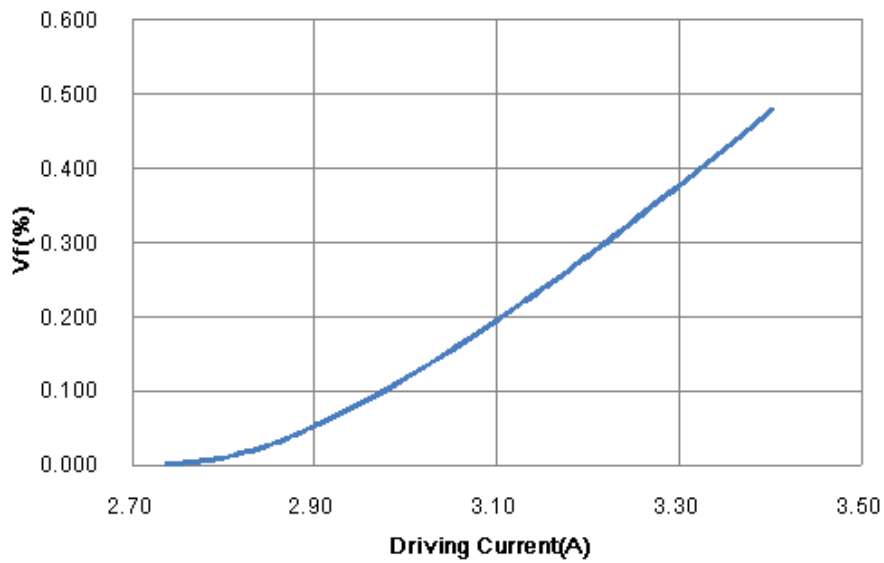

■ Forward Current vs. Relative Luminosity

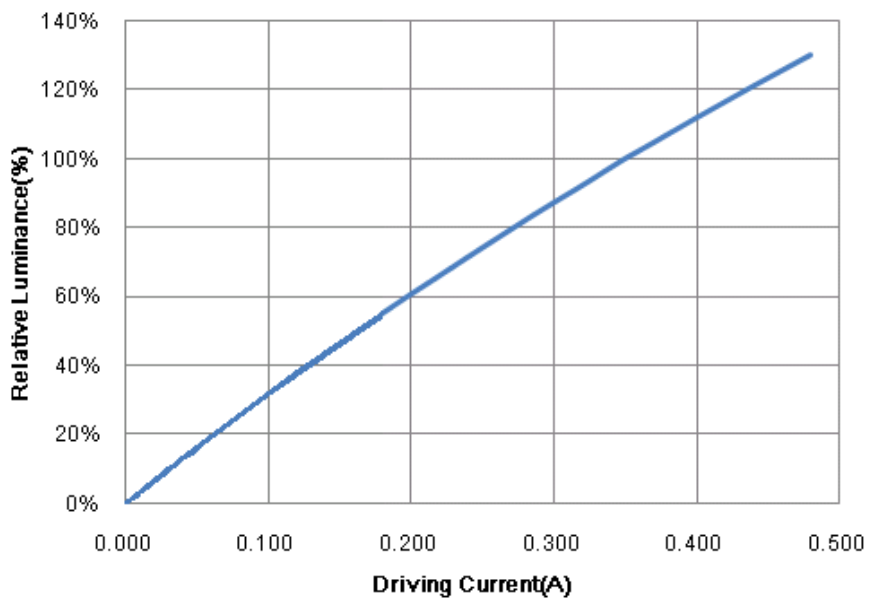

■ Forward Current vs. Chromaticity Coordinate

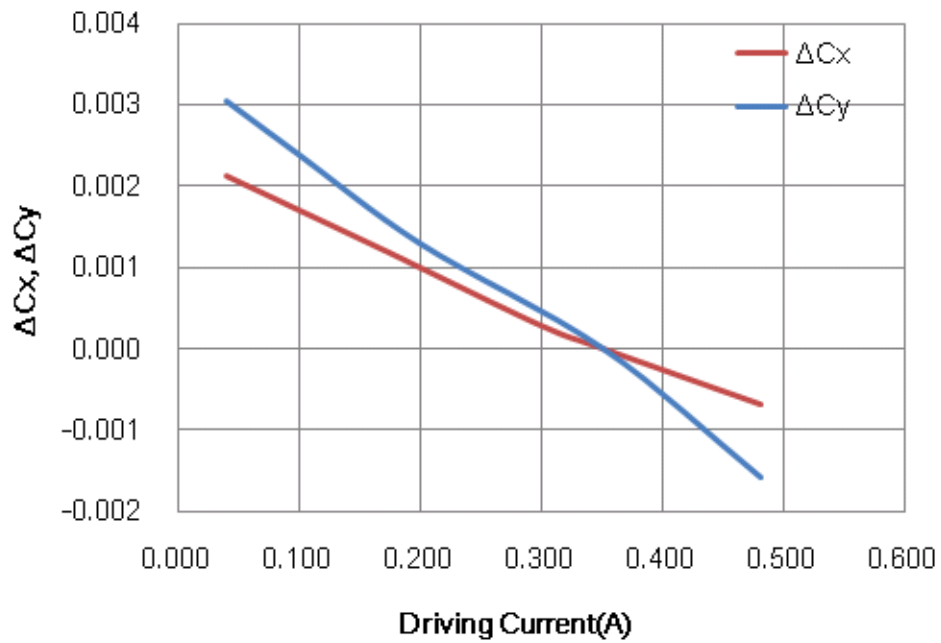

■ Relative Forward Voltage vs. Ambient Temperature

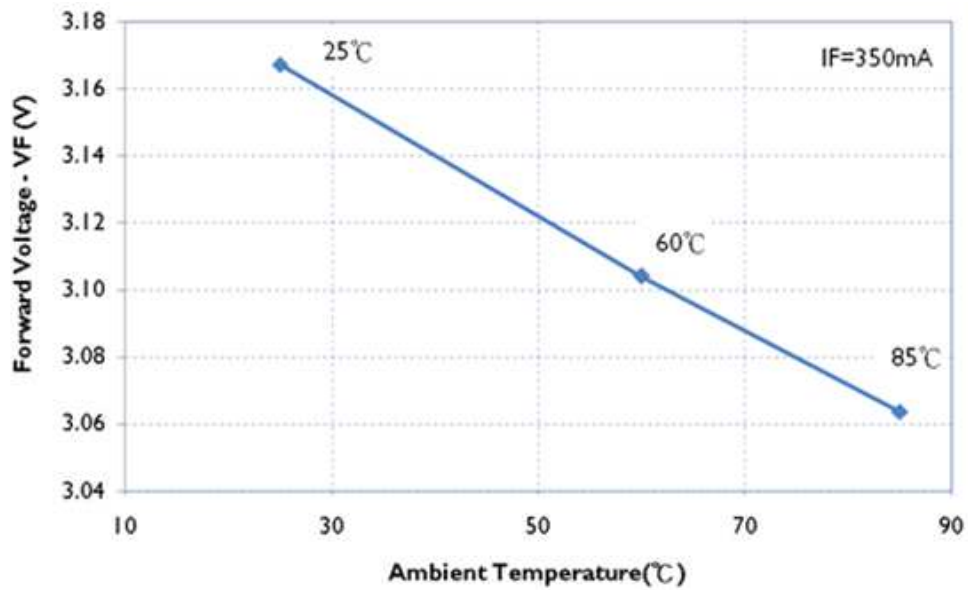

■ **Relative Luminous Intensity vs. Ambient Temperature**

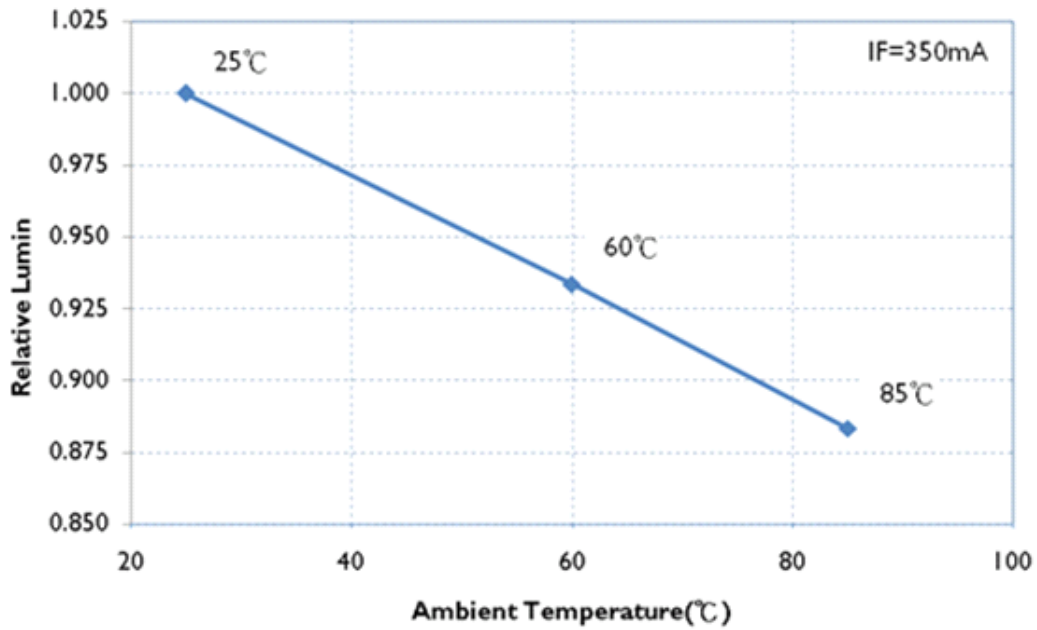

■ **Chromaticity vs. Ambient Temperature**

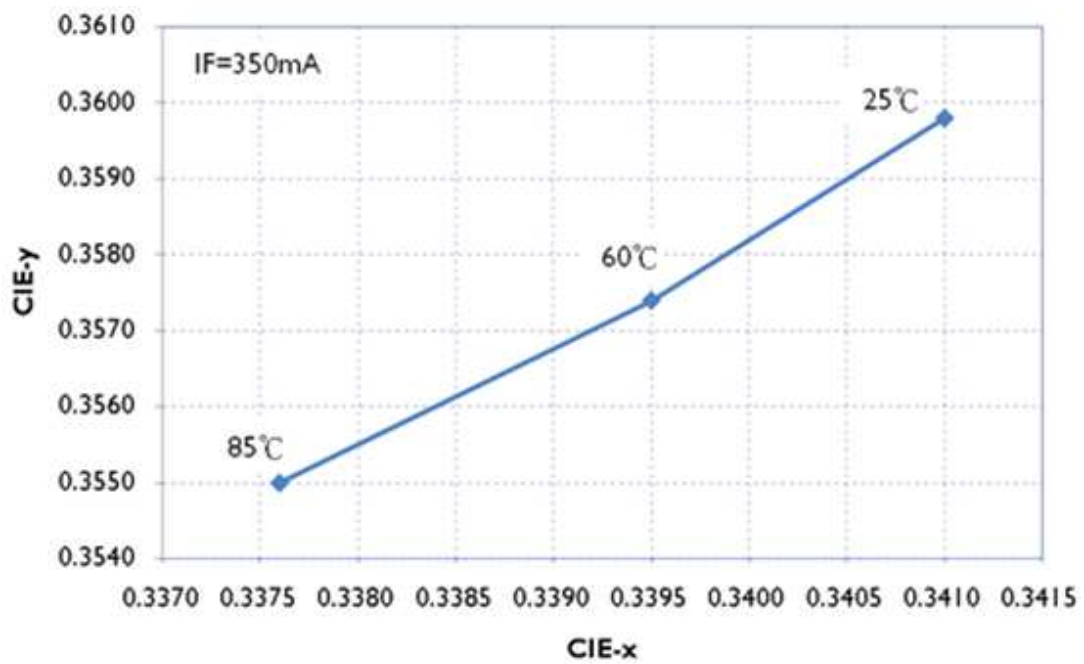

Reliability

PT30Z54 V2
 Product Specification

Reliability test

	Item	Reference Standard	Condition	Time/Cycle
1	Thermal shock	JESD22-A106	-40°C to 125 °C, 20 mins dwell, 5 min transfer time	1000 Cycles
2	Temperature Cycle	AEC-Q101 Rev. D	-55°C to 125 °C 15 mins dwell at each high and low temperature extreme	1000 cycles
3	Power and Temperature Cycle	AEC-Q101 Rev. D	-40 °C ~ 125 °C, IF=450mA, Dwell/transfer time = 10 mins, 20 mins 1,000 cycles , on/off 15,000 cycles	15,000 cycles
4	MSL Level 2	J-STD-020	85°C / 60% RH	168 hours
5	High Temperature Storage	JESD22-A103	TA=105°C, 1000hrs	1000 hours
6	Low Temperature Storage	JESD22-A119	TA=-40°C, 1000hrs	1000 hours
7	High Temperature Operating Life	AEC-Q101 Rev. D	TA=105°C, IF=450mA	1000 hours
8	Low Temperature Operating Life	JESD22-A108	TA=-40°C, IF=450mA	1000 hours
9	Temperature Humidity Operating Life	AEC-Q101 Rev. D	85°C, RH=85%, 1000hrs, IF=450mA	1000 hours
10	Electrostatic Discharges	AEC-Q101 Rev. D	HBM 8 KV, 1.5KΩ, 100pF, 3 pulses, alternately positive or negative	

Item	Reference Standard	Condition	Time
Corrosion robustness	IEC 60068-2-43	(H2S) [25°C / 75 %RH / 10 ppm H ₂ S]	336 hours
	EN60068-2-60	[25 °C / 75 %RH / 200 ppb SO ₂ , 200 ppb NO ₂ ,10 ppb Cl ₂]	504 hours

Judgment Criteria

Item	Symbol	Test Condition	Judgment Criteria
Forward Voltage	V _f	350mA	ΔV _f < 10 %
Luminous Flux	I _v	350mA	ΔI _v < 20 %
Delta CIE	CIE-x ,CIE-y	350mA	Δx,y <0.01

Packing

PT30Z54 V2
Product Specification

Label

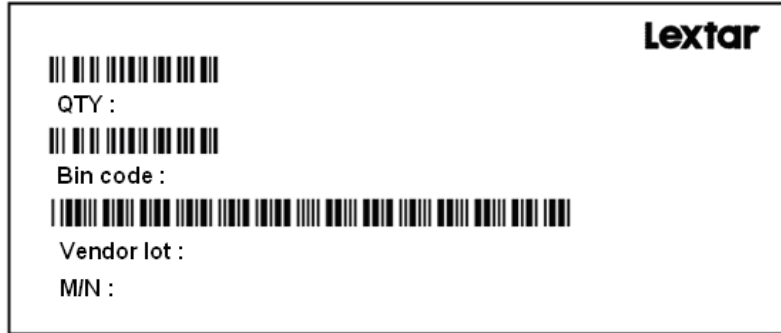

Carrier Taping

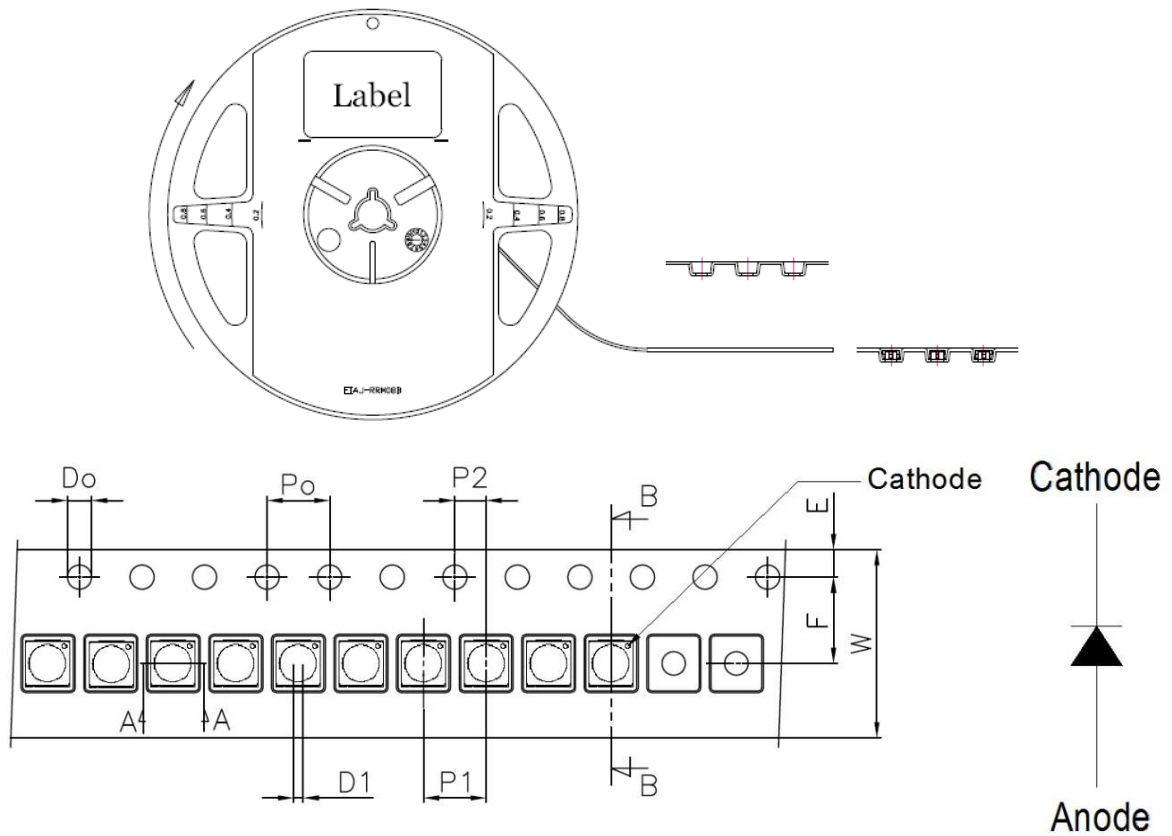

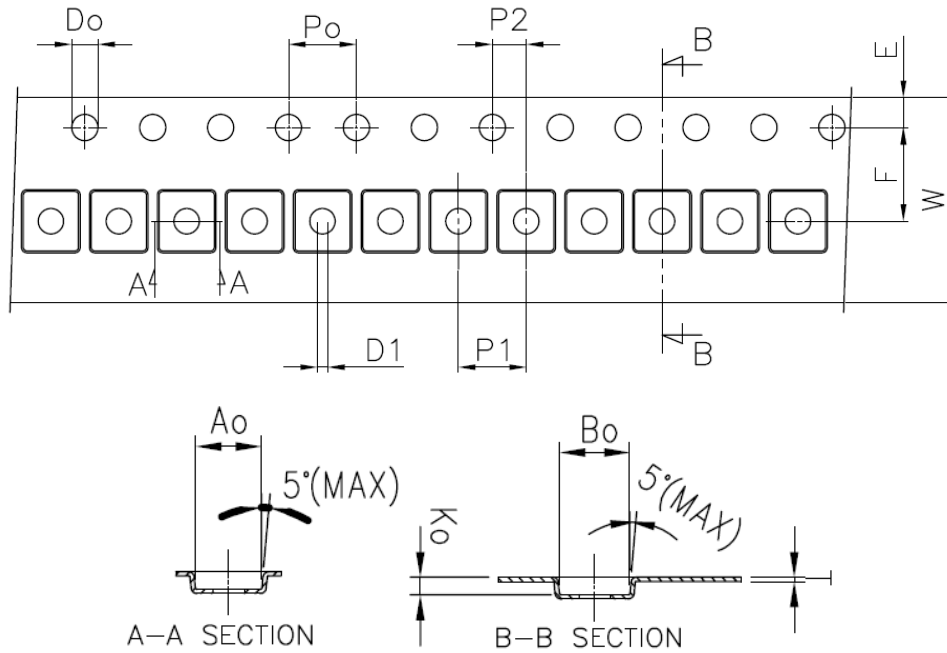

Unit:mm

symbol	Ao	Bo	Ko	Po	P1	P2	T
spec	3.25±0.10	3.50±0.10	0.78±0.10	4.00±0.10	4.00±0.10	2.00±0.05	0.20±0.05
symbol	E	F	Do	D1	W	10Po	
spec	1.75±0.10	5.50±0.05	1.50 ^{+0.10} ₀	1.50±0.10	12.0±0.30	40.00±0.20	

Notice:

1. 10 Sprocket hole pitch cumulative tolerance is ± 0.20 mm.
2. Carrier camber shall be not more than 1mm per 100mm through a length of 250mm.
3. Ao & Bo measured on a place in the middle of the corner radii.
4. Ko measured from a place on the inside bottom of the pocket to top surface of carrier.
5. Pocket position relative to sprocket hole measured as true position of pocket, not pocket hole.
6. Surface resistivity $10^4 \sim 10^8$ ohm/sq.

■ **Shield Bag Taping**

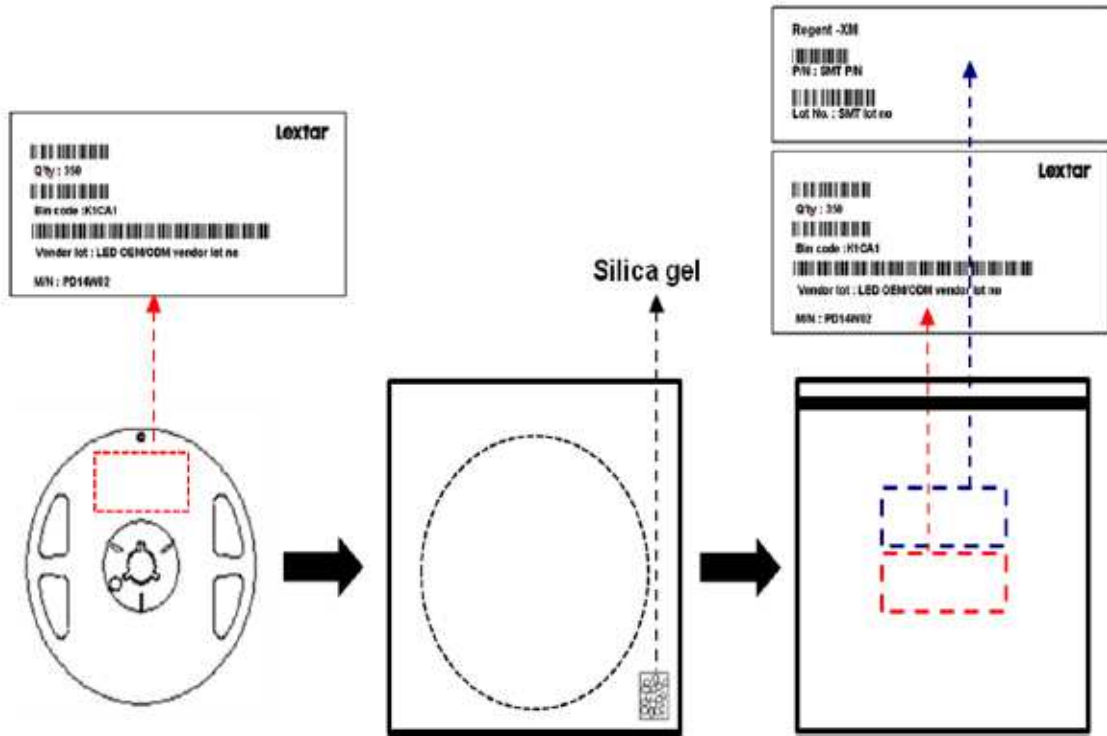

■ **Packing Box**

Type	Large Box		Medium Box		Small Box	
Dimension	541X511X276mm		385X303X260mm		283X235x70mm	
Maximum Reels	7"X12mm Reel	64/R	7"X12mm Reel	21/R	7"X12mm Reel	4/R
Minimum Reels	7"X12mm Reel	32/R	7"X12mm Reel	9/R	7"X12mm Reel	1/R

■ **Small Box**

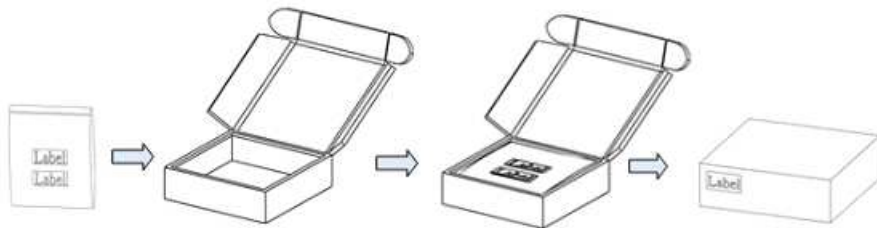

■ **Medium Box**

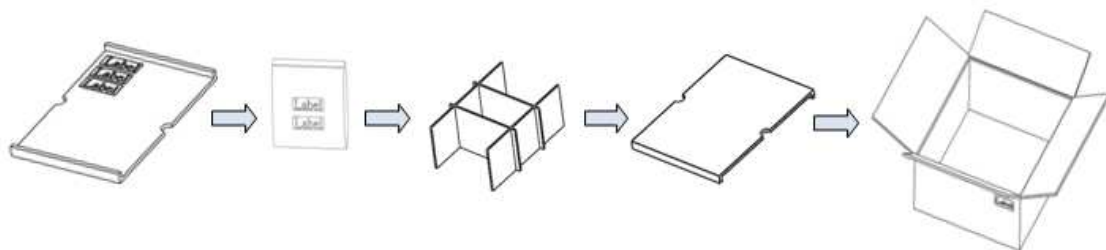

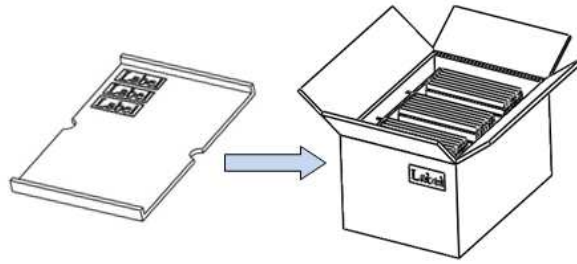

■ **Large Box**

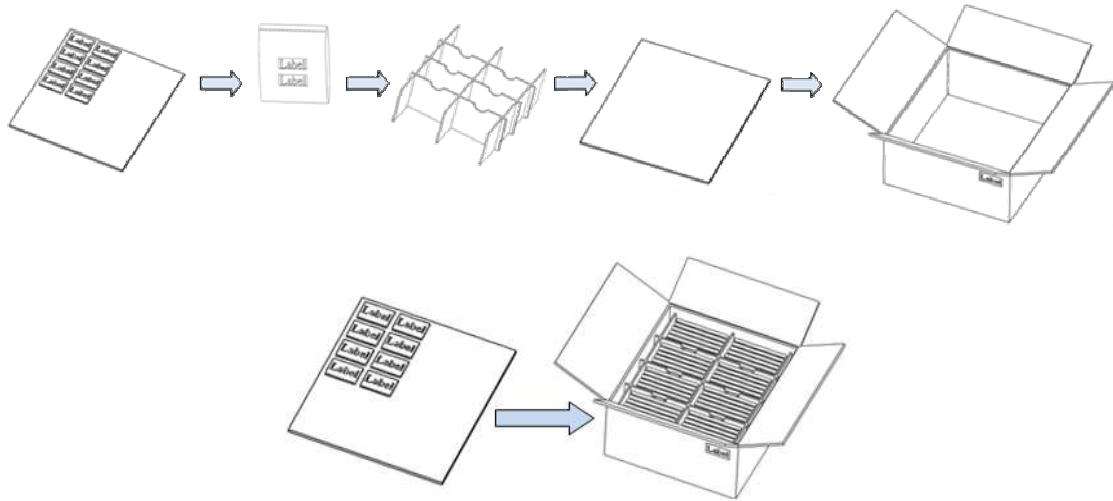

Precautions

PT30Z54 V2
Product Specification

■ Safety Precautions

- The LED light output is too strong for human eyes without shield. Prevent eye contact directly more than seconds.
- Ensure operating under maximum rating.

■ Storage

- Before opening the package, the LEDs should storage under 30°C, 60% RH.
- After opening the package bag, the LEDs should be keep under 30°C, 60% RH. Recommend to use within 168 hrs. If unused LEDs remain, suggest to store into moisture proof bag or original package bag with moisture absorbent material such as silica gel. Reseal well is necessary.
- If the product exceeded the storage period or the moisture absorbent material faded away, baking treatment should be done by following conditions.
Bake condition: 60°C, 12hours (One time only).

■ Soldering Notice and Conditions

When soldering LEDs,

- Do not solder/reflow the same LED over two times.
- Reflow temperature profile as below: (lead-free solder)

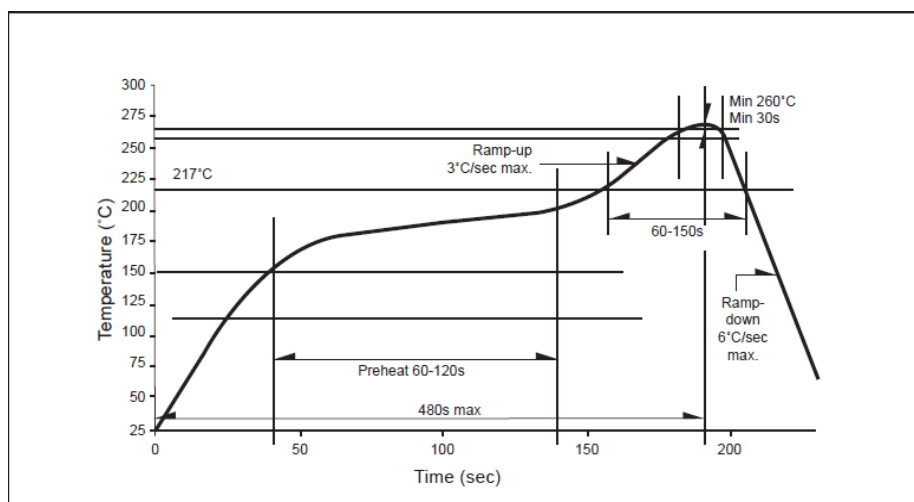

Classification Reflow Profile (JEDEC J-STD-020D)

- When soldering, don't put stress on the LEDs
- After LEDs have been soldered, strongly recommend not to repair to keep the LEDs performance.

■ Static Electricity

- LED package is extremely sensitive to static electricity. It's recommended that anti-electrostatic glove and wrist band is necessary when handling the LEDs. All devices are also be grounded properly as well.
- Protection devices design should be considered in the LED driving circuit.

■ Cleaning

- If washing is required, recommend to use alcohol as a solvent.
- Recommend to avoid cleaning the LEDs by ultrasonic. If necessary, pre-test the LED is necessary to confirm whether any damage occur after the process.

Revision History

PT30Z54 V2
Product Specification

Date	Contents	Writer	Approved
2014.12.15	Preliminary version	Vincent Huang	
2017.1.19	Update the Flux Rank	SK Chen	Peter Chou
2017.08.07	1. Update features Cu Alloy with Gold plated LF – P.2 2. Update Reliability test – P.11 3. Soldering Notice and Conditions – P.15	Kelly	Bemore
2018.02.08	Add Rth – P.4	Ray	Bemore
2018.02.22	Update Binning (Add E1 bin) – P.5~6	Ray	Bemore
2018.05.11	LED placed into carrier tape definition – P.12	Rudess	Bemore

Smart Lighting *Amazing Life*

Lextar Electronics Corp. is the leading LED (Light Emitting Diode) maker integrating upper stream epitaxial, middle stream chip, and downstream package, SMT and LED lighting applications. Founded in May, 2008, Lextar is a subsidiary of AU Optronics, the leading TFT-LCD and solar PV manufacturer. Lextar's product applications include lighting and LCD backlight. Lextar's manufacturing sites include Hsinchu and Chunan in Taiwan, and Suzhou in China. The company turnover in 2010 is 266 million USD.