

2835A18-XXH10 -XX-XX Datasheet

This 2835 LED Light Source is a high performance energy efficient device which can handle high thermal and high driving current. The small package outline and high intensity make it an ideal choice for LED panel light, LED bulb light, LED tube light, backlighting and etc.

The White Power LED is available in the range of color temperature from 2600K to 7000K.

This part has a foot print that is compatible to most of the same size LED in the market today.

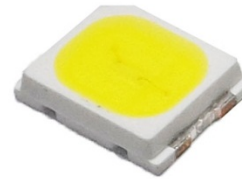

FEATURES

- Available in Cool White, Neutral White and Warm White color
- ANSI-compatible chromaticity bins
- High luminous Intensity and high efficiency
- Compatible with reflow soldering process
- Low thermal resistance
- Long operation life
- Wide viewing angle at 120°
- Silicone encapsulation
- Environmental friendly, RoHS compliance

APPLICATIONS

- Flat panel light
- Backlighting
- LED tube light
- LED bulb light
- Interior & exterior automotive lighting
- Decorative and landscape lighting
- Signage and channel letter
- Reading lamp
- Decorating and entertainment lighting
- Architectural lighting

Note: The information in this document is subject to change without notice.

PACKAGE DIMENSIONS

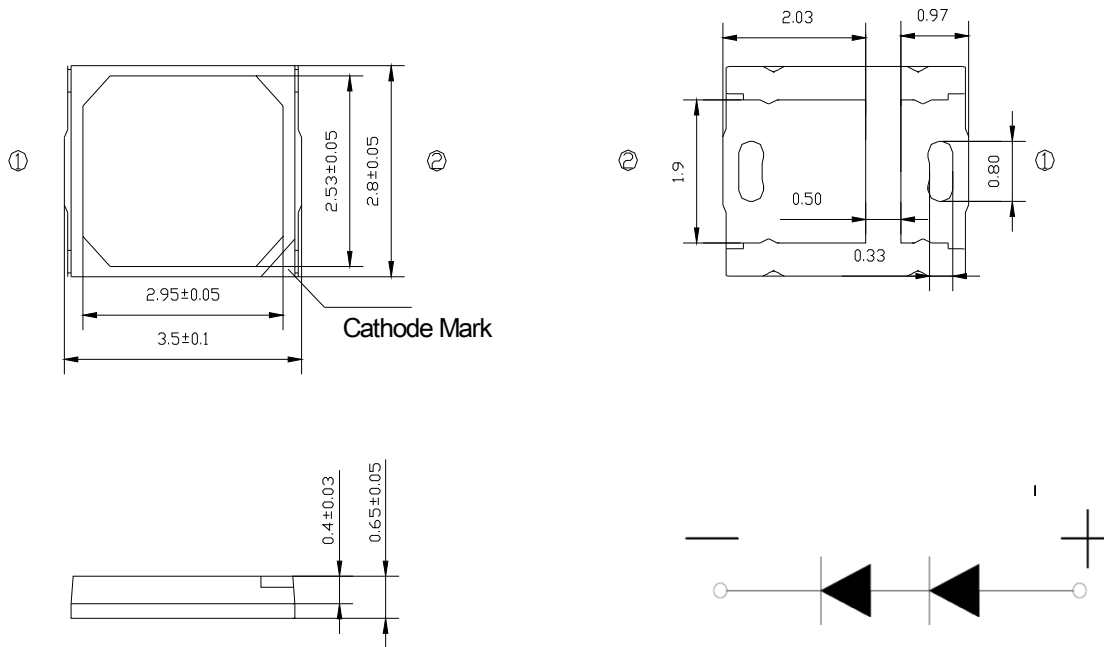

Recommended Solder Pad Design

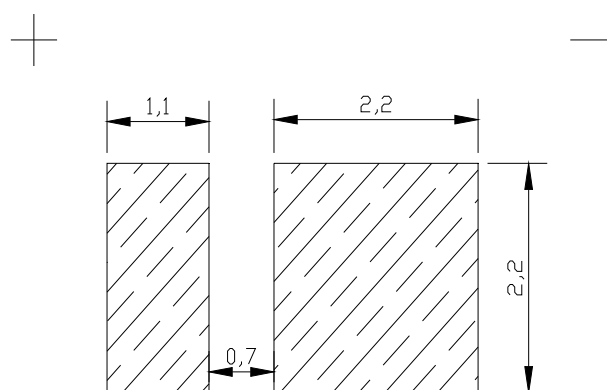

Notes:

1. All dimensions in millimeters.
2. Thickness tolerance of copper plate is ± 0.02 mm.
3. Thickness tolerance of product is ± 0.05 mm.
4. Tolerance is ± 0.1 mm unless otherwise noted.

ABSOLUTE MAXIMUM RATINGS

Item	Symbol	Absolute Maximum Rating	Unit
Forward current	I_F	60	mA
Peak Forward Current ^[1]	I_{FP}	90	mA
Reverse Voltage	V_R	30	V
Power Dissipation	P_d	1000	mW
Operating Temperature	T_{opr}	-40~+85	°C
Storage Temperature	T_{stg}	-40~+100	°C
Soldering Temperature	T_{sld}	Reflow Soldering: 260°C for 10 seconds	
LED Junction Temperature	T_j	110	°C

Note:

I_{FP} Conditions: Pulse Width \leq 10msec. and Duty \leq 1/10.

CHARACTERISTICS ($T_j=25^\circ\text{C}$)

Parameter	Symbol	Condition	Min	Typ	Max	Unit
Forward Voltage ^[1]	V_F	$I_F=60\text{mA}$	17	18.5	20	V
Viewing Angle	$2\theta_{1/2}$	$I_F=60\text{mA}$	--	120	--	deg.
Luminous Flux	Φ_v	$I_F=60\text{mA}$	120	--	170	lm
Color Rendering Index	CRI	$I_F=60\text{mA}$	80	--	--	--
Color Temperature	CCT	$I_F=60\text{mA}$	2600	--	7000	K
Thermal Resistance (Junction to Solder Point)	R_{th-js}	$I_F=60\text{mA}$	--	15	--	°C/W

Notes:

- Luminous flux is measured with an accuracy of $\pm 10\%$.
- Chromaticity coordinate bins are measured with an accuracy of ± 0.01 .
- CRI is measured with an accuracy of ± 2 .
- Some color and CRI bins may have limited availability, please contact us before ordering.
- All measurements were made under the standardized environment of Shineon

RELATIVE SPECTRAL POWER DISTRIBUTION ($T_j=25^\circ\text{C}$)

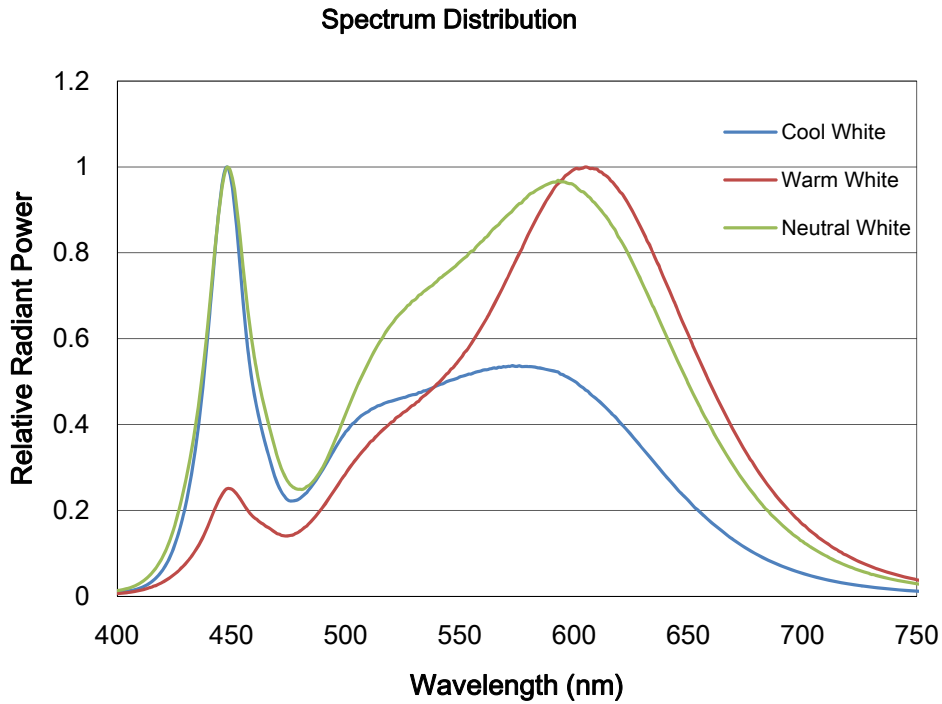

TYPICAL SPATIAL DISTRIBUTION

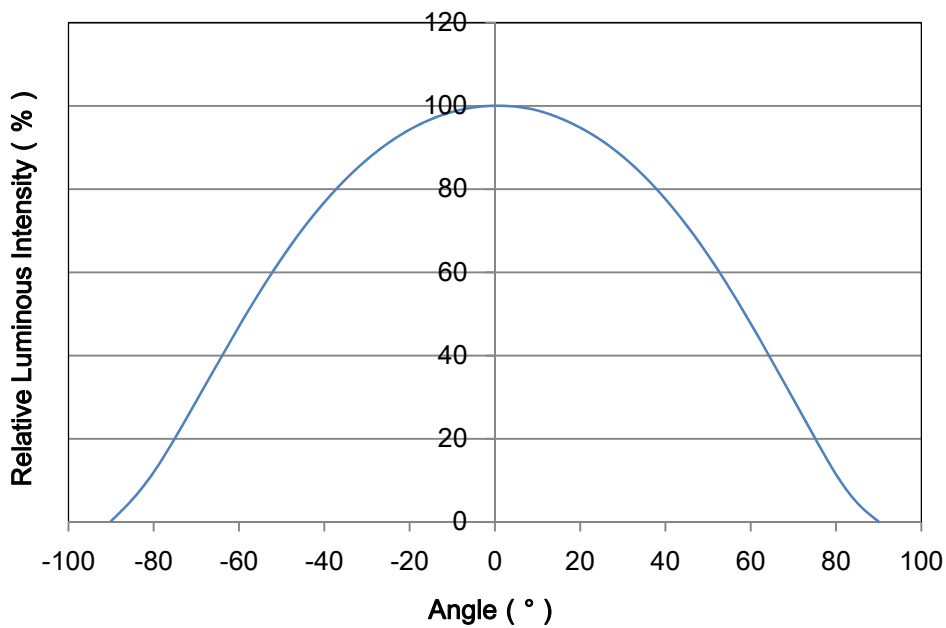

RELATIVE LUMINOUS FLUX VS. CURRENT ($T_j=25^\circ\text{C}$)

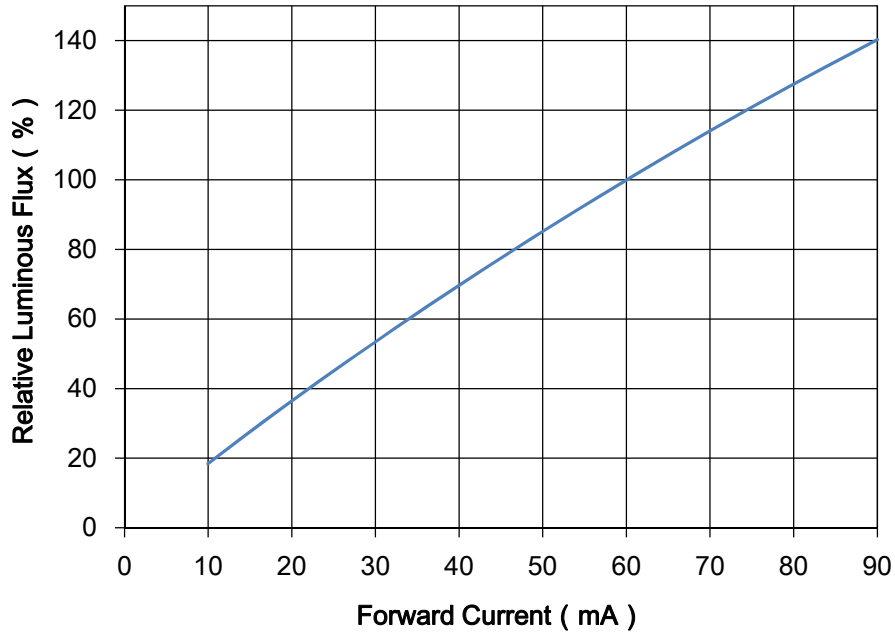

ELECTRICAL CHARACTERISTICS ($T_j=25^\circ\text{C}$)

Forward Current vs. Forward Voltage

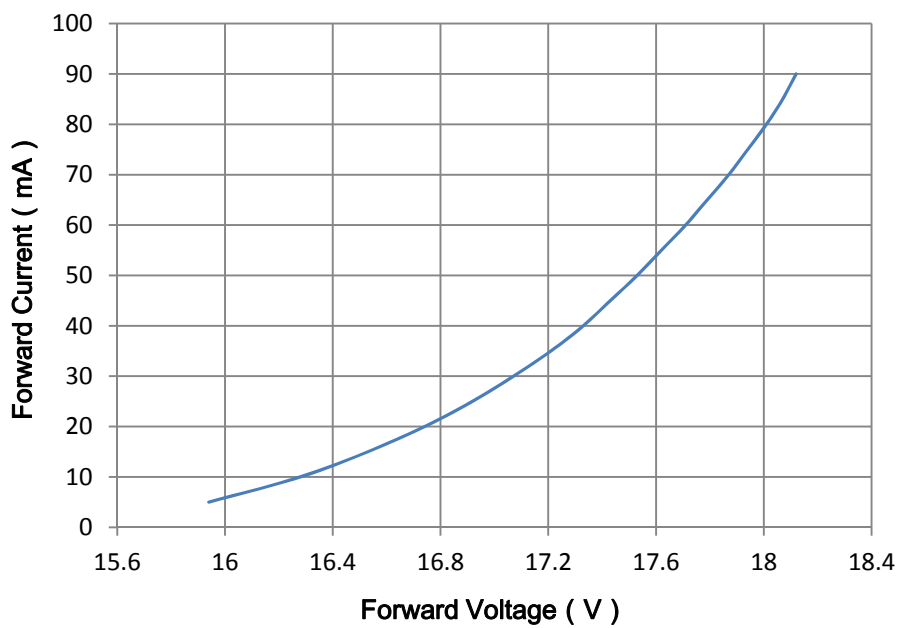

MAXIMUM CURRENT VS. AMBIENT TEMPERATURE

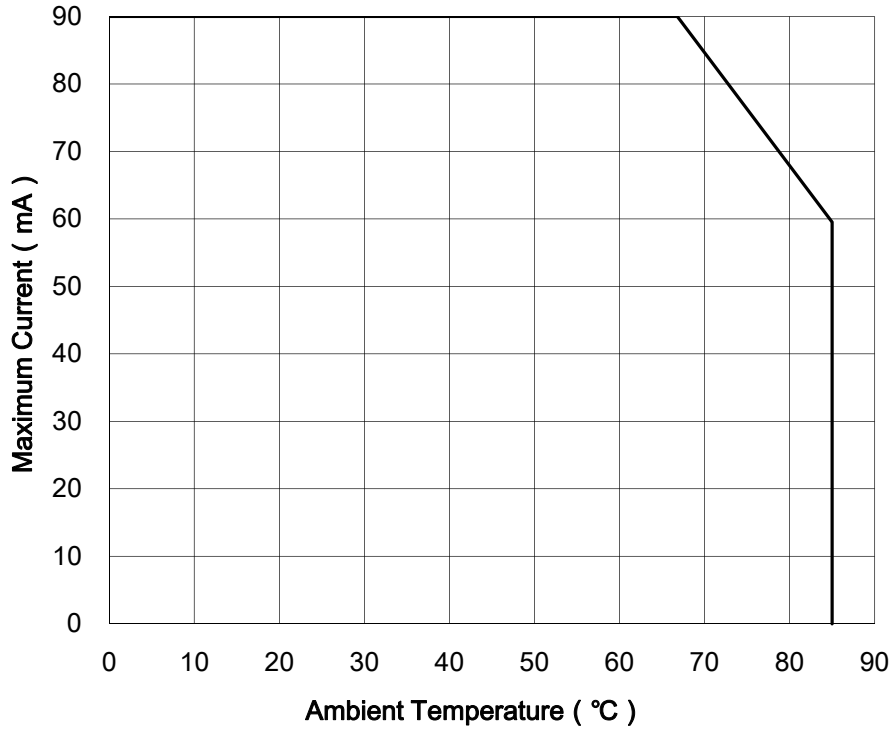

RELATIVE RADIANT FLUX VS. JUNCTION TEMPERATURE

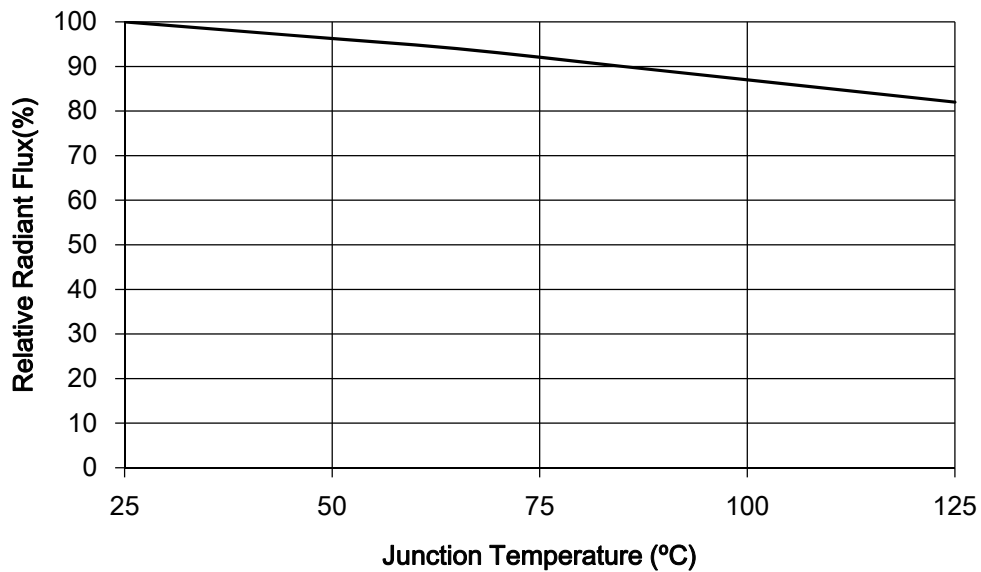

SORTING RANKS

(1) Luminous Flux (Tj=25°C)

Part Number	Condition	Rank						Unit
2835A18-27H10-XX-XX	60mA	QD	QE	QF	QG	Q4	Q5	lm
		120-125	125-130	130-135	135-140	140-150	150-160	
2835A18-30H10-XX-XX		QD	QE	QF	QG	Q4	Q5	
		120-125	125-130	130-135	135-140	140-150	150-160	
2835A18-35H10-XX-XX		QD	QE	QF	QG	Q4	Q5	
		120-125	125-130	130-135	135-140	140-150	150-160	
2835A18-40H10-XX-XX		QE	QF	QG	Q4	Q5	Q6	
		125-130	130-135	135-140	140-150	150-160	160-170	
2835A18-50H10-XX-XX		QE	QF	QG	Q4	Q5	Q6	
		125-130	130-135	135-140	140-150	150-160	160-170	
2835A18-57H10-XX-XX		QE	QF	QG	Q4	Q5	Q6	
		125-130	130-135	135-140	140-150	150-160	160-170	
2835A18-60H10-XX-XX	QE	QF	QG	Q4	Q5	Q6		
	125-130	130-135	135-140	140-150	150-160	160-170		
2835A18-65H10-XX-XX	QE	QF	QG	Q4	Q5	Q6		
	125-130	130-135	135-140	140-150	150-160	160-170		

(2) Forward Voltage (Tj=25°C)

Rank	Condition	Min.	Max.	Unit
G4	60mA	17.0	17.5	V
G5		17.5	18.0	
G6		18.0	18.5	
G7		18.5	19.0	
G8		19.0	19.5	
G9		19.5	20.0	

Notes:

1. 10% tolerance for luminous intensity may be caused by measurement inaccuracy.
2. Measurement Uncertainty of the Forward Voltage : $\pm 0.1V$

(3) Chromaticity Bins

Part Number	2835A18-27H10-XX-XX			CCT	2700K
Bin Code	Color Coordinates(X,Y)				
SA0	X	0.4658	0.4578	0.4502	0.4576
	Y	0.4181	0.4162	0.4022	0.4040
SAA	X	0.4742	0.4657	0.4578	0.4658
	Y	0.4261	0.4241	0.4101	0.4120
SAB	X	0.4657	0.4577	0.4503	0.4578
	Y	0.4241	0.4223	0.4083	0.4101
SAC	X	0.4578	0.4503	0.443	0.4499
	Y	0.4101	0.4083	0.3944	0.3961
SAD	X	0.4658	0.4578	0.4499	0.4574
	Y	0.4120	0.4101	0.3961	0.3978

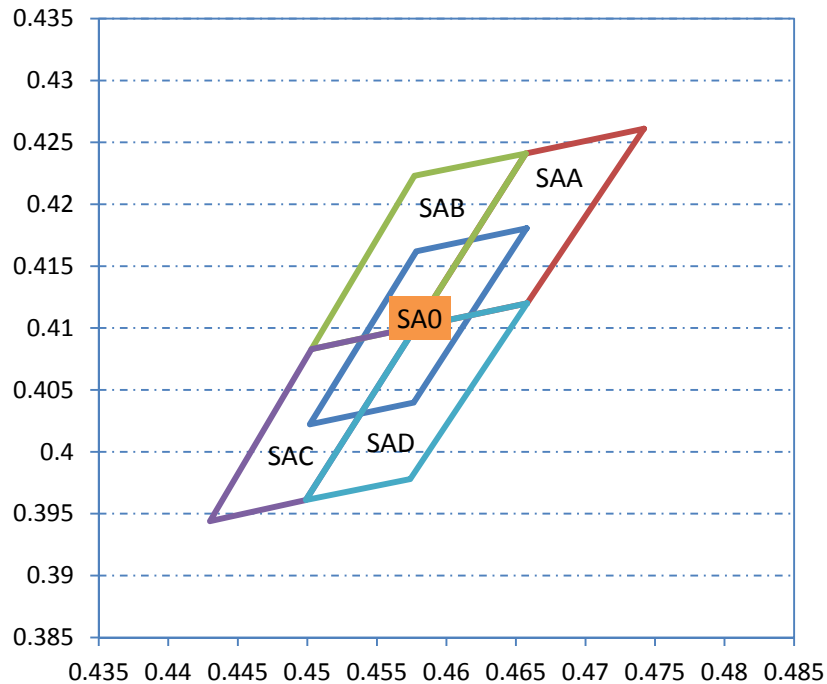

(3) Chromaticity Bins

Part Number	2835A18-30H10-XX-XX			CCT	3000K
Bin Code	Color Coordinates(X,Y)				
SB0	X	0.4410	0.4325	0.4270	0.4350
	Y	0.4107	0.4077	0.3954	0.3983
SBA	X	0.4509	0.4394	0.4338	0.4446
	Y	0.4191	0.4150	0.4030	0.4069
SBB	X	0.4394	0.4291	0.4240	0.4338
	Y	0.4150	0.4113	0.3995	0.4030
SBC	X	0.4338	0.4240	0.4189	0.4282
	Y	0.4030	0.3995	0.3877	0.391
SBD	X	0.4446	0.4338	0.4282	0.4384
	Y	0.4069	0.4030	0.391	0.3944

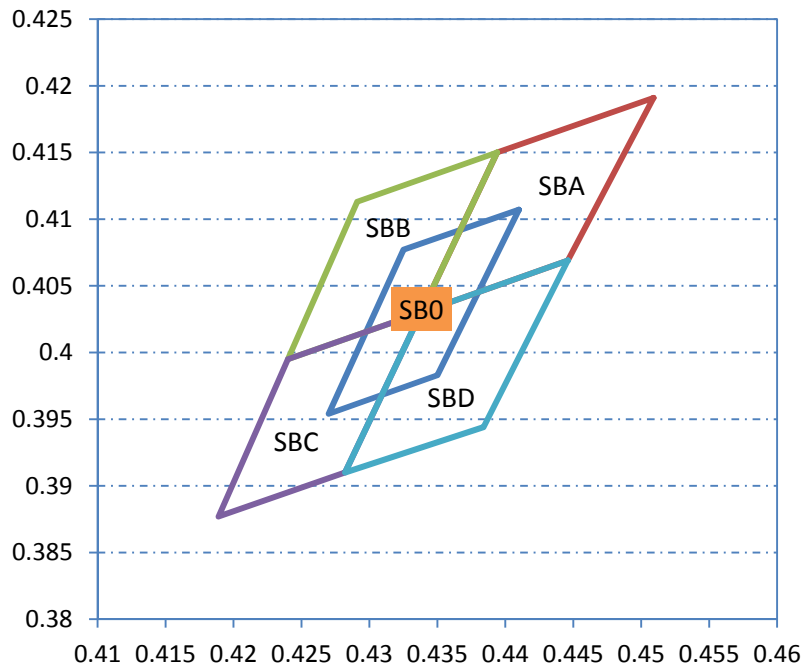

(3) Chromaticity Bins

Part Number	2835A18-35H10-XX-XX			CCT	3500K
Bin Code	Color Coordinates(X,Y)				
SC0	X	0.4143	0.4058	0.4009	0.4088
	Y	0.4010	0.3968	0.3827	0.3866
SCA	X	0.4216	0.4125	0.4073	0.4158
	Y	0.4104	0.4059	0.3917	0.3959
SCB	X	0.4125	0.4042	0.3994	0.4073
	Y	0.4059	0.4018	0.3878	0.3917
SCC	X	0.4073	0.3994	0.3947	0.4021
	Y	0.3917	0.3878	0.3738	0.3775
SCD	X	0.4158	0.4073	0.4021	0.41
	Y	0.3959	0.3917	0.3775	0.3814

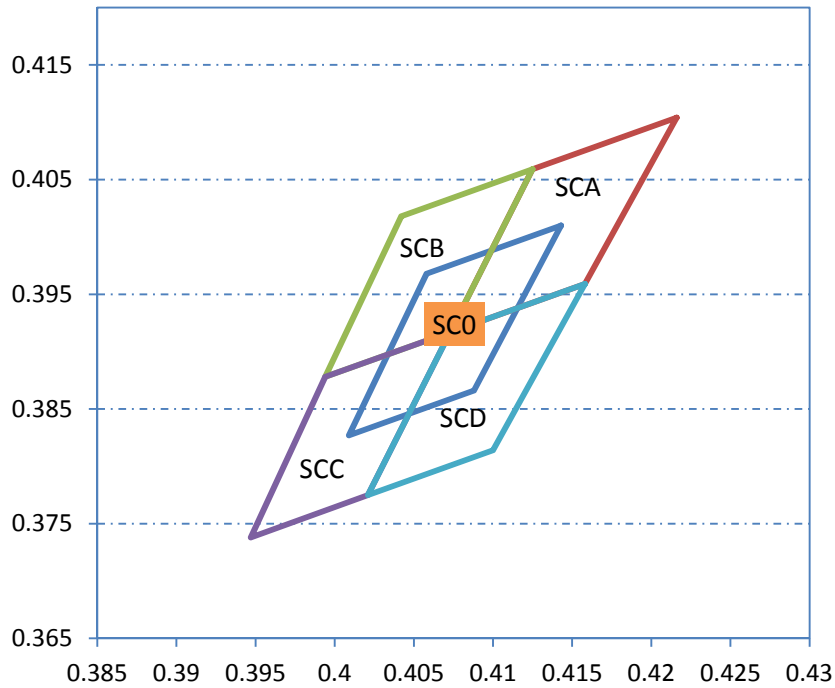

(3) Chromaticity Bins

Part Number	2835A18-40H10-XX-XX			CCT	4000K
Bin Code	Color Coordinates(X,Y)				
SD0	X	0.3890	0.3783	0.3753	0.3853
	Y	0.3897	0.3830	0.3701	0.3764
SDA	X	0.3971	0.3852	0.3818	0.3929
	Y	0.4003	0.3928	0.3797	0.3867
SDB	X	0.3852	0.3747	0.3719	0.3818
	Y	0.3928	0.3862	0.3735	0.3797
SDC	X	0.3818	0.3719	0.3692	0.3784
	Y	0.3797	0.3735	0.3608	0.3666
SDD	X	0.3929	0.3818	0.3784	0.3888
	Y	0.3867	0.3797	0.3666	0.3731

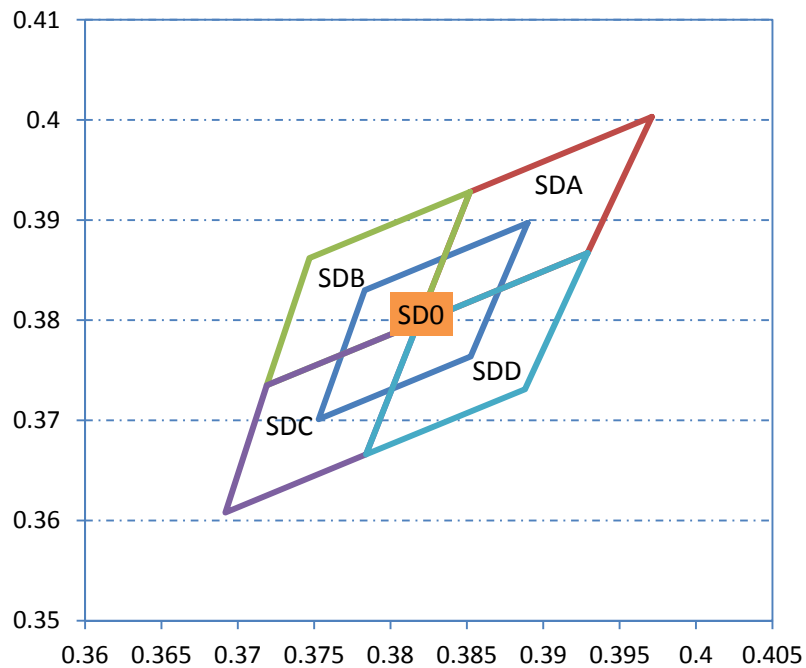

(3) Chromaticity Bins

Part Number	2835A18-50H10-XX-XX			CCT	5000K
Bin Code	Color Coordinates(X,Y)				
SF0	X	0.3498	0.3406	0.3402	0.3489
	Y	0.3637	0.3562	0.3473	0.3545
SFA	X	0.3546	0.3454	0.3447	0.3534
	Y	0.3719	0.3643	0.3553	0.3625
SFB	X	0.3454	0.3366	0.3364	0.3447
	Y	0.3643	0.3571	0.3485	0.3553
SFC	X	0.3447	0.3364	0.3361	0.344
	Y	0.3553	0.3485	0.3398	0.3463
SFD	X	0.3534	0.3447	0.344	0.3523
	Y	0.3625	0.3553	0.3463	0.3531

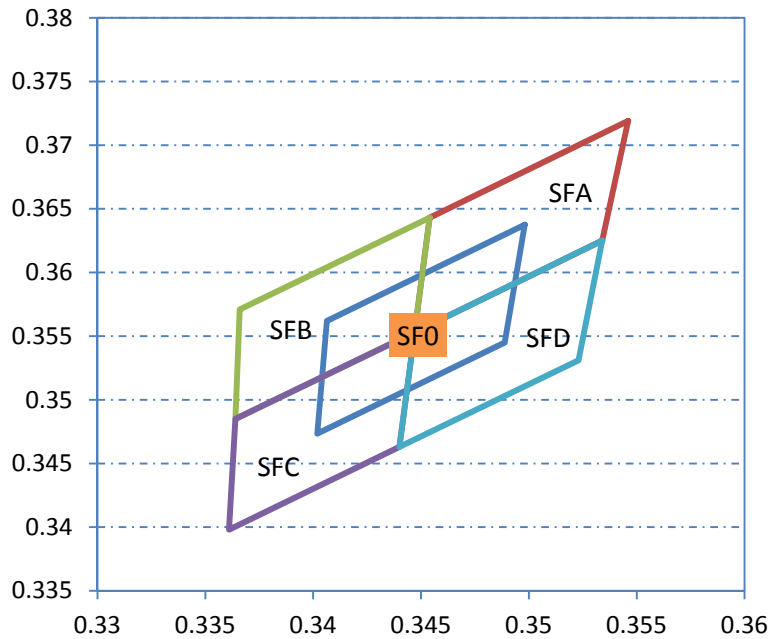

(3) Chromaticity Bins

Part Number	2835A18-57H10-XX-XX				CCT	5700K
Bin Code	Color Coordinates(X,Y)					
SG0	X	0.3323	0.3251	0.3255	0.3323	0.3323
	Y	0.3486	0.3425	0.3352	0.3409	0.3486
SGA	X	0.3366	0.3285	0.3287	0.3364	0.3366
	Y	0.3561	0.3493	0.3417	0.3482	0.3561
SGB	X	0.3285	0.3214	0.3219	0.3287	0.3285
	Y	0.3493	0.3433	0.3360	0.3417	0.3493
SGC	X	0.3287	0.3219	0.3224	0.3289	0.3287
	Y	0.3417	0.3360	0.3286	0.3341	0.3417
SGD	X	0.3364	0.3287	0.3289	0.3361	0.3364
	Y	0.3482	0.3417	0.3341	0.3403	0.3482

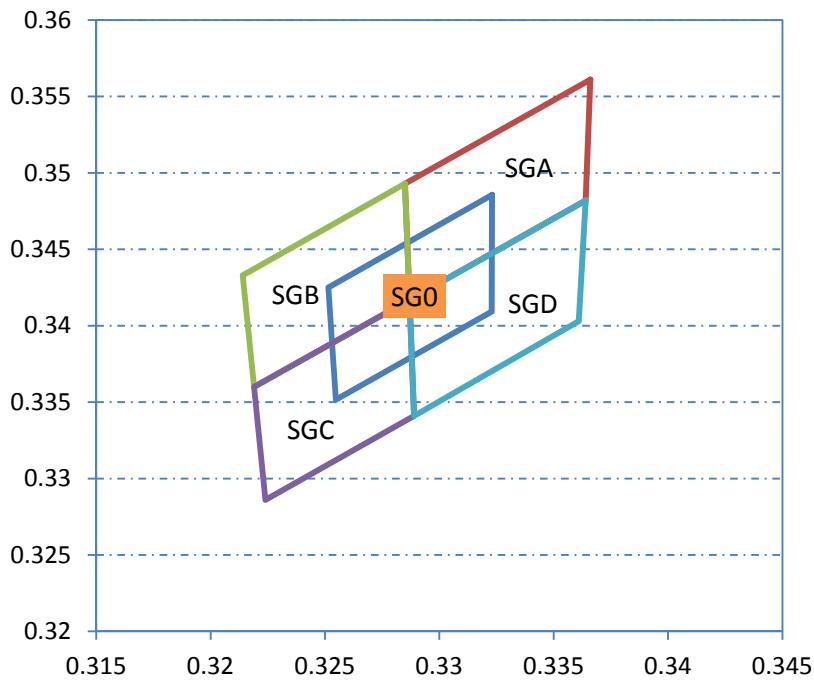

(3) Chromaticity Bins

Part Number	2835A18-60H10-XX-XX		CCT	6000K	
Bin Code	Color Coordinates(X,Y)				
SK0	X	0.3251	0.3185	0.3191	0.3255
	Y	0.3425	0.3365	0.3298	0.3355
SKA	X	0.3285	0.3214	0.3219	0.3287
	Y	0.3493	0.3433	0.3360	0.3417
SKB	X	0.3214	0.3151	0.3159	0.3219
	Y	0.3433	0.3376	0.3306	0.3360
SKC	X	0.3219	0.3159	0.3167	0.3224
	Y	0.3360	0.3306	0.3234	0.3286
SKD	X	0.3287	0.3219	0.3224	0.3289
	Y	0.3417	0.3360	0.3286	0.3341

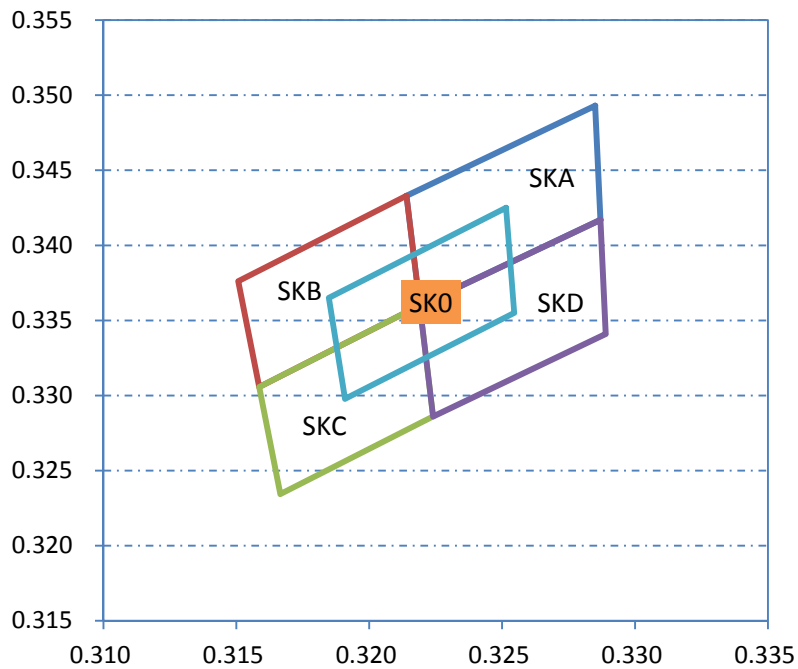

(3) Chromaticity Bins

Part Number	2835A18-65H10-XX-XX			CCT	6500K
Bin Code	Color Coordinates(X,Y)				
SH0	X	0.3154	0.3086	0.3096	0.3161
	Y	0.3345	0.3277	0.3219	0.3284
SHA	X	0.3179	0.3113	0.3123	0.3187
	Y	0.3420	0.3353	0.3280	0.3344
SHB	X	0.3113	0.3054	0.3067	0.3123
	Y	0.3353	0.3295	0.3224	0.3280
SHC	X	0.3123	0.3067	0.3080	0.3133
	Y	0.3280	0.3224	0.3153	0.3207
SHD	X	0.3187	0.3123	0.3133	0.3193
	Y	0.3344	0.3280	0.3207	0.3267

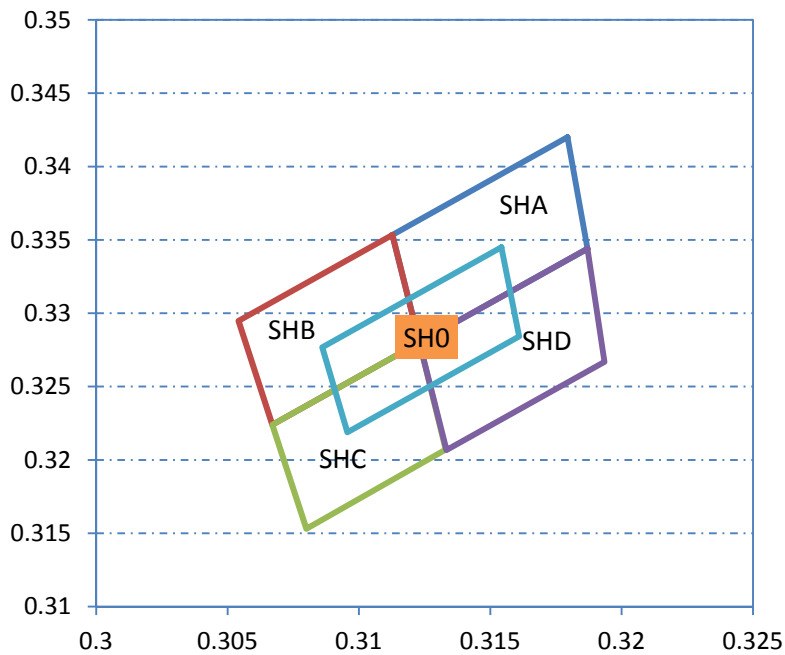

REFLOW SOLDERING CHARACTERISTICS

For Reflow Process:

Preheating : 140°C~160°C±5°C, within 2 minutes.

Operation heating : 260°C(Max.) within 10 seconds.(Max)

Gradual Cooling (Avoid quenching).

Lead solder		Lead-free solder	
Pre-heat	120-150°C	Pre-heat	150-200°C
Pre-heat time	120 sec.Max.	Pre-heat time	120 sec.Max.
Peak Temperature	240°C Max.	Peak Temperature	260°C Max.
Soldering time condition	10 sec.Max.	Soldering time condition	10 sec.Max.

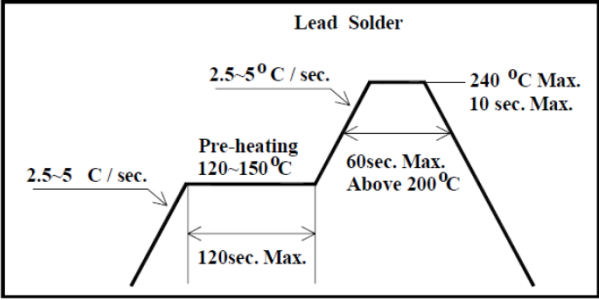
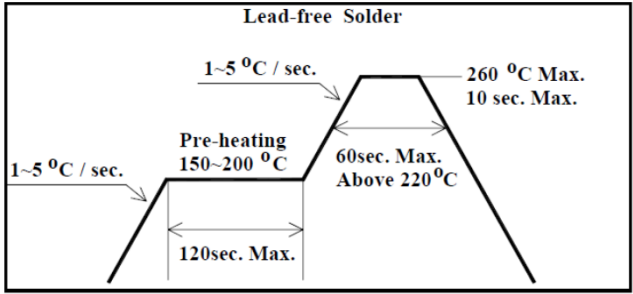
 <p>Lead Solder</p> <p>2.5~5 °C / sec. → 240 °C Max. 10 sec. Max.</p> <p>Pre-heating 120~150°C 60sec. Max. Above 200°C</p> <p>2.5~5 C / sec. → 120sec. Max.</p>	 <p>Lead-free Solder</p> <p>1~5 °C / sec. → 260 °C Max. 10 sec. Max.</p> <p>Pre-heating 150~200 °C 60sec. Max. Above 220°C</p> <p>1~5 °C / sec. → 120sec. Max.</p>
--	--

Notes:

The encapsulated material of the LEDs is silicone . Therefore the LEDs have a soft surface on the top of package. The pressure to the top surface will be influence to the reliability of the LEDs. Precautions should be taken to avoid the strong pressure on the encapsulated part. So when using the picking up nozzle, the pressure on the silicone resin should be proper.

TAPE AND REEL

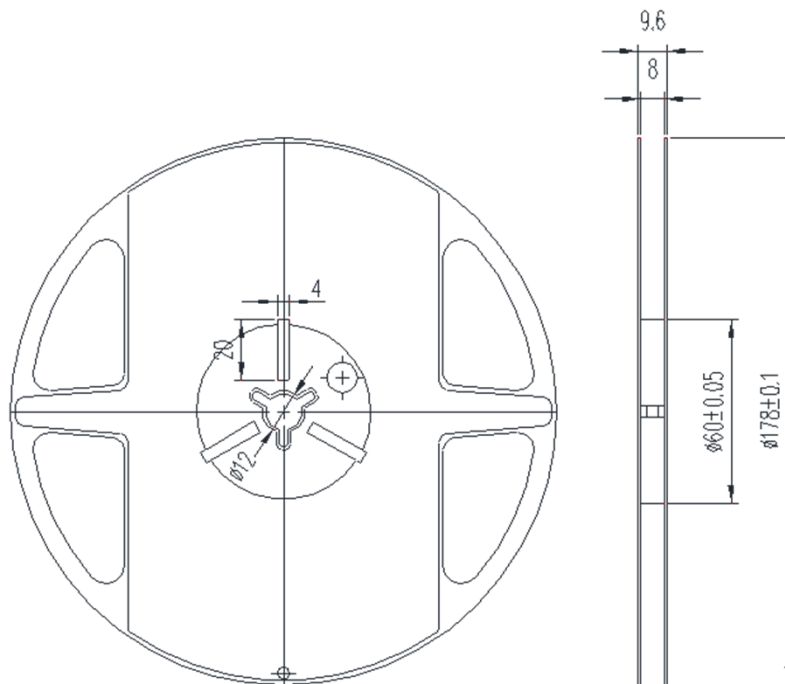
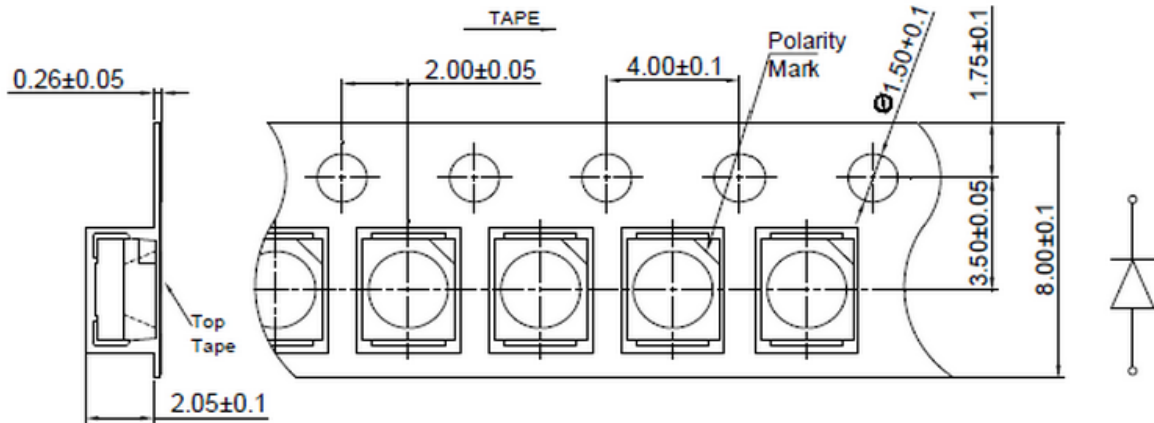

Note: The tolerances unless mentioned is ± 0.1 mm, Unit=mm

Notes:

- (1) Quantity : 4000pcs/Reel
- (2) Cumulative Tolerance : Cumulative Tolerance/10 pitches to be ± 0.2 mm
- (3) Adhesion Strength of Cover Tape : Adhesion strength to be 0.1-0.7N when the cover tape is turned off from the carrier tape at the angle of 10° to the carrier tape
- (4) Package : P/N, Manufacturing data Code No. and quantity to be indicated on a damp proof Package.

PACKAGING

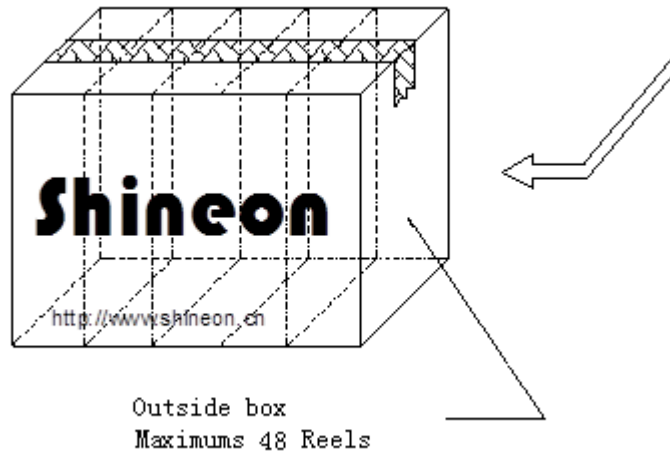
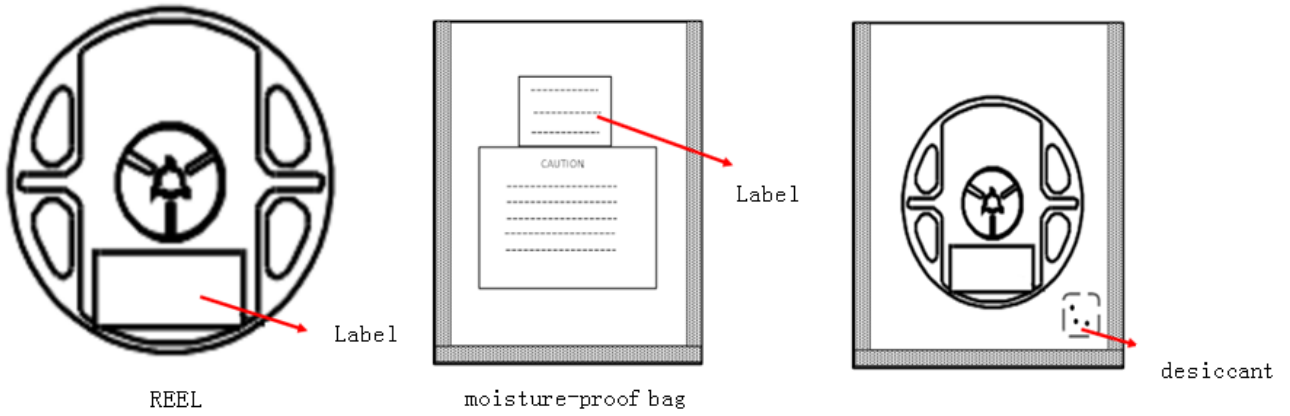

Reliability Test Items

Test Items	Test Duration	Number of Damaged
Steady State Operating Life of High Temperature (HTOL) $T_s=85^{\circ}\text{C}$, $I_F=\text{Max}$	1000hrs	0/20
Steady State Operating Life of Low Temperature (LTOL) $T_a=-40^{\circ}\text{C}$, $I_F=\text{Max}$	1000hrs	0/20
Pulse Wet Operating Life of High Temperature (PWHTOL) $60^{\circ}\text{C}/90\%\text{RH}$, $I_F30\text{mins ON}/30\text{min OFF}$	500hrs	0/20
High Temperature Storage (HTS) 100°C	1000hrs	0/20
Low Temperature Storage (LTS) -40°C	1000hrs	0/20
Thermal Shock (TS) $-45^{\circ}\text{C}\sim 125^{\circ}\text{C}$ 30min dwell 20sec transfer	200cycles	0/20
Solder Resistance (SR) 265°C , 3X MSL	5sec	0/20
Solder Ability (SA) 245°C 5sec, 95% coverage	5sec	0/11
Mechanical Shock (MS) 1500G 0.5msec pulse shock	Each 6 axis	0/6
Random Vibration (RV) 6G RMS, 10-2000Hz, 10min	Per axis	0/6
Variable Vibration Frequency (VVF) 10-2000-10Hz, log or linear sweep rate, 20G for 1 min, 1.5mm each apply 3x per axis over	6hrs	0/6
Salt Spread (SS) 35°C , 30g/m ² /day	48hrs	0/11

Item	Symbol	Test Condition	Criteria for Judgment	
			Min.	Max.
Forward	V_f	$I_F=\text{Typical Current}$		U.S.L x1.1
Luminous Flux	I_m	$I_F=\text{Typical Current}$	L.S.L x0.7	
CCX&CCY	x,y	$I_F=\text{Typical Current}$		Shift<0.02

PRECAUTION FOR USE

- (1) This device should not be used in any type of fluid such as water, oil, organic solvent, etc. When washing is required, IPA should be used.
- (2) When the LEDs are illuminating, operating current should be decided after considering the ambient maximum temperature.
- (3) LEDs must be stored to maintain a clean atmosphere. If the LEDs are stored for 3 months or more after being shipped from ShineOn, a sealed container with a nitrogen atmosphere should be used for storage.
- (4) The LEDs must be used within seven days after opening the moisture proof packing. Repack unused Products with anti-moisture packing, fold to close any opening and then store in a dry place.
- (5) The appearance and specifications of the product may be modified for improvement without notice.
- (6) This LED is sensitive to the static electricity and surge. It is recommended to use a wrist Band or anti-electrostatic glove when handling the LEDs.
- (7) On manual soldering, a solder tip must be needed as grounded for usage. If over voltage which exceeds the absolute maximum rating is applied to LEDs, it will cause damage LEDs and result in destruction. Damaged LEDs will show some unusual characteristics such as leak current remarkably increase, turn-on voltage becomes lower and the LEDs get unlighted at low current.