



PC35A31 V0 Preliminary
Product Specification

Approval Sheet

PC35A31 V0

Product Specification



Product	Yellow SMD LED
Part Number	PC35A31 V0
Issue Date	2018/07/27



■ Feature

- ✓ Yellow SMD LED (L x W x H) of 3.5 x 2.8 x 1.9 mm
- ✓ AEC-Q101 Rev. D and IEC 60810 qualification
- ✓ Dice Technology : AlGaInP
- ✓ Qualified according to JEDEC moisture sensitivity Level 2
- ✓ Environmental friendly ; RoHS compliance
- ✓ ESD protection
- ✓ Packing : 2,000 or 1,000 pcs/reel

■ Applications

- ✓ Optical Indicator
- ✓ Automotive Interior lighting
- ✓ Backlighting
- ✓ Outdoor displays
- ✓ Signal and symbol Luminary
- ✓ Dash board lighting

Outline Dimension

PC35A31 V0
Product Specification

Package Dimension

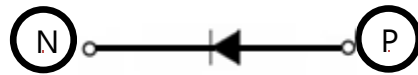
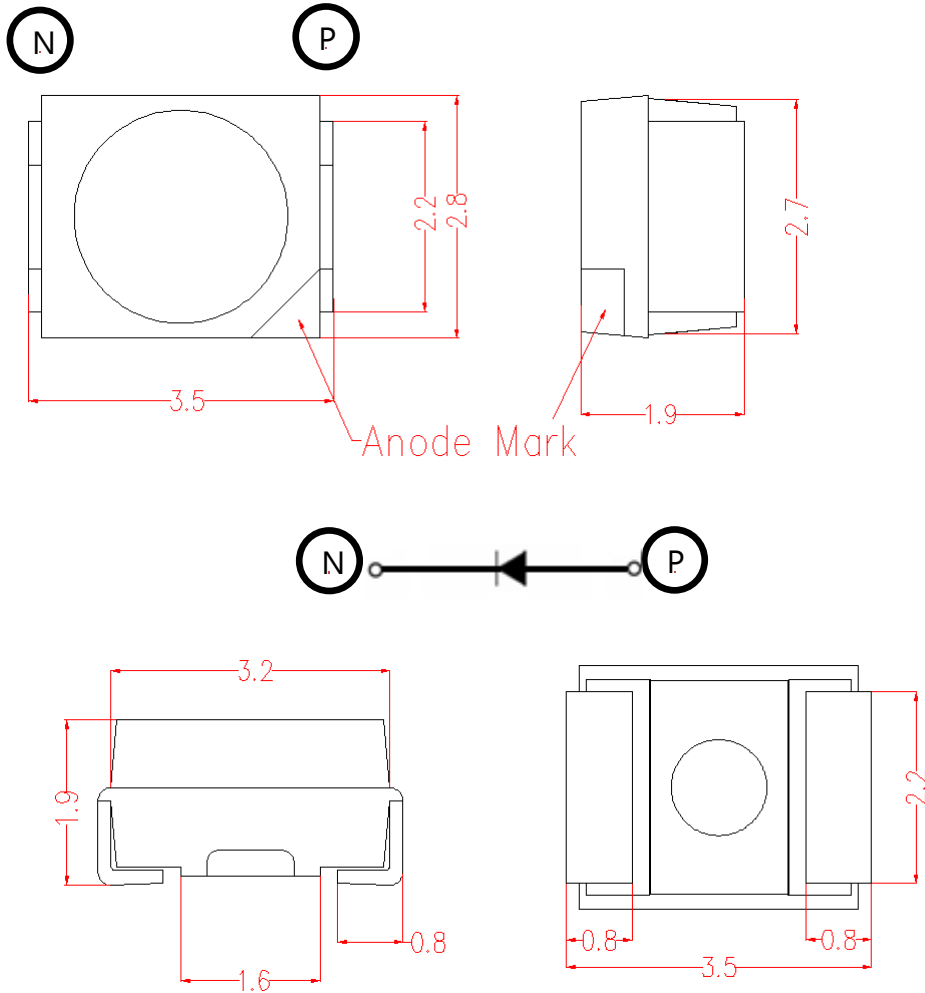

Unit: mm, Tolerance: $\pm 0.1\text{mm}$

Recommended Soldering Pad

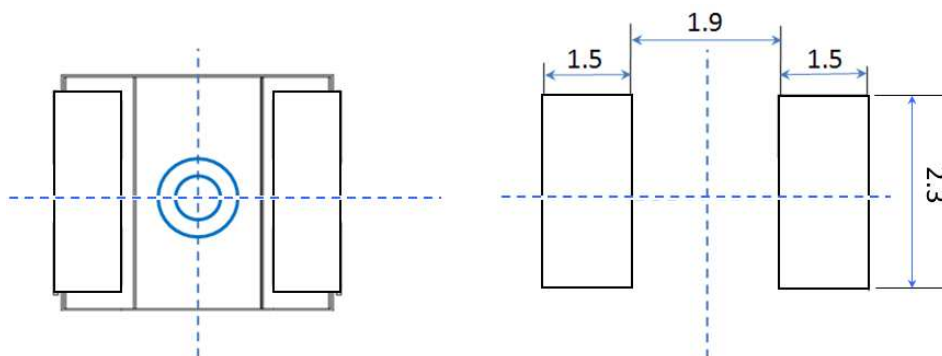

Performance

PC35A31 V0
 Product Specification

■ Electro-Optical Characteristics (Ta=25°C)

Parameter	Symbol	Condition	Min.	Typ.	Max.	Unit
Forward Voltage	V_F	$I_F = 20 \text{ mA}$	1.8	2.15	2.4	V
Luminous Flux	I_v		650	850	1000	mcd
Dominant Wavelength	nm		585.5	590	595	nm
View Angle	θ		120			deg
Thermal Resistance	R_{th}		240			°C/W

* The Forward Voltage tolerance is $\pm 0.05\text{V}$

* The luminous intensity tolerance is $\pm 8\%$

* The Wavelength tolerance is $\pm 0.5\text{nm}$

■ Absolute Maximum Ratings

Parameter	Symbol	value	Unit
DC Forward Current ⁽¹⁾	I_F	30	mA
Power Dissipation	P_D	0.04	W
Pulse Forward Current ⁽²⁾	I_{FP}	50	mA
Storage Temperature	T_{stg}	-40 ~ +105	°C
Operating Temperature	T_{opr}	-40 ~ +105	°C
Junction Temperature	T_j	125	°C
ESD (HBM)	ESD_{HBM}	2000	V
Assembly Temperature	T_{sld}	260	°C

(1) Proper current rating must be observed to maintain junction temperature below maximum at all time

(2) IFP Condition: Duty 5/1000, Pulse within 10 us

Binning

PC35A31 V0

Product Specification

Bin code Definition

V _F Rank	Luminous Flux Rank	Wd Rank
A	V1	A1000

Forward Voltage Definition Group

V _F Rank	Condition	Min. (V)	Max. (V)
A	I _F = 20 mA T _j =25°C	1.80	2.00
B		2.00	2.20
C		2.20	2.40

Luminous Intensity Definition Group

Luminous Intensity Rank	Condition	Min. I _v (mcd)	Max. I _v (mcd)
V1	I _F = 20 mA T _j =25°C	650	750
V2		750	800
V3		800	850
V4		850	900
V5		900	1000

CIE Rank

Wd Rank	Condition	Min. Wd (nm)	Max. Wd (nm)
A1000	I _F = 20 mA T _j =25°C	585.5	588.5
A2000		588.5	592.5
A3000		592.5	595.0

* The Forward Voltage tolerance is ±0.05V

* The luminous intensity tolerance is ± 8%

* The Wavelength tolerance is ±0.5nm

Characteristics

PC35A31 V0
Product Specification

Spectrum

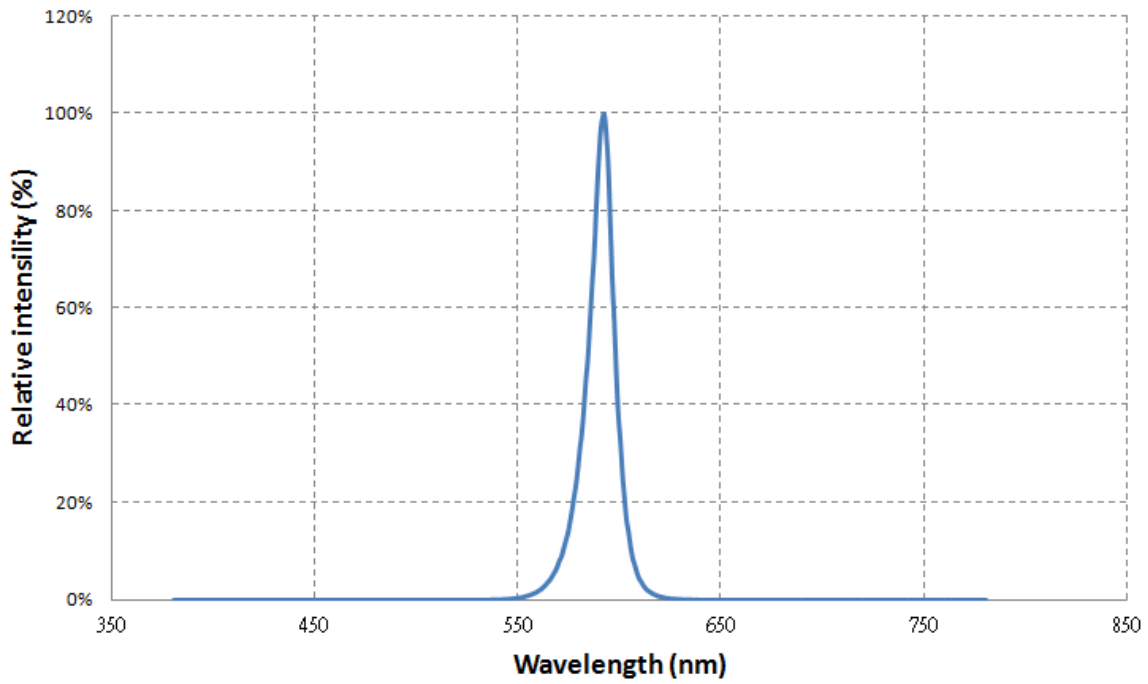

Radiation Pattern

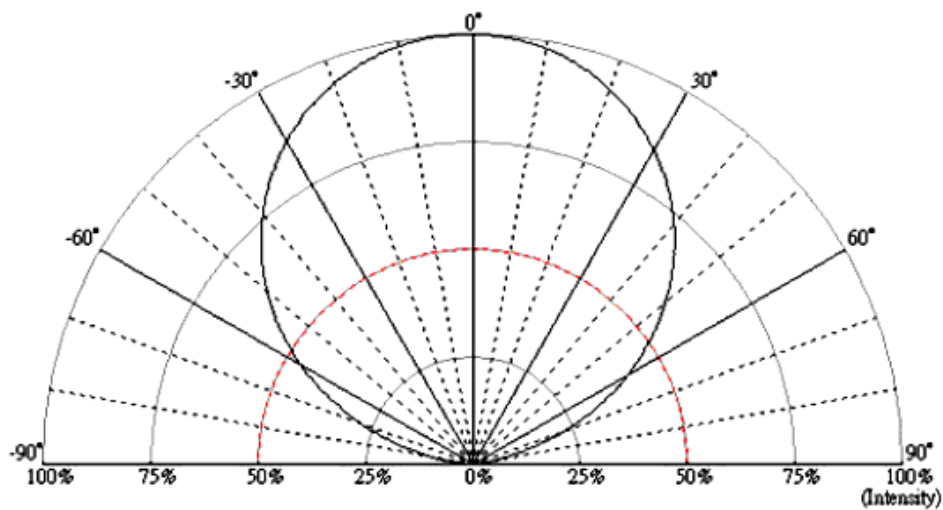

■ **Forward Voltage vs. Forward Current, Ta=25°C**

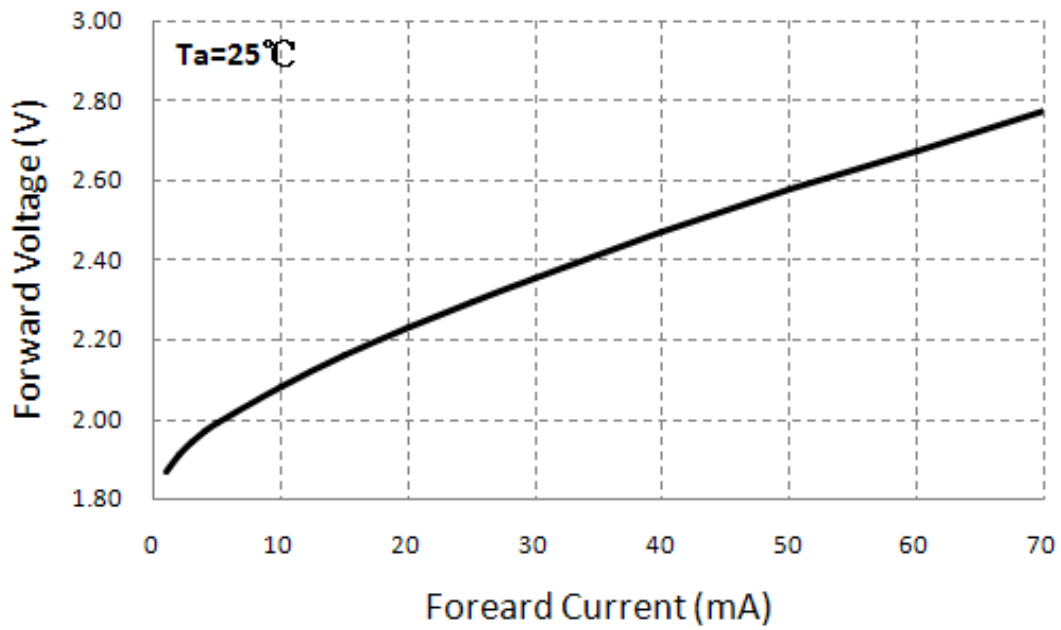

■ **Forward Current vs. Relative Luminous Intensity, Ta=25°C**

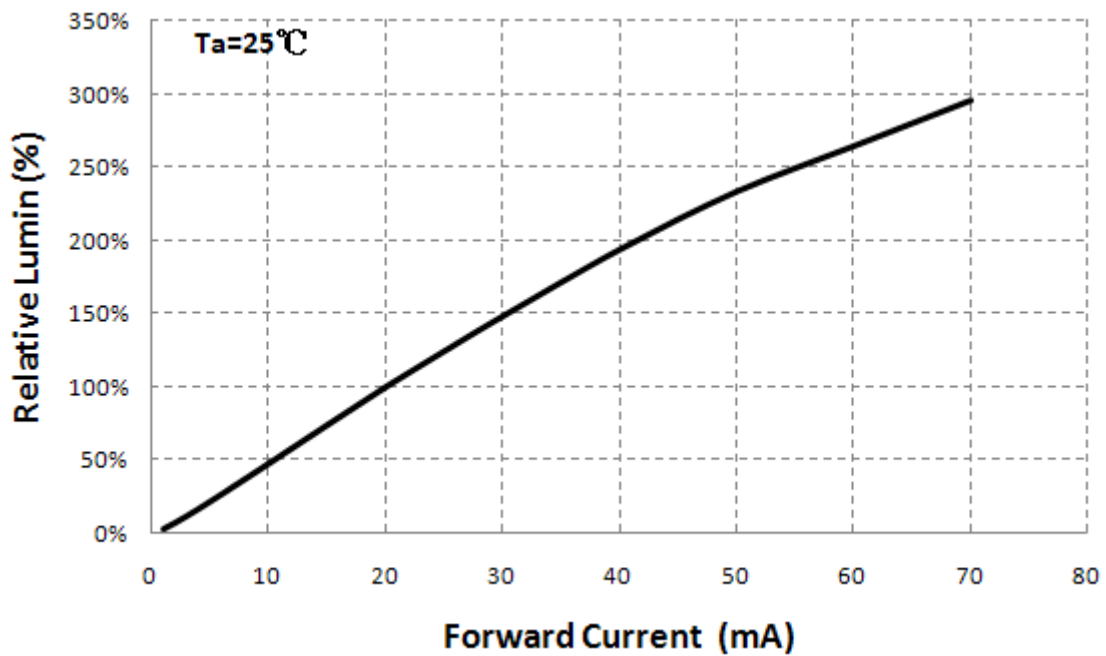

■ **Forward Current vs. Relative CIE coordinate, Ta=25°C**

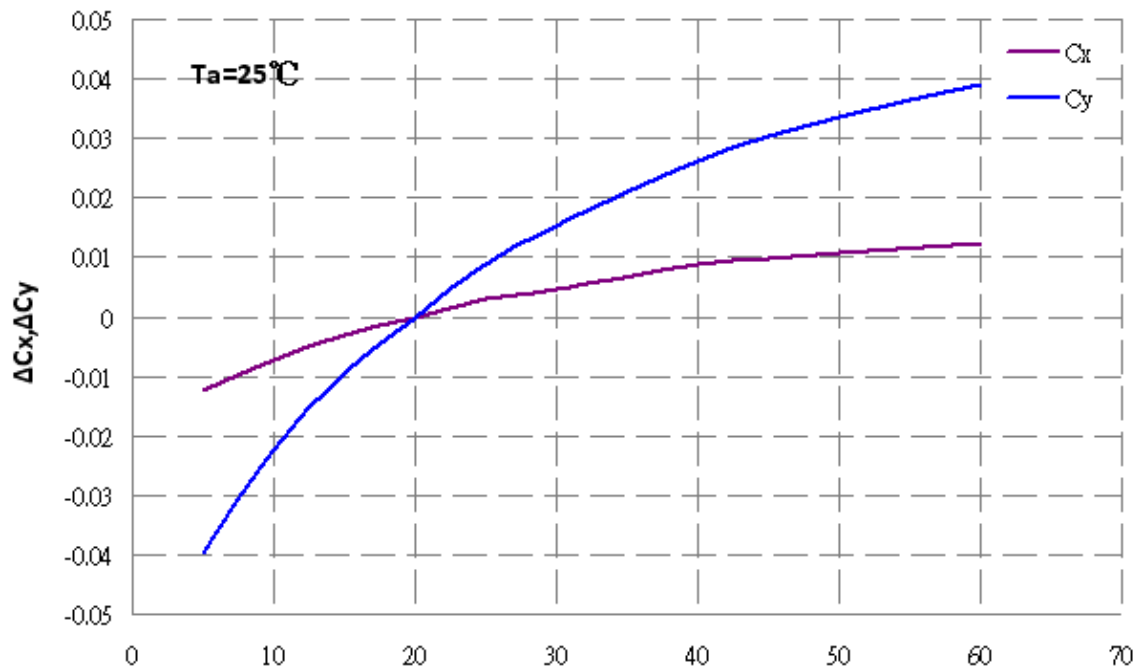

■ **Relative Forward Voltage vs. Ambient Temperature**

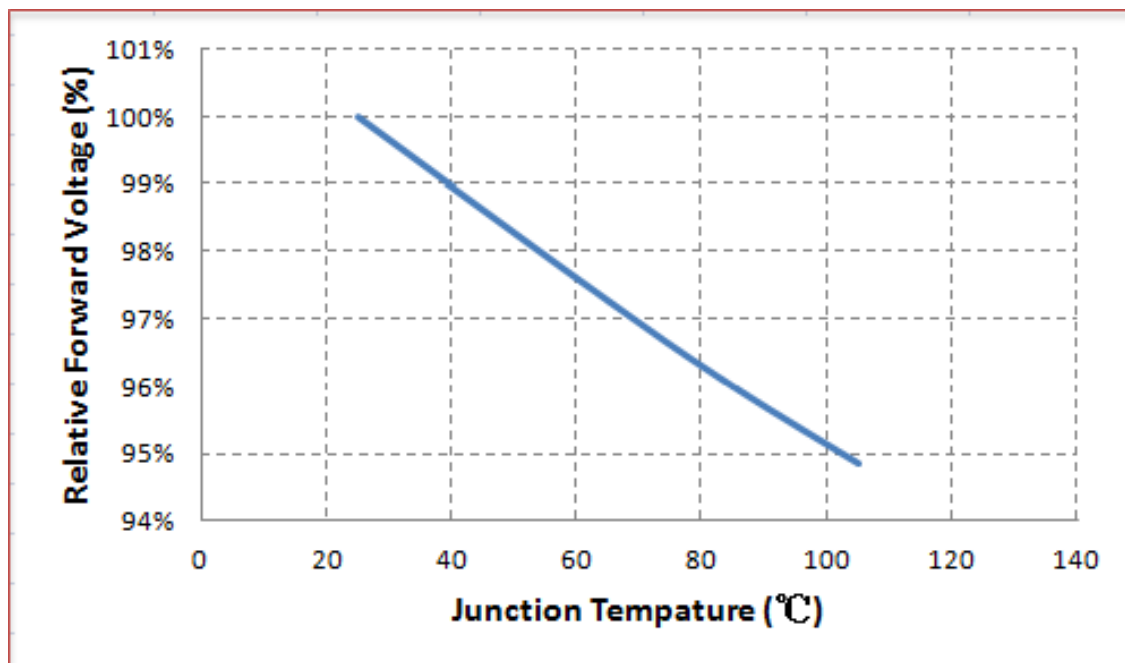

■ **Relative Luminous Intensity vs. Ambient Temperature**

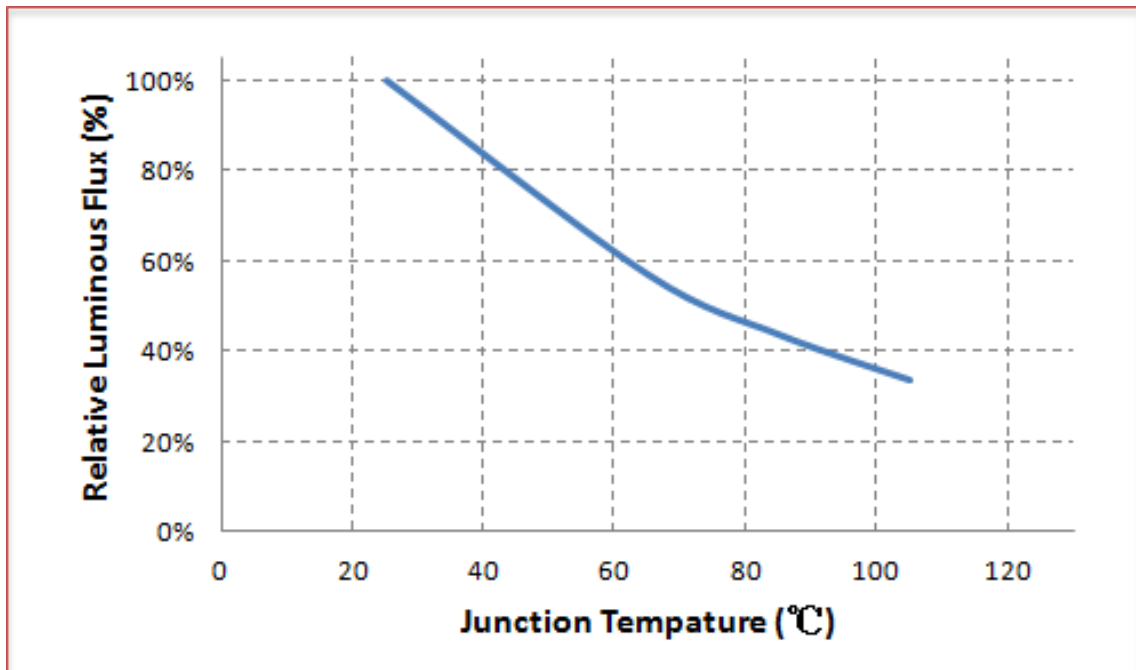

■ **Relative Dominant Wavelength vs. Ambient Temperature**

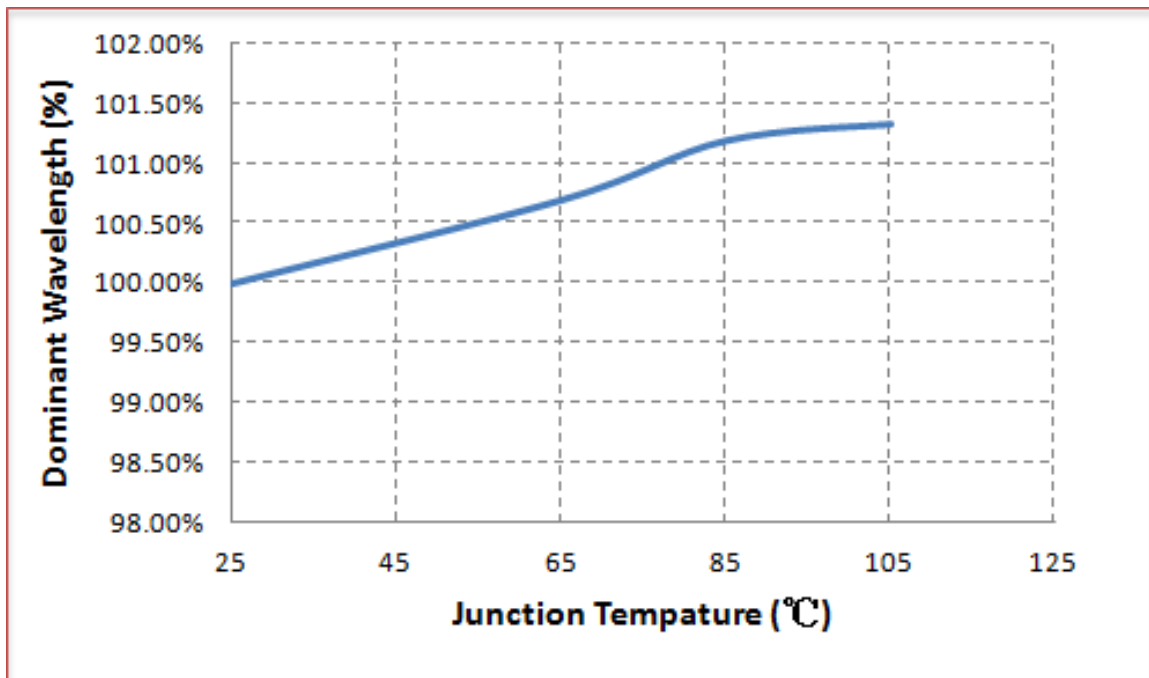

Reliability

PC35A31 V0
 Product Specification

Reliability test

	Item	Reference Standard	Condition	Time/Cycle
1	Thermal shock	JESD22-A106	-40°C to 100 °C, 20 mins dwell, 5 min transfer time	1000 Cycles
2	Power and Temperature Cycle	AEC-Q101 Rev. D	-40 °C~ 85 °C, IF=30mA, Dwell/transfer time = 10 mins, 20 mins 1,000 cycles , on/off 15,000 cycles	15,000 cycles
3	MSL Level 2	J-STD-020	85°C / 60% RH	168 hours
4	High Temperature Storage	JESD22-A103	TA=105°C, 1000h	1000 hours
5	Low Temperature Storage	JESD22-A119	TA=-40°C, 1000h	1000 hours
6	High Temperature Operating Life	AEC-Q101 Rev. D	TA=105°C, IF=30mA	1000 hours
7	Low Temperature Operating Life	JESD22-A108	TA=-40°C, IF=30mA	1000 hours
8	Temperature Humidity Operating Life	AEC-Q101 Rev. D	85°C, RH=85%, 1000h, IF=30mA	1000 hours
9	Electrostatic Discharges	AEC-Q101 Rev. D	HBM 2 KV, 1.5KΩ, 100pF, 3 pulses, alternately positive or negative	

Judgment Criteria

Item	Symbol	Test Condition	Judgment Criteria
Forward Voltage	Vf	20mA	$\Delta V_f < 10\%$
Luminous Flux	Iv	20mA	$\Delta I_v < 20\%$
Delta CIE	CIE-x ,CIE-y	20mA	$\Delta x,y < 0.01$

Packing

PC35A31 V0
 Product Specification

Label

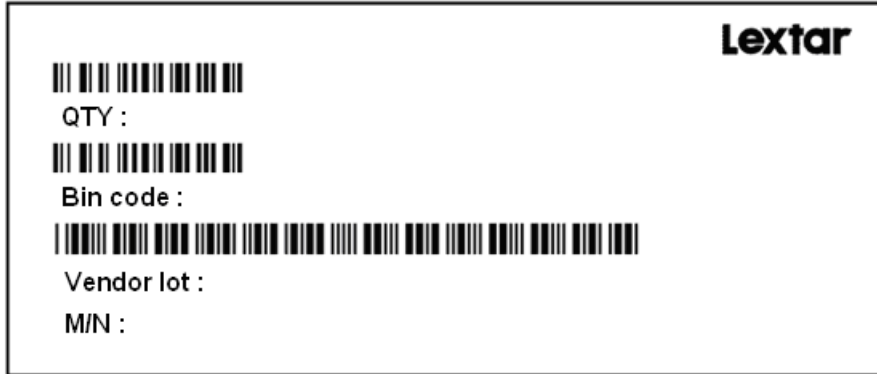

Carrier Taping

Dimensions. (Unit: mm)

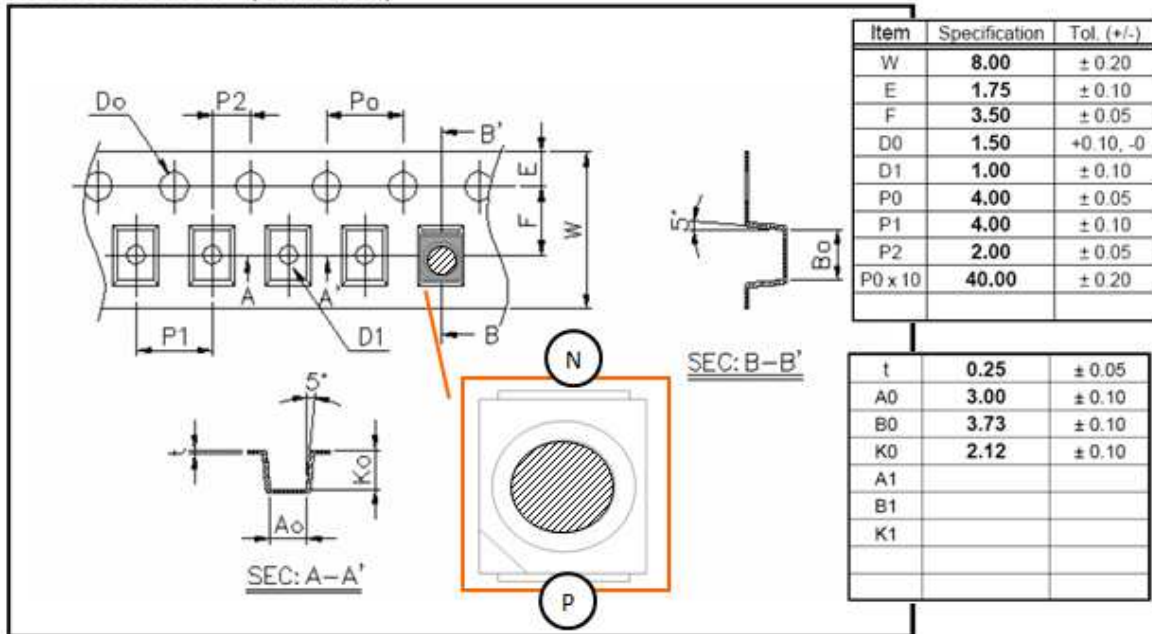

(Unit : mm)

■ **Shield Bag Taping**

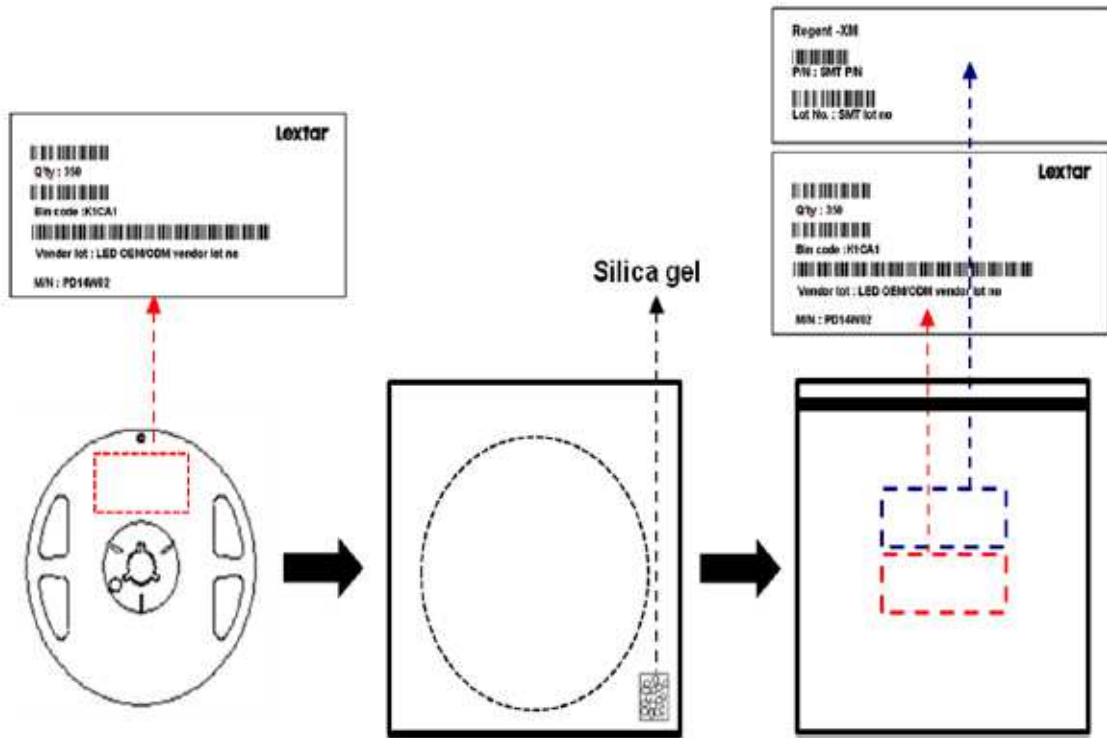

■ **Packing Box**

Type	Large Box		Medium Box		Small Box	
Dimension	541X511X276mm		385X303X260mm		283X235x70mm	
Maximum Reels	7"X12mm Reel	64/R	7"X12mm Reel	21/R	7"X12mm Reel	4/R
Minimum Reels	7"X12mm Reel	32/R	7"X12mm Reel	9/R	7"X12mm Reel	1/R

■ **Small Box**

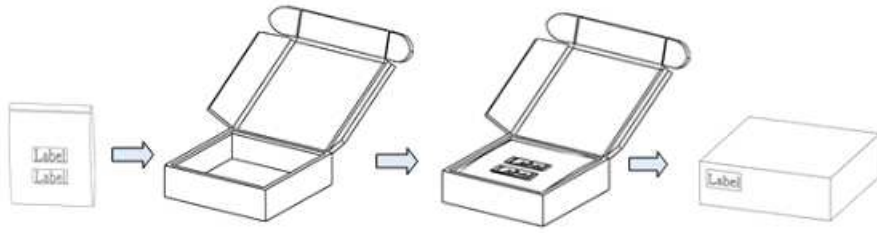

■ **Medium Box**

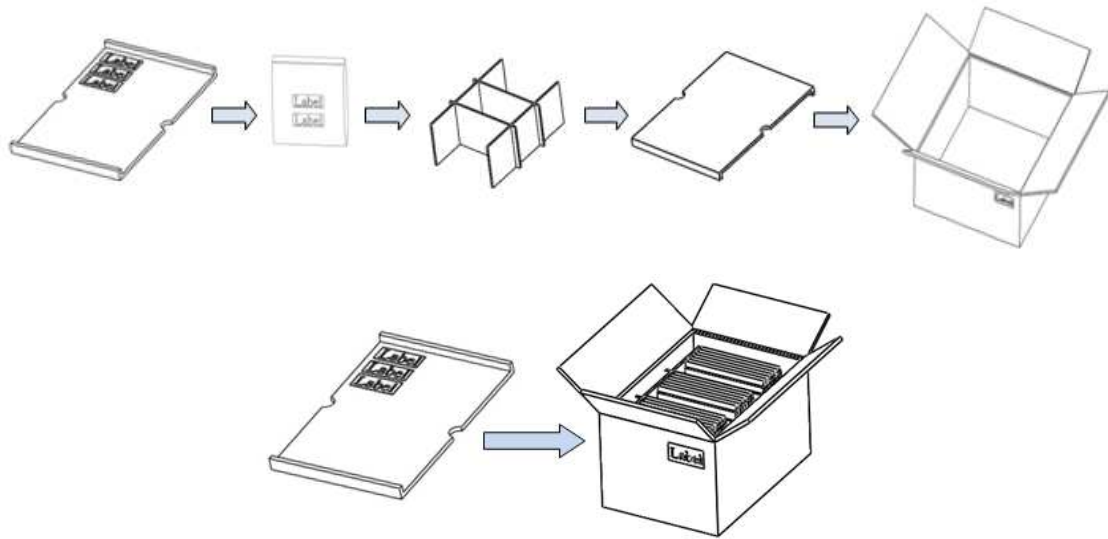

■ **Large Box**

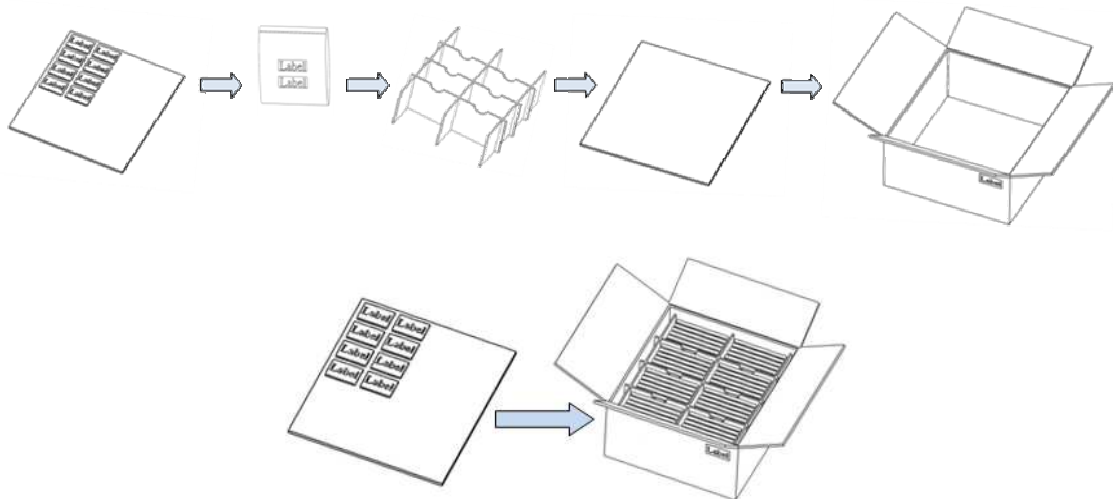

Precautions

PC35N33 V0

Product Specification

■ Safety Precautions

- The LED light output is too strong for human eyes without shield. Prevent eye contact directly more than seconds.
- Ensure operating under maximum rating.

■ Storage

- Before opening the package, the LEDs should be kept at 40°C, 90% RH environment or less, and should be used within one year.
- After opening the package bag,
The LEDs should be kept at 30°C, 60% RH environment or less.
The LEDs should be soldered within 12 months (1 year).
If unused LEDs remain, they should be stored in moisture proof packages, such as sealed containers with packages of moisture absorbent material (silica gel).
- If the package is over storage time, the LEDs should be pre-bake 65 ± 5 °C / 12 hrs before use. (One time only).

■ Soldering Notice and Conditions

- When soldering LEDs,
- Do not solder/reflow the same LED over two times.
- Reflow temperature profile as below: (lead-free solder)

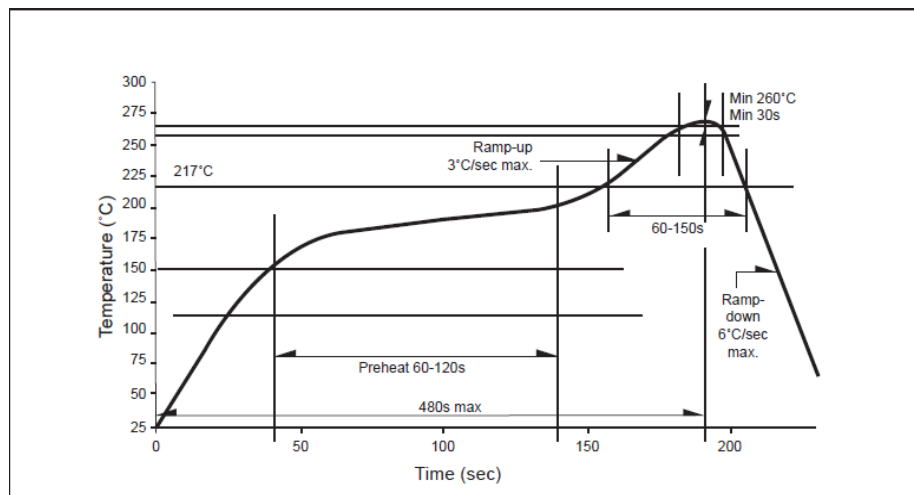

Classification Reflow Profile (JEDEC J-STD-020D)

- When soldering, don't put stress on the LEDs
- After LEDs have been soldered, strongly recommend not to repair to keep the LEDs performance.

■ Static Electricity

- LED package is extremely sensitive to static electricity. It's recommended that anti-electrostatic glove and wrist band is necessary when handling the LEDs. All devices are also be grounded properly as well.
- Protection devices design should be considered in the LED driving circuit.

■ Cleaning

- If washing is required, recommend to use alcohol as a solvent.
- Recommend to avoid cleaning the LEDs by ultrasonic. If necessary, pre-test the LED is necessary to confirm whether any damage occur after the process.

Revision History

PC35N33 V0
Product Specification

Date	Contents	Writer	Approved
2017.07.04	NEW VERSION	Rudess	Bemore
2017.08.07	1. Update Reliability test – P.9 2. Soldering Notice and Conditions – P.13	Rudess	Bemore
2018.03.11	Update Outline Dimension – P.4	Rudess	Bemore
2018.05.28	Update Carrier Taping – P.10	Rudess	Bemore
2018.07.27	Update O.E. data – P.8~9	Rudess	Bemore

Smart Lighting *Amazing Life*

Lextar Electronics Corp. is the leading LED (Light Emitting Diode) maker integrating upper stream epitaxial, middle stream chip, and downstream package, SMT and LED lighting applications. Founded in May, 2008, Lextar is a subsidiary of AU Optronics, the leading TFT-LCD and solar PV manufacturer. Lextar's product applications include lighting and LCD backlight. Lextar's manufacturing sites include Hsinchu and Chunan in Taiwan, and Suzhou in China. The company turnover in 2010 is 266 million USD.