



晶采光電科技股份有限公司  
AMPIRE CO., LTD.

## SPECIFICATIONS FOR LCD MODULE

<b>CUSTOMER</b>	
<b>CUSTOMER PART NO.</b>	
<b>AMPIRE PART NO.</b>	<b>AM-800600K7TMQW-A1H</b>
<b>APPROVED BY</b>	
<b>DATE</b>	

Approved For Specifications

Approved For Specifications & Sample

**AMPIRE CO., LTD.**

**4F., No.116, Sec. 1, Xintai 5th Rd., Xizhi Dist., New Taipei City 221,  
Taiwan (R.O.C.) 22181 新北市 汐止區新台五路一段 116 號 4F**

**TEL:886-2-26967269 , FAX:886-2-26967196 or 26967270**

<b>APPROVED BY</b>	<b>CHECKED BY</b>	<b>ORGANIZED BY</b>

## RECORD OF REVISION

Revision Date	Page	Contents	Editor
2012/03/12	-	New Release	Kain
2012/07/03	3	Modification of Overall dimension	Kain
	8	Modification of Interface	Kain

## 1. INSTRUCTION

Ampire 10.4" Display Module is a color active matrix TFT-LCD that uses amorphous silicon TFT as a switching device . This model is composed of a TFT-LCD panel , a driving circuit with LVDS interface 、backlight. This TFT-LCD has a high resolution (800(R.G.B) X 600) and can display up to 262,144 colors.

### 1.1 Features

- (1) Construction : a-Si TFT-LCD with driving system, White LED Backlight.
- (2) LCD type : Transmissive , Normally White
- (3) Number of the Colors : 262K colors (R,G,B 6 bit digital each)
- (4) LVDS Interface.
- (5) LCD Power Supply Voltage: 3.3V single power input, built-in power supply circuit.
- (6) LED Driver Power Supply Voltage: 6~15V. PWM brightness dimming (10~200KHz)

## 2. PHYSICAL SPECIFICATIONS

Item	Specifications	unit
Display resolution	800RGB (W) x 600(H)	dots
Display size	10.4" (diagonal)	inch
Viewing Angle	6 o'clock (Gray Inversion)	-
Active area	211.2 (W) x 158.4(H)	mm
Pixel pitch	0.264 (W) x 0.264 (H)	um
Color configuration	R.G.B -stripe	-
Overall dimension	236.0(W)x176.9(H)x8.7(D)	mm
Backlight unit	LED	-
Brightness	500	cd/m2
Display color	262,144	colors
Contrast ratio	500	-
Power consumption	3.45	watt

### 3. ABSOLUTE MAXIMUM RATINGS

Item	Symbol	Min.	Max.	Unit	Note
Power voltage	V <sub>DD</sub>	-0.3	4.0	V	GND=0V
Voltage range at any terminal	V <sub>IN</sub>	-0.3	V <sub>DD</sub> +0.3	V	Note(1)
LED driving voltage	V <sub>LED</sub>	-0.3	15	V	
Operating Temperature	T <sub>op</sub>	-20	70	°C	
Storage Temperature	T <sub>stg</sub>	-30	80	°C	

Note (1) : V<sub>IN</sub> represents IN0±, IN1±, IN2±, CLK±

### 4. OPTICAL CHARACTERISTICS

Item	Symbol	Conditions	Min	Typ	Max	Unit	Note	
Contrast Ration	CR	Viewing normal angle	-	500	-	-	(2)	
Response Time	TR	$\theta_x = \theta_y = 0$	-	5	10	ms	(1)	
	TF		-	15	20	ms		
Viewing Angle	Hor.	Center CR>10	$\theta_{x+}$	-	70	-	deg	(5)
			$\theta_{x-}$	-	70	-	deg	
	Ver.		$\theta_{y+}$	-	50	-	deg	
			$\theta_{y-}$	-	60	-	deg	
Module Chromaticity	Red	Viewing normal angle $\theta_x = \theta_y = 0$	XR	0.550	0.600	0.650		
			YR	0.294	0.344	0.394		
	Green		XG	0.304	0.354	0.404		
			YG	0.529	0.579	0.629		
	Blue		XB	0.105	0.155	0.205		
			YB	0.076	0.126	0.176		
	White		XW	0.240	0.290	0.340		
			YW	0.268	0.318	0.368		
Brightness	-	I <sub>F</sub> =120mA	400	500	-	cd/m <sup>2</sup>	(4)	

(1) Definition of Response Time (White-Black)

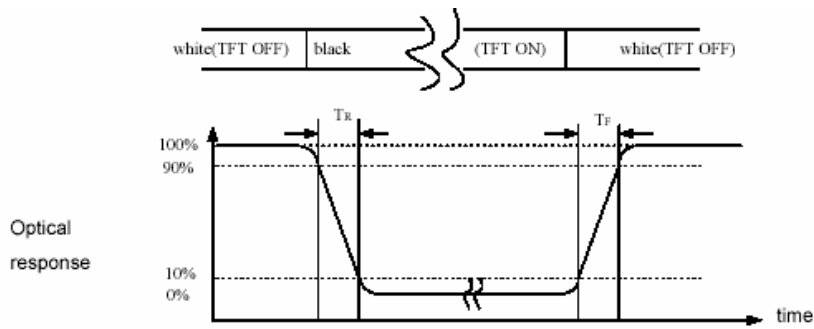

(2) Definition of Contrast Ratio

Measure contrast ratio on the below 5 points(refer to figure1,#1~#5point) and take the average value

Contrast ratio is calculated with the following formula :

$$\text{Contrast Ratio(CR)} = (\text{White})\text{Luminance of ON} \div (\text{Black})\text{Luminance of OFF}$$

(3) Definition of Luminance :

Measure the luminance of white state at **center point**.

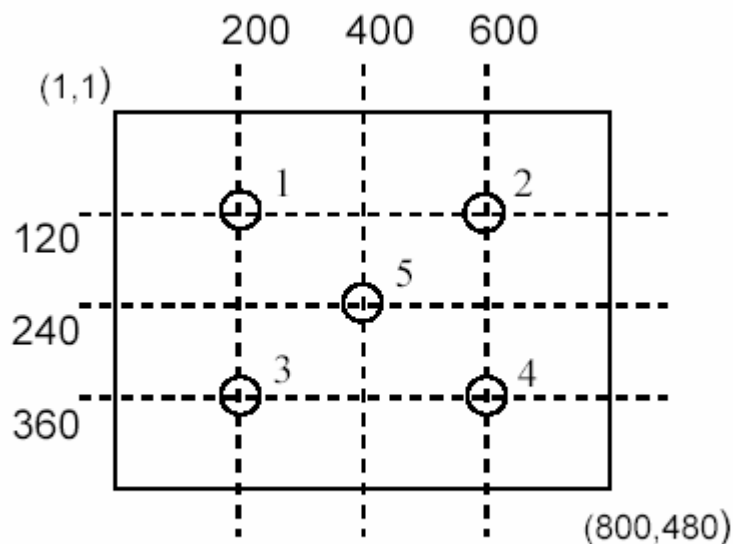

Fig.1 Measuring point

(4) Definition of Luminance Uniformity :

Measured Maximum luminance[L(MAX)] and Minimum luminance[L(MIN)] on the 5 points

Luminance Uniformity is calculated with the following formula :

$$\Delta L = [ L(\text{MIN}) / L(\text{MAX}) ] \times 100\%$$

(5) Definition of Viewing Angle

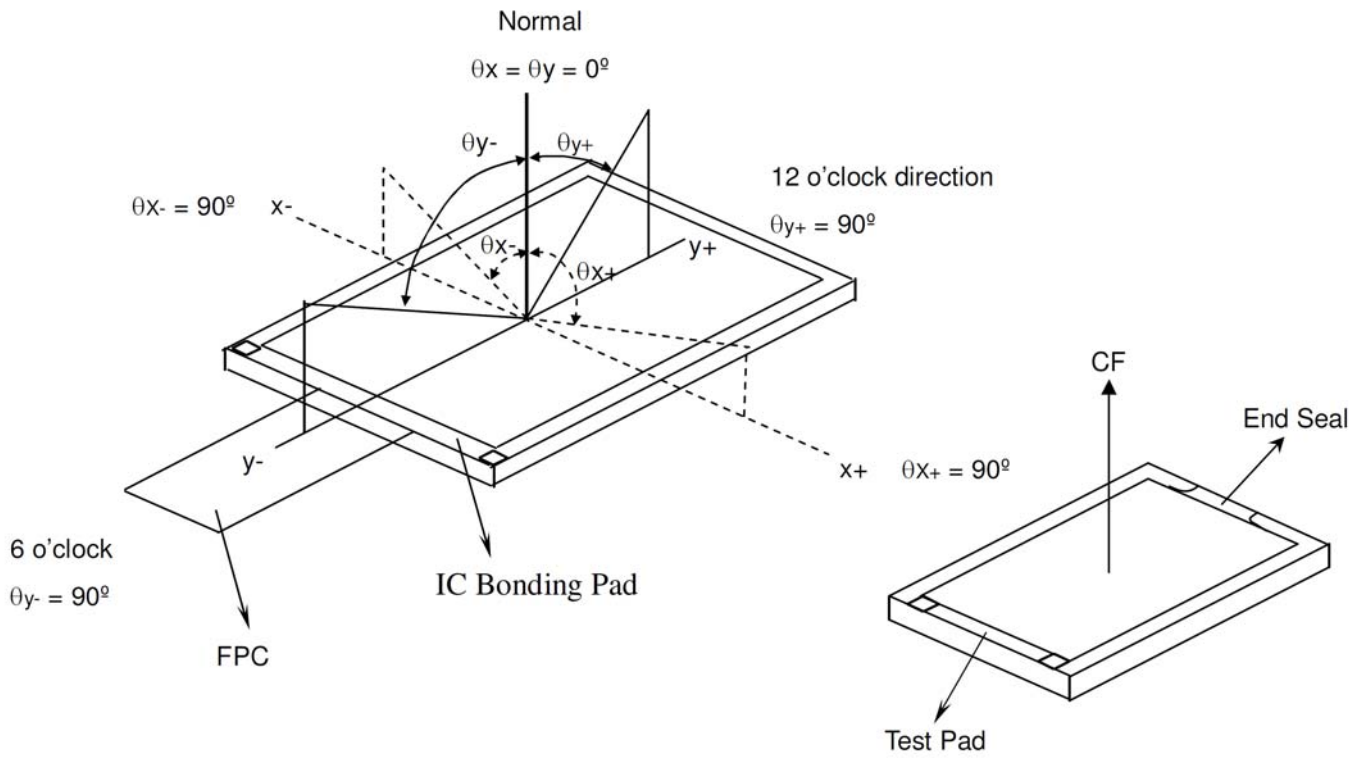

## 5. ELECTRICAL CHARACTERISTICS

Item	Symbol	Min	Typ	Max	Unit	Note
Power Voltage	$V_{DD}$	-	3.3	-	V	
Power Current	$I_{DD}$	-	110	-	mA	
High-level Input Voltage	$V_{IH}$	$0.8V_{DD}$	-	$V_{DD}$	V	
Low-level Input Voltage	$V_{IL}$	GND	-	$0.2V_{DD}$	V	
LED Driving Voltage	$V_{LED}$	6	12	15	V	
PWM Voltage	$V_{ADJ}$	2.0	--	3.3	V	

Note :  $V_{ADJ}$  maximum/minimum voltage and frequency maximum/minimum value as below.

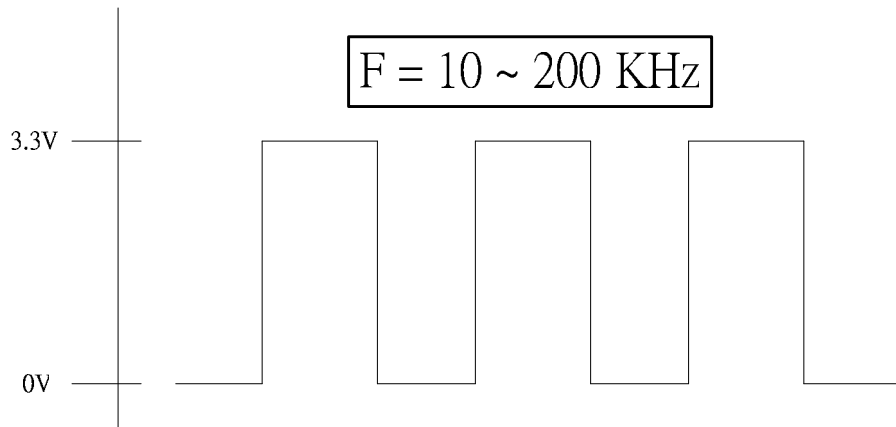

## 6. Backlight Driving Circuit

Item	Symbol	Min	Typ	Max	Unit	Note
Forward Current	$I_F$	-	120.0	-	mA	$T = 25^{\circ}\text{C}$
Forward Voltage	$V_F$	-	19.2	-	V	$I_F = 120 \text{ mA}$
Backlight Power Consumption	$W_{BL}$	-	2304	-	mW	Note(1)
Life Time	-	-	20K	-	hrs	$I_F = 120 \text{ mA}$ Note(2)

Note 1: LED connection of backlight shown as below:

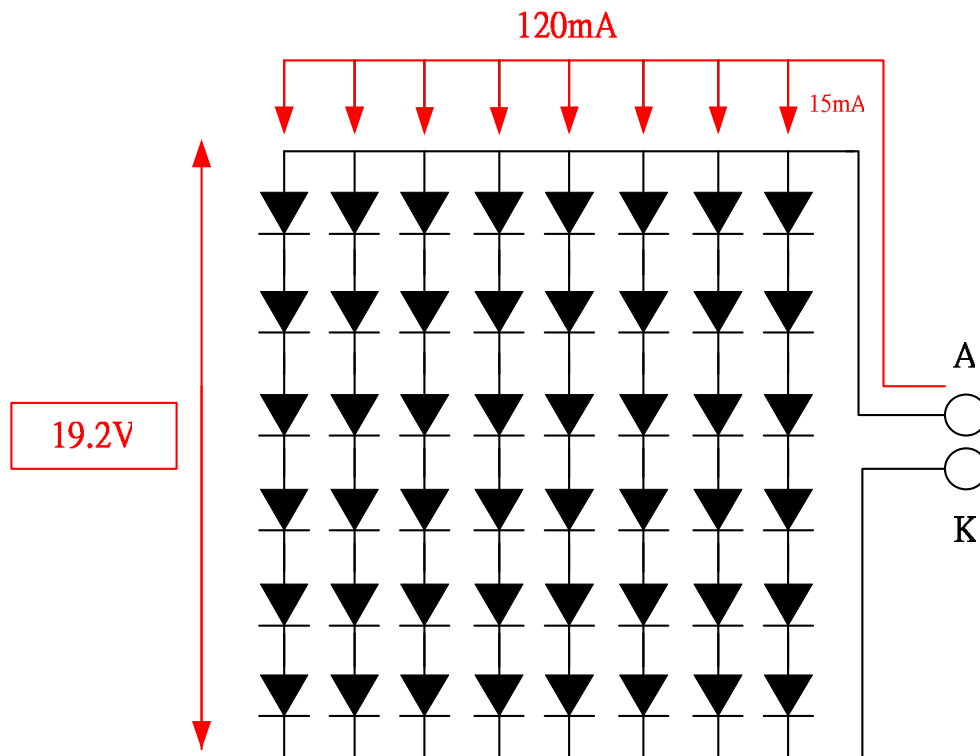

Note2: The brightness reduces to half of minimum value.

## 7. INTERFACE

CN1:

Pin no	Symbol	Function
1	VDD	Power supply for digital circuit (3.3V)
2	VDD	Power supply for digital circuit (3.3V)
3	GND	Power Ground
4	GND	Power Ground
5	IN0-	Transmission Data of Pixels 0
6	IN0+	Transmission Data of Pixels 0
7	GND	Power Ground
8	IN1-	Transmission Data of Pixels 1
9	IN1+	Transmission Data of Pixels 1
10	GND	Power Ground
11	IN2-	Transmission Data of Pixels 2
12	IN2+	Transmission Data of Pixels 2
13	GND	Power Ground
14	CLK-	Sampling Clock
15	CLK+	Sampling Clock
16	GND	Power Ground
17	NC	No Connection
18	NC	No Connection
19	GND	Power Ground
20	GND	Power Ground



**J2:**

Pin no	Symbol	Function
1	VLED	LED driving voltage (12.0V)
2	LED_EN	LED driving enable signal (3.3V)
3	GND	Ground
4	VADJ	Adjust the LED brightness by PWM

**8. AC Timing characteristic of the LVDS**

Following figure shows the relationship between input signal and LCD pixel format.

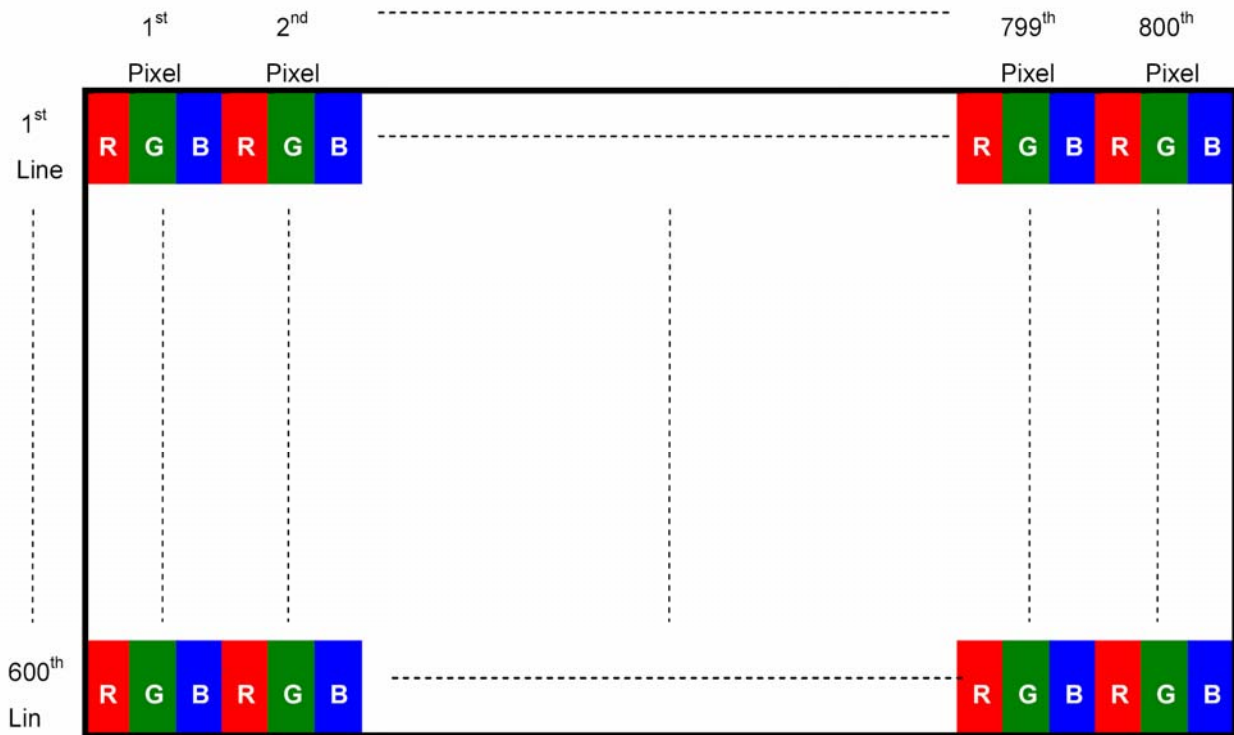

Parameter	Symbol	Spec.			Unit
		Min.	Typ.	Max.	
HS setup time	$T_{hst}$	8	-	-	ns
HS hold time	$T_{hhd}$	8	-	-	ns
VS setup time	$T_{vst}$	8	-	-	ns
VS hold time	$T_{vhd}$	8	-	-	ns
Data setup time	$T_{dsu}$	8	-	-	ns
Data hold time	$T_{dhd}$	8	-	-	ns
DE setup time	$T_{esu}$	8	-	-	ns
DE hold time	$T_{ehd}$	8	-	-	ns
VDD Power On Slew rate	$T_{POR}$	-	-	20	ms
RSTB pulse width	$T_{Rst}$	10	-	-	$\mu$ s
CLKIN cycle time	$T_{cph}$	20	-	-	ns
CLKIN pulse duty	$T_{cwh}$	40	50	60	%
Output stable time	$T_{sst}$	-	-	6	$\mu$ s

- **Horizontal Timing**

Parameter	Symbol	Spec.			Unit
		Min.	Typ.	Max.	
Horizontal Display Area	thd	800			DCLK
DCLK frequency	fclk	-	40	50	MHz
One Horizontal Line	th	862	1056	1200-	DCLK
HS pulse width (Min.)	thpw	1			DCLK
HS pulse width (Typical.)	thpw	-			DCLK
HS pulse width (Max.)	thpw	40			DCLK
HS Back Porch (Blanking)	thb	46	46	46	DCLK
HS Front Porch	thfp	16	210	354	DCLK

- **Vertical Timing**

Parameter	Symbol	Spec.			Unit
		Min.	Typ.	Max.	
Vertical Display Area	tvd	600			$T_H$
VS period time	tv	624	635	700	$T_H$
VS pulse width	tvpw	1	-	20	$T_H$
VS Back Porch (Blanking)	tvb	23	23	23	$T_H$
VS Front Porch	tvfp	1	12	77	$T_H$

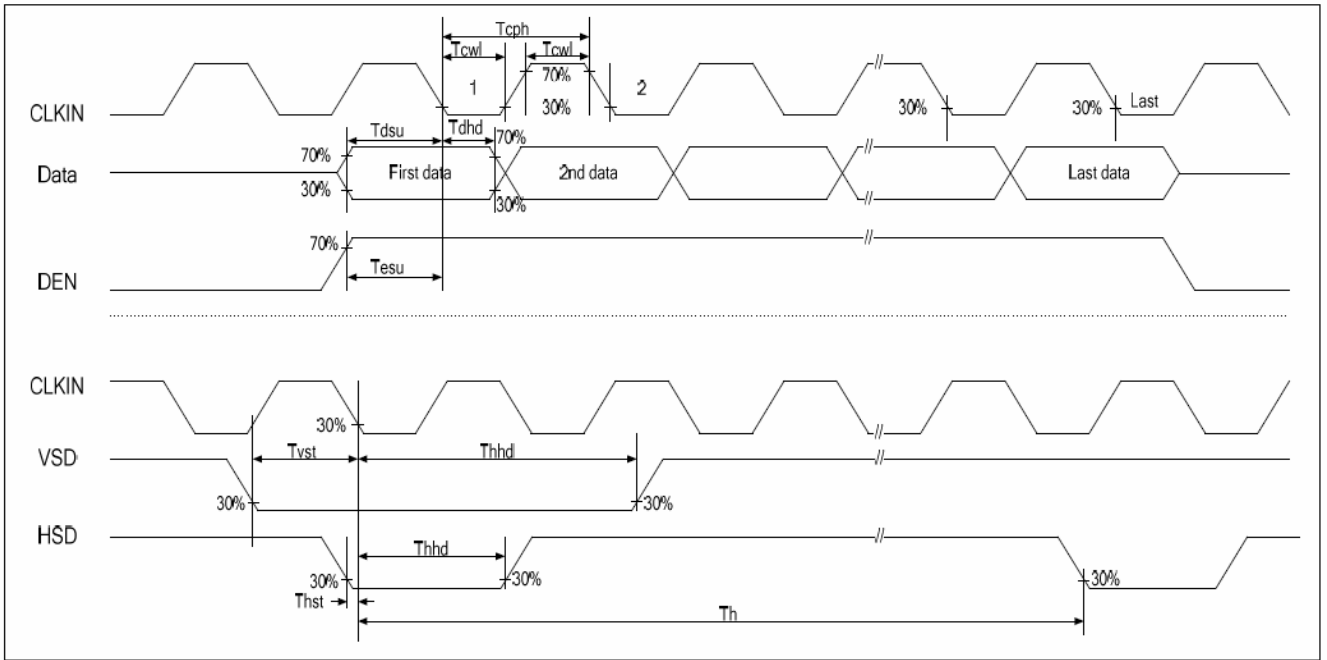

## 9 . Inspection Specifications

### 1. Scope

Specifications contain

- 1.1 Display Quality Evaluation
- 1.2 Mechanics Specification

### 2. Sampling Plan

Unless there is other agreement, the sampling plan for incoming inspection shall follow MIL-STD-105E LEVEL II.

- 2.1 Lot size: Quantity per shipment as one lot (different model as different lot ).
- 2.2 Sampling type: Normal inspection, single sampling.
- 2.3 Sampling level: Level II.
- 2.4 AQL: Acceptable Quality Level
  - Major defect: AQL=0.65
  - Minor defect: AQL=1.0

### 3. Panel Inspection Condition

#### 3.1 Environment:

- Room Temperature:  $25\pm 5^{\circ}\text{C}$ .
- Humidity:  $65\pm 5\%$  RH.
- Illumination: 300 ~ 700 Lux.

#### 3.2 Inspection Distance:

35-40 cm

#### 3.3 Inspection Angle:

The vision of inspector should be perpendicular to the surface of the Module.

#### 3.4 Inspection time :

Perceptibility Test Time: 20 seconds max.

### 4. Display Quality

#### 4.1 Function Related:

The function defects of line defect, abnormal display, and no display are considered Major defects.

#### 4.2 Bright/Dark Dots:

Defect Type / Specification	G0 Grade	A Grade
Bright Dots	0	$N \leq 3$
Dark Dots	0	$N \leq 4$
Total Bright and Dark Dots	0	$N \leq 6$

#### [Note 1]

Judge defect dot and adjacent dot as following.

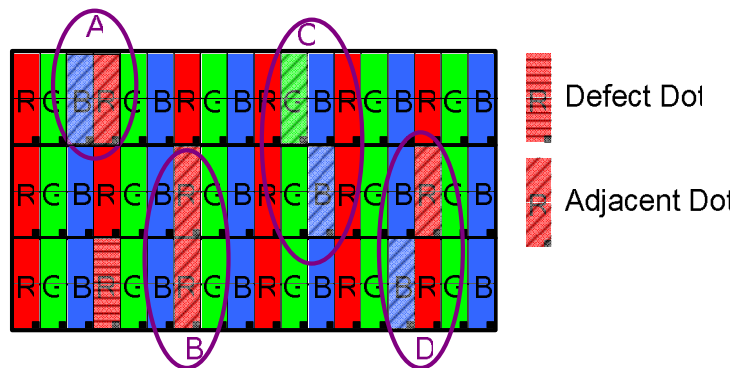

- (1) One pixel consists of 3 sub-pixels, including R,G, and B dot.(Sub-pixel = Dot)
- (2) The definition of dot: The size of a defective dot over 1/2 of whole dot is regarded as one defective dot.
- (3) Allow above (as A, B, C and D status) adjacent defect dots, including bright and dark adjacent dot. And they will be counted 2 defect dots in total quantity.
- (4) Defects on the Black Matrix, out of Display area, are not considered as a defect or counted.
- (5) There should be no distinct non-uniformity visible through 3% ND Filter within 2 sec inspection times.

4.3 Visual Inspection specifications:

Defect Type	Specification	Count(N)
Dot Shape (Particle, Scratch and Bubbles in display area)	$D \leq 0.25\text{mm}$	Ignored
	$0.25\text{mm} < D \leq 0.5\text{mm}$	$N \leq 3$
	$D > 0.5\text{mm}$	$N=0$
Line Shape (Particles, Scratch, Lint and Bubbles in display area)	$W \leq 0.07\text{mm}$	Ignored
	$0.07\text{mm} < W \leq 0.1\text{mm}$ , $L \leq 5\text{mm}$	$N \leq 3$
	$W > 0.1\text{mm}$ , $L > 5\text{mm}$	$N=0$

[Note 2] W : Width[mm], L : Length[mm], N : Number,  $\phi$  : Average Diameter

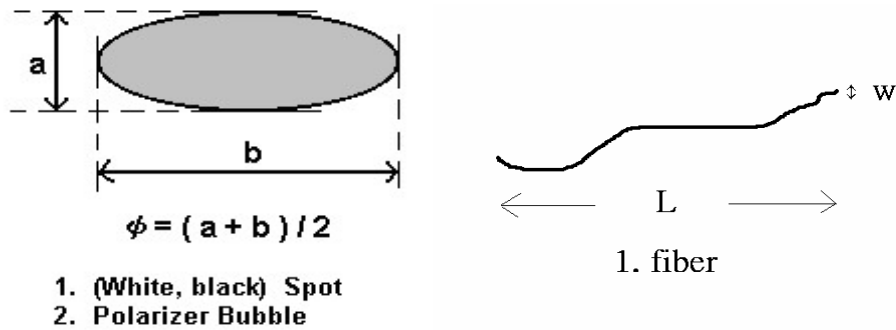

[Note 3] Bright dot is defined through 3% transmission ND Filter as following.

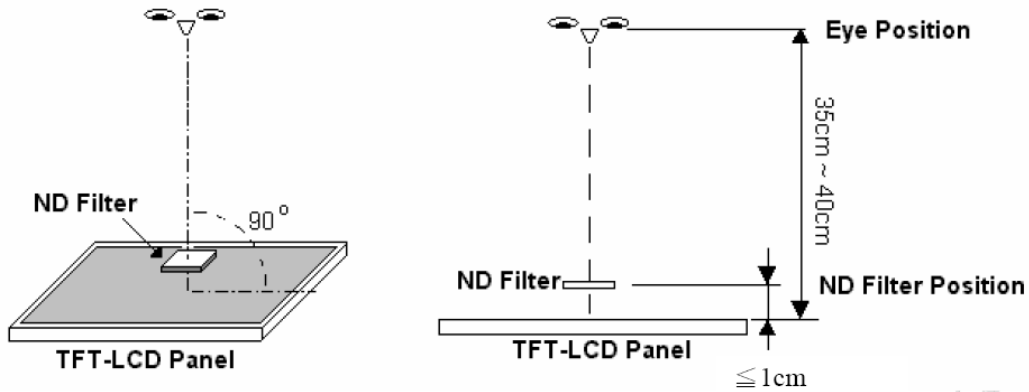

## 10. QUALITY AND RELIABILITY

Test Item	Test Conditions	Note
High Temperature Operation	70±3°C , t=240 hrs	
Low Temperature Operation	-20±3°C , t=240 hrs	
High Temperature Storage	80±3°C , t=240 hrs	1,2
Low Temperature Storage	-30±3°C , t=240 hrs	1,2
Thermal Shock Test	-20°C ~ 25°C ~ 70°C 30 m in. 5 min. 30 min. ( 1 cycle ) Total 5 cycle	1,2
Humidity Test	60 °C, Humidity 90%, 240 hrs	1,2
Vibration Test (Packing)	Sweep frequency : 10 ~ 55 ~ 10 Hz/1min Amplitude : 0.75mm Test direction : X.Y.Z/3 axis Duration : 30min/each axis	2

Note 1 : Condensation of water is not permitted on the module.

Note 2 : The module should be inspected after 1 hour storage in normal conditions  
(15-35°C , 45-65%RH).

Definitions of life end point :

- Current drain should be smaller than the specific value.
- Function of the module should be maintained.
- Appearance and display quality should not have degraded noticeably.
- Contrast ratio should be greater than 50% of the initial value.

## **11 USE PRECAUTIONS**

### **11.1 Handling precautions**

- 1) The polarizing plate may break easily so be careful when handling it. Do not touch, press or rub it with a hard-material tool like tweezers.
- 2) Do not touch the polarizing plate surface with bare hands so as not to make it dirty. If the surface or other related part of the polarizing plate is dirty, soak a soft cotton cloth or chamois leather in benzine and wipe off with it. Do not use chemical liquids such as acetone, toluene and isopropyl alcohol. Failure to do so may bring chemical reaction phenomena and deteriorations.
- 3) Remove any spit or water immediately. If it is left for hours, the suffered part may deform or decolorize.
- 4) If the LCD element breaks and any LC stuff leaks, do not suck or lick it. Also if LC stuff is stuck on your skin or clothing, wash thoroughly with soap and water immediately.

### **11.2 Installing precautions**

- 1) The PCB has many ICs that may be damaged easily by static electricity. To prevent breaking by static electricity from the human body and clothing, earth the human body properly using the high resistance and discharge static electricity during the operation. In this case, however, the resistance value should be approx.  $1M\Omega$  and the resistance should be placed near the human body rather than the ground surface. When the indoor space is dry, static electricity may occur easily so be careful. We recommend the indoor space should be kept with humidity of 60% or more. When a soldering iron or other similar tool is used for assembly, be sure to earth it.
- 2) When installing the module and ICs, do not bend or twist them. Failure to do so may crack LC element and cause circuit failure.
- 3) To protect LC element, especially polarizing plate, use a transparent protective plate (e.g., acrylic plate, glass etc) for the product case.
- 4) Do not use an adhesive like a both-side adhesive tape to make LCD surface (polarizing plate) and product case stick together. Failure to do so may cause the polarizing plate to peel off.

### **11.3 Storage precautions**

- 1) Avoid a high temperature and humidity area. Keep the temperature between  $0^{\circ}\text{C}$  and  $35^{\circ}\text{C}$  and also the humidity under 60%.
- 2) Choose the dark spaces where the product is not exposed to direct sunlight or fluorescent light.
- 3) Store the products as they are put in the boxes provided from us or in the same conditions as we recommend.



#### **11.4 Operating precautions**

- 1) Do not boost the applied drive voltage abnormally. Failure to do so may break ICs. When applying power voltage, check the electrical features beforehand and be careful. Always turn off the power to the LC module controller before removing or inserting the LC module input connector. If the input connector is removed or inserted while the power is turned on, the LC module internal circuit may break.
- 2) The display response may be late if the operating temperature is under the normal standard, and the display may be out of order if it is above the normal standard. But this is not a failure; this will be restored if it is within the normal standard.
- 3) The LCD contrast varies depending on the visual angle, ambient temperature, power voltage etc. Obtain the optimum contrast by adjusting the LC drive voltage.
- 4) When carrying out the test, do not take the module out of the low-temperature space suddenly. Failure to do so will cause the module condensing, leading to malfunctions.
- 5) Make certain that each signal noise level is within the standard (L level: 0.2V<sub>dd</sub> or less and H level: 0.8V<sub>dd</sub> or more) even if the module has functioned properly. If it is beyond the standard, the module may often malfunction. In addition, always connect the module when making noise level measurements.
- 6) The CMOS ICs are incorporated in the module and the pull-up and pull-down function is not adopted for the input so avoid putting the input signal open while the power is ON.
- 7) The characteristic of the semiconductor element changes when it is exposed to light emissions, therefore ICs on the LCD may malfunction if they receive light emissions. To prevent these malfunctions, design and assemble ICs so that they are shielded from light emissions.
- 8) Crosstalk occurs because of characteristics of the LCD. In general, crosstalk occurs when the regularized display is maintained. Also, crosstalk is affected by the LC drive voltage. Design the contents of the display, considering crosstalk.

#### **11.5 Other**

- 1) Do not disassemble or take the LC module into pieces. The LC modules once disassembled or taken into pieces are not the guarantee articles.
- 2) The residual image may exist if the same display pattern is shown for hours. This residual image, however, disappears when another display pattern is shown or the drive is interrupted and left for a while. But this is not a problem on reliability.
- 3) AMIPRE will provide one year warranty for all products and three months warrantee for all repairing products.

# 12. OUTLINE DIMENSION

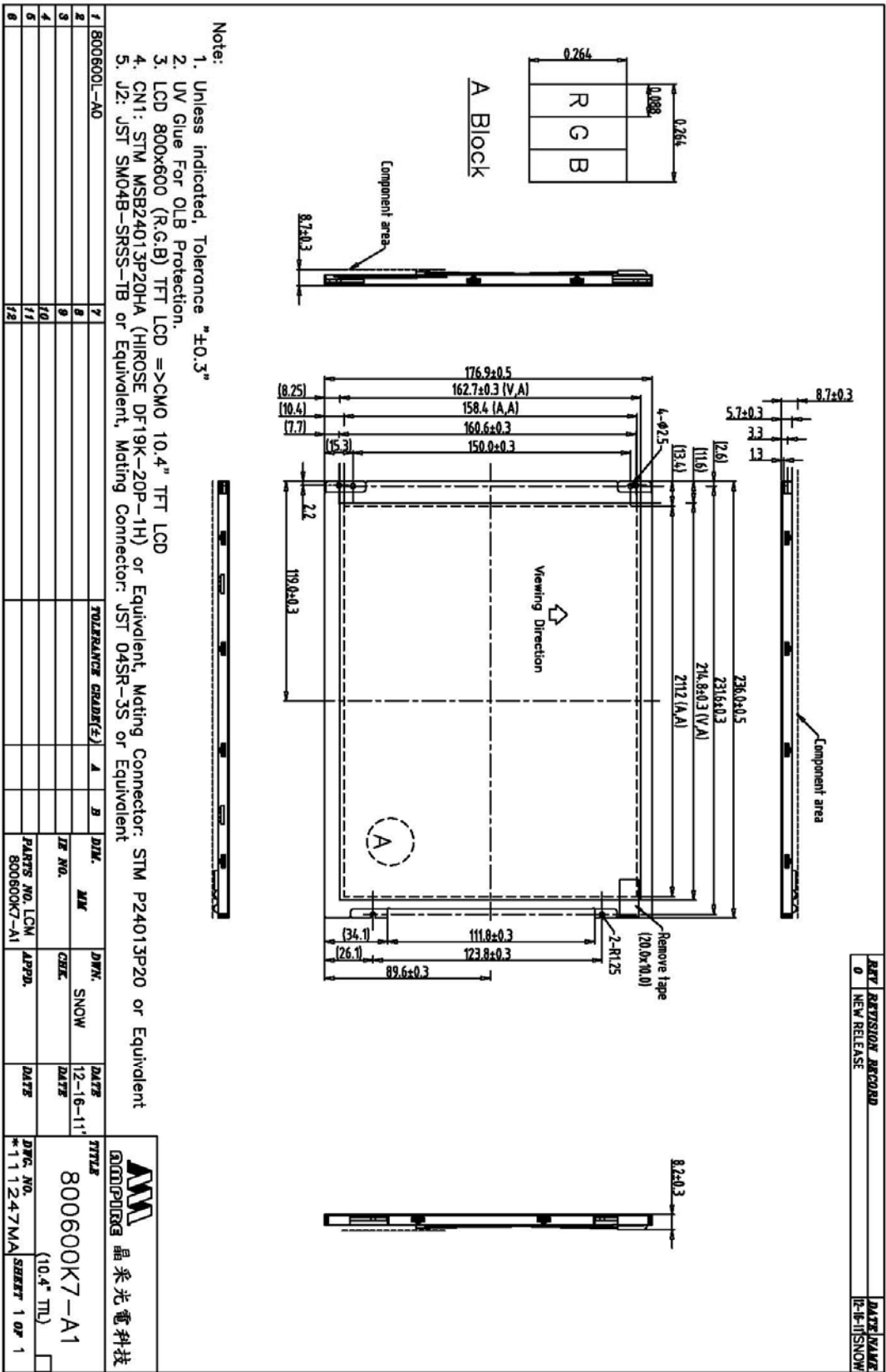

REV	REVISION RECORD	DATE	NAME
0	NEW RELEASE	12-11-11	SNOW

1	VLED
2	LED_EN
3	GND
4	ADJ

1	VDD	11	IN2-
2	VDD	12	IN2+
3	GND	13	GND
4	GND	14	CLK-
5	INO-	15	CLK+
6	INO+	16	GND
7	GND	17	NC.
8	IN1-	18	NC.
9	IN1+	19	GND
10	GND	20	GND

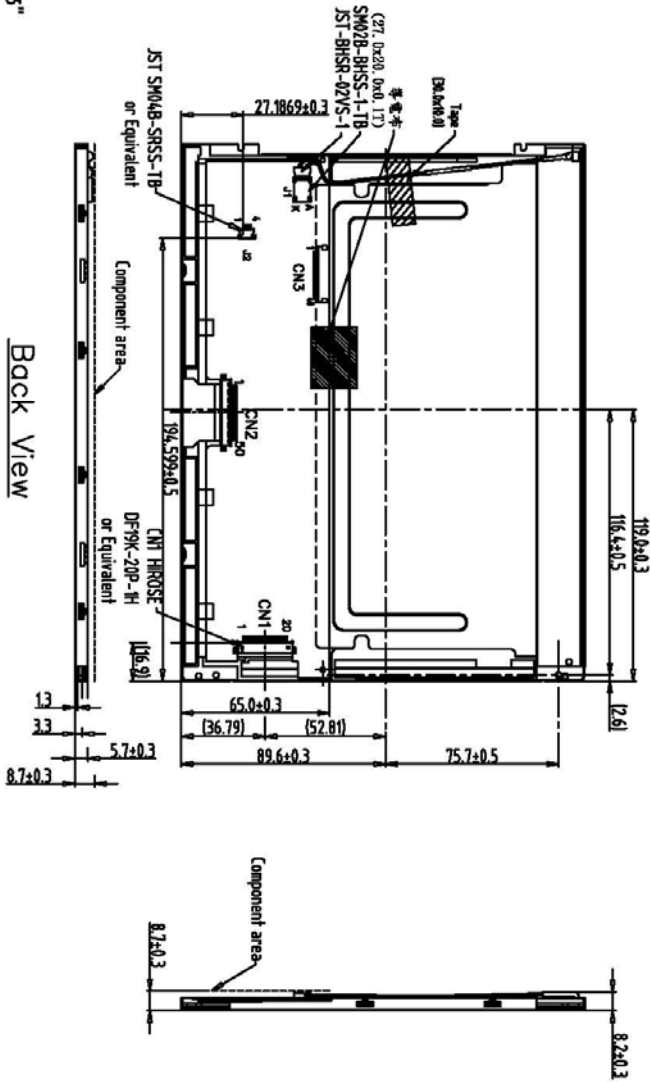

- Note:
1. Unless indicated, Tolerance "±0.3"
  2. UV Glue For OLB Protection.
  3. LCD 800x600 (R.G.B) TFT LCD =>CMO 10.4" TFT LCD
  4. CN1: STM MSB24013P20H4 (HIROSE DF19K-20P-1H) or Equivalent, Mating Connector: STM P24013P20 or Equivalent
  5. J2: JST SM04B-SRSS-TB or Equivalent, Mating Connector: JST 04SR-3S or Equivalent

1	TF800600-91A-0	7	7	TOLERANCE GRAB(E)	A	B	DIR.	MR	DIR.	SNOW	DATE	12-16-11	TTTLR	800600K7-A1	晶采光電科技	DWG. NO.	*111248MA	SHEET	1 OF 1
2		8	8								DATE								
3		9	9								DATE								
4		10	10								DATE								
5		11	11								DATE								
6		12	12								DATE								

# 13. Packing

Note:

1. Bag = 1 PCS LCM
2. Big Box = 1x 25 = 25 PCS LCM

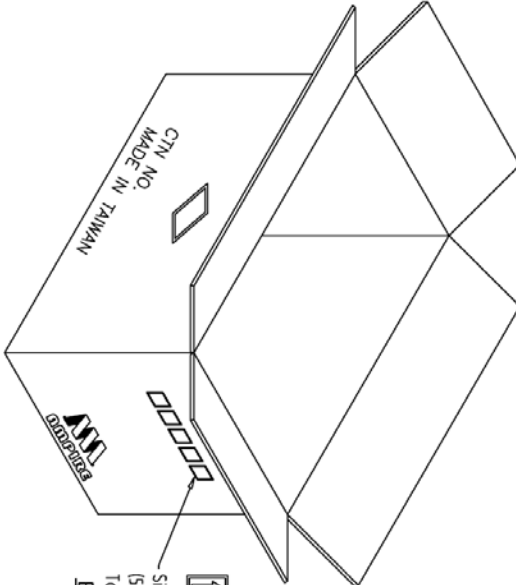
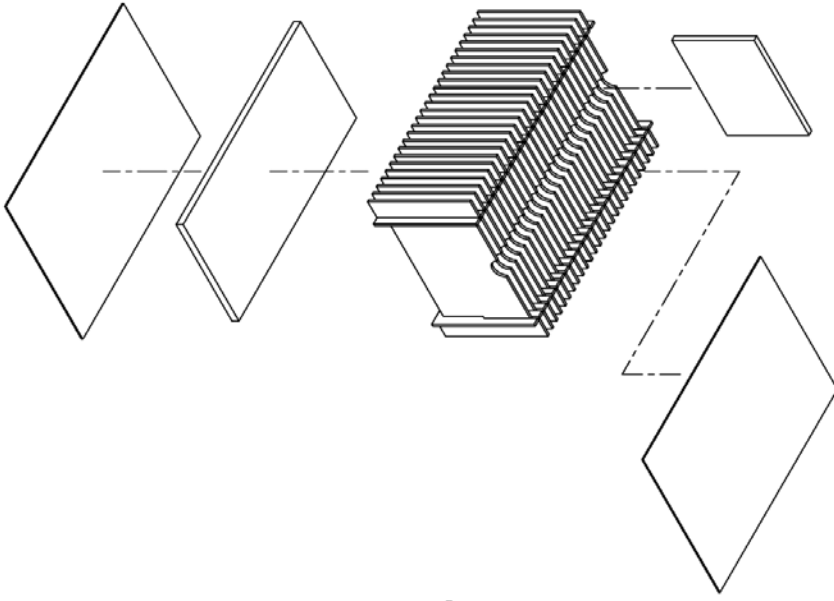

Size L x W x H  
 (527.0x364.0x248.0mm)  
 Tolerance:±100  
 Big\_Box



REV.	REVISION RECORD	DATE	NAME
0	NEW RELEASE		IR-I@SNOW
1	Rename TF800600-41-0 to 800600L-00		IR-I@SNOW

ITEM NO.	DESCRIPTION	TOLERANCE GRADE(F)	A	B	DIM.	MM	DMN.	SNOW	DATE	TITLE
1	TF800600-41-0									
2		~6	0.05	0.1					09-17-09	800600L-TD0
3		6~18	0.08	0.18	IE NO.		CHK.		DATE	
4		18~60	0.1	0.25						
5		60~180	0.2	0.4	PARTS NO. Packing		APPD.		DATE	
6		180~	0.3	0.5	800600L-TD0					

**AMPIRE** 晶采光電科技  
 800600L-TD0  
 (10.4")  
 Dwg. No. \*0909355A SHEET 1 OF 1