



晶采光電科技股份有限公司
AMPIRE CO., LTD.

SPECIFICATIONS FOR LCD MODULE

CUSTOMER	
CUSTOMER PART NO.	
AMPIRE PART NO.	AM-800600K1TMQW-03H
APPROVED BY	
DATE	

Approved For Specifications

Approved For Specifications & Sample

AMPIRE CO., LTD.

2F., No.88, Sec. 1, Xintai 5th Rd., Xizhi Dist., New Taipei City 221, Taiwan
(R.O.C.)

22181 新北市 汐止區 新台五路一段 88 號 2 樓

TEL:886-2-26967269 , FAX:886-2-26967196 or 26967270

APPROVED BY	CHECKED BY	ORGANIZED BY

RECORD OF REVISION

Revision Date	Page	Contents	Editor
2013/08/01	-	New Release	Simon

1. INSTRUCTION

Ampire 10.4" Display Module is a color active matrix TFT-LCD that uses amorphous silicon TFT as a switching device . This model is composed of a TFT-LCD panel , a driving circuit , power supply circuit and a LED backlight system . This TFT-LCD has a high resolution SVGA(800(R.G.B) X 600) and can display up to 16.2M colors.

1-1. Features

- 10.4" (diagonal) configuration
- Input interface voltage : 3.3V
- LCD type : Transmissive , Normally White
- 6 Bits LVDS Interface

1-2. Applications

- Portable TV
- Car user DVD

2. PHYSICAL SPECIFICATIONS

Item	Specifications	unit
Display resolution(dot)	800RGB (W) x 600(H)	dots
Active area	211.2 (W) x 158.4(H)	mm
View area	214.8(W) x 162.7(H)	mm
Pixel pitch	0.264 (W) x 0.264 (H)	mm
Color configuration	R.G.B -stripe	-
Overall dimension	243.0(W) x 185.6(H) x 7.2(D)	mm
Viewing direction	6 o'clock	-
Brightness	500	cd/m ²
Contrast ratio	500	-
Power Consumption	7500(Max)	mW
Display color	262K / 16.2M	color
Backlight unit	LED	-

3. ABSOLUTE MAX. RATINGS

3-1 Electrical Absolute Rating

3-1-1 TFT LCD Module

Item	Symbol	Values		UNIT	Note
		Min.	Max.		
Power voltage	V _{DD}	-0.3	4.0	V	GND=0V
Voltage range at any terminal	-	-0.3	V _{DD} +0.3	V	

3-2 Environment Absolute Rating

Item	Symbol	Min.	Max.	Unit	Note
Operating Temperature	Topa	-30	80	°C	
Storage Temperature	Tstg	-35	85	°C	

3-3 ELECTRICAL CHARACTERISTICS

Item	Symbol	Min	Typ	Max	Unit	Note
Power Voltage	V _{DD}	-	3.3	-	V	
LED Power Voltage	V _{CC}	-	12	-	V	
High-level Input Voltage	V _{IH}	0.8V _{CC}	-	V _{CC}	V	
Low-level Input Voltage	V _{IL}	GND	-	0.2V _{CC}	V	
Differential Input High Threshold	V _{TH}	-	-	0.1	V	
Differential Input Low Threshold	V _{TL}	-0.1	-	-	V	

4. OPTICAL CHARACTERISTICS

Item	Symbol	Conditions	Min	Typ	Max	Unit	Note	
Contrast Ration	CR	Viewing normal angle	-	500	-	-		
Response Time	T_R	$\theta_x = \theta_y = 0$	-	5	10	ms	(2)	
	T_F		-	15	20	ms		
Viewing Angle	Hor.	θ_{x+}	Center CR>10	-	70	-	deg	(3)
		θ_{x-}		-	70	-	deg	
	Ver.	θ_{y+}		-	50	-	deg	
		θ_{y-}		-	60	-	deg	
Module Chromaticity	Red	X_R	Viewing normal angle $\theta_x = \theta_y = 0$	0.550	0.600	0.650		
		Y_R		0.294	0.344	0.394		
	Green	X_G		0.304	0.354	0.404		
		Y_G		0.529	0.579	0.629		
	Blue	X_B		0.105	0.155	0.205		
		Y_B		0.076	0.126	0.176		
	White	X_W		0.240	0.290	0.340		
		Y_W		0.268	0.318	0.368		
Brightness	-	ILED = 240mA	-	500	-	Lux	(4)	

*Note(1) These items are measured by BM-7 in the dark room (no ambient light)

*Note(2) Definition of Response Time (T_R, T_F):

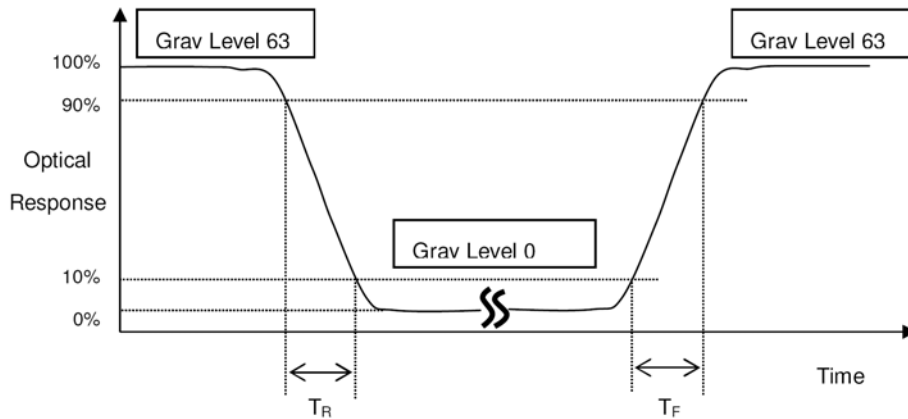

*Note(3) Definition of Viewing Angle

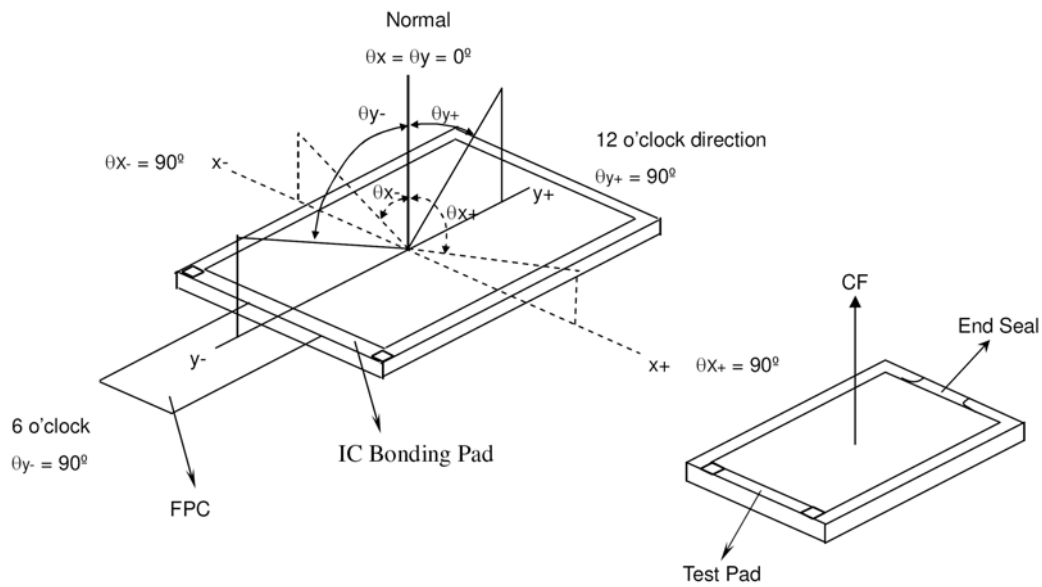

*Note(4) The Brightness is at the center of V.A(Viewing Area).

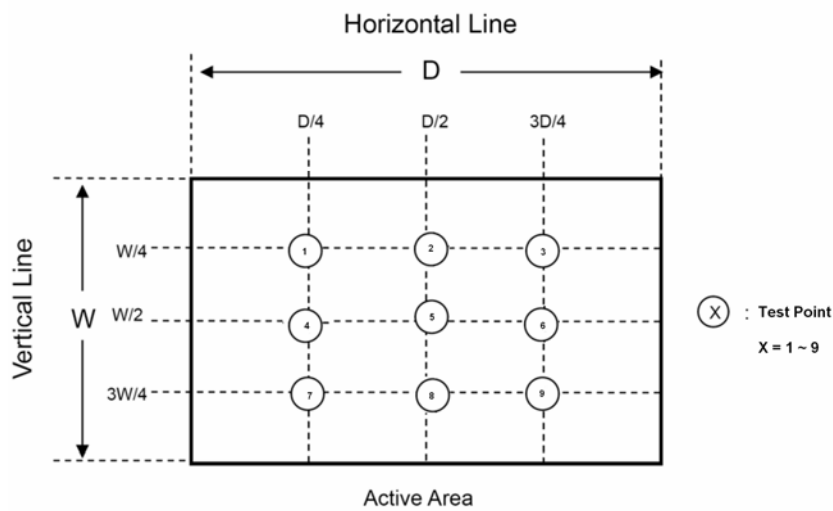

5. Backlight Driving Circuit

Item	Symbol	Min	Typ	Max	Unit	Note
LED Voltage	VLED	-	19.8	-	V	
LED Current	ILED	-	240	-	mA	
LED life time	-	-	50,000	-	Hr	
LED DRIVER Power Current	ICC(VCC=12V)	-	540	-	mA	
Swing Voltage	-	3	3.3	5.5	V	
Dimming duty cycle	-	5	-	100	%	

PWM Dimming Control

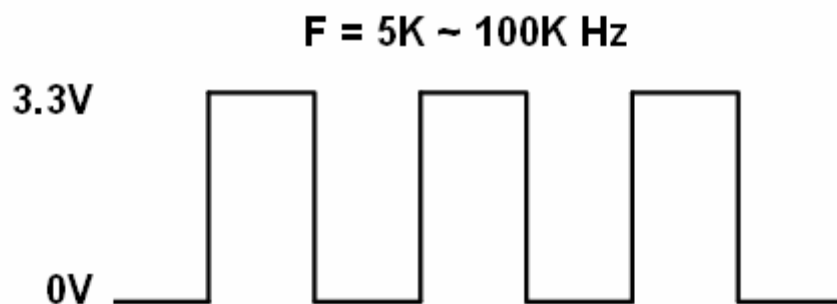
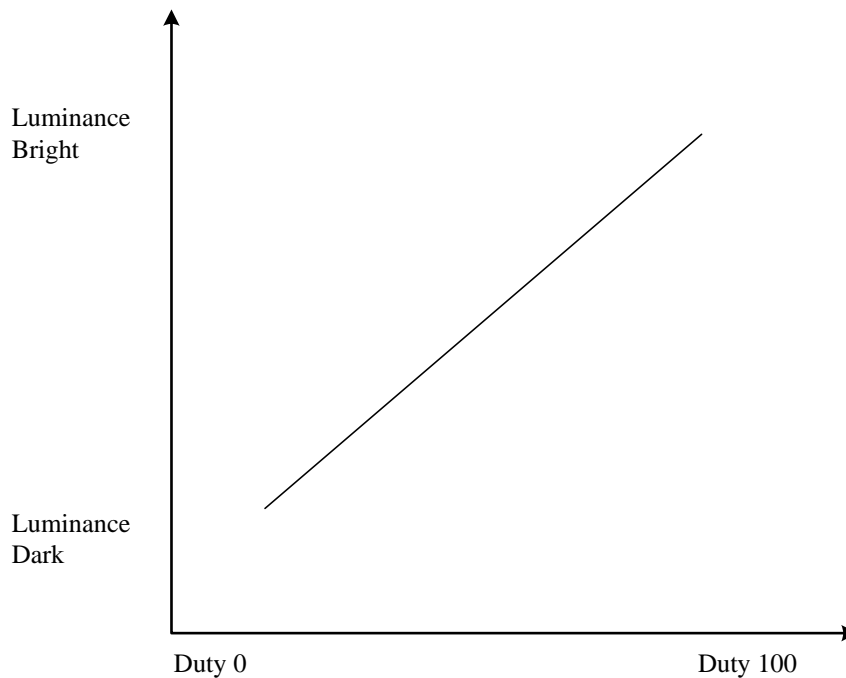

6. INTERFACE

CN1 : LCM PIN Definition

Pin no	Symbol	Function
1	VDD	Power Supply:3.3V
2	VDD	Power Supply:3.3V
3	GND	Power Ground
4	DPS	Reverse Scan Function [H:Enable ; L:Disable]
5	RxIN0-	Transmission Data of Pixels 0
6	RxIN0+	Transmission Data of Pixels 0
7	GND	Power Ground
8	RxIN1-	Transmission Data of Pixels 1
9	RxIN1+	Transmission Data of Pixels 1
10	GND	Power Ground
11	RxIN2-	Transmission Data of Pixels 2
12	RxIN2+	Transmission Data of Pixels 2
13	GND	Power Ground
14	RxCLKIN-	LVDS receiver signal clock
15	RxCLKIN+	LVDS receiver signal clock
16	GND	Power Ground
17	RSV	Reserved for internal test. Please treat it as NC
18	RSV	Reserved for internal test. Please treat it as NC
19	RSV	Reserved for internal test. Please treat it as NC
20	RSV	Reserved for internal test. Please treat it as NC

CN2 : Backlight adjustment PIN Definition

Pin no	Symbol	Function
1	VCC	Power Supply:12V
2	GND	Power Ground
3	ON/OFF	Function selection:5V-Backlight ON , GND-Backlight OFF
4	Dimming	Adjust brightness
5	N/A	No Connection

CN4 : Backlight Power Source PIN Definition

Pin no	Symbol	Function
1	A	Power 19.8V
2	K	Power Ground

7. Signal Characteristics

7.1 Pixel Format Image

Following figure shows the relationship between input signal and LCD pixel format.

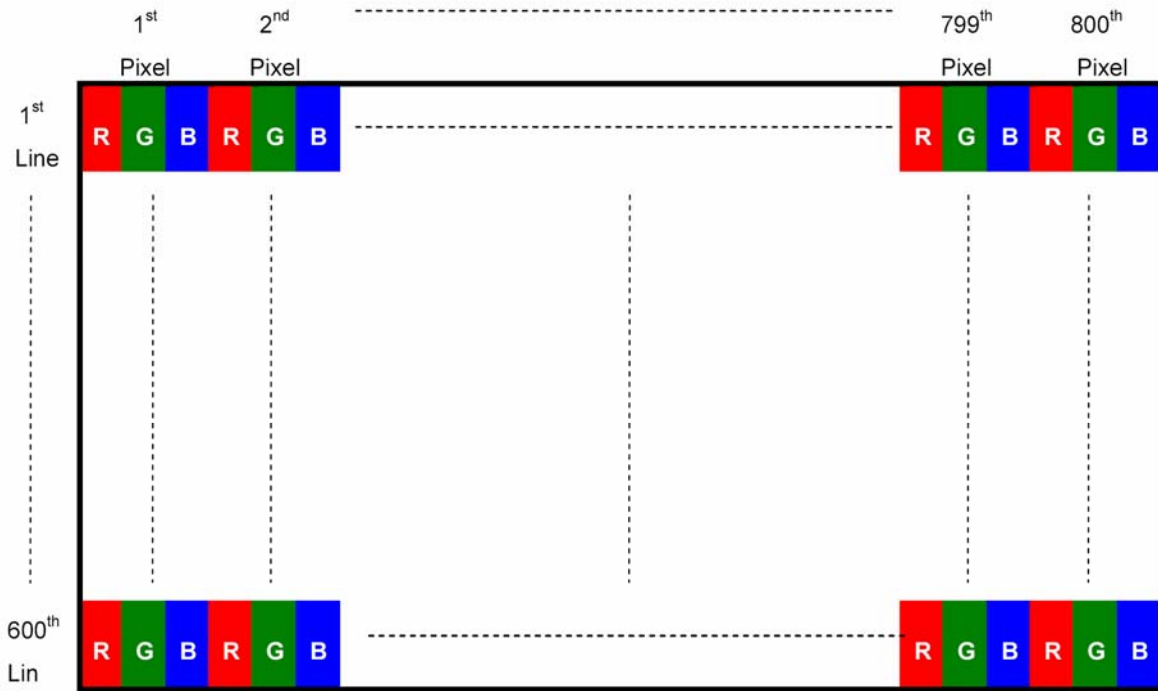

7.2 Scanning Direction

The following figures show the image seen from the front view. The arrow indicates the direction of scan.

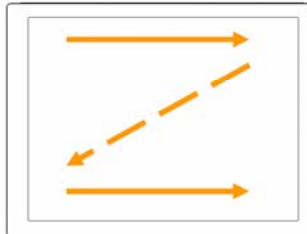

Fig. 1 Normal scan (Pin4, DPS = Low or NC)

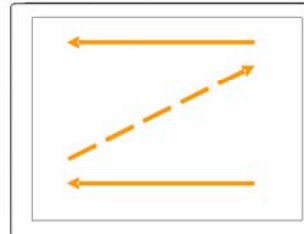

Fig. 2 Reverse scan (Pin4, DPS = High)

8 .Timing Characteristics

● Horizontal Timing

Parameter	Symbol	Spec.			Unit
		Min.	Typ.	Max.	
Horizontal Display Area	thd	800			DCLK
DCLK frequency	fclk	-	40	50	MHz
One Horizontal Line	th	862	1056	1200-	DCLK
HS pulse width (Min.)	thpw	1			DCLK
HS pulse width (Typical.)	thpw	-			DCLK
HS pulse width (Max.)	thpw	40			DCLK
HS Back Porch (Blanking)	thb	46	46	46	DCLK
HS Front Porch	thfp	16	210	354	DCLK

● Vertical Timing

Parameter	Symbol	Spec.			Unit
		Min.	Typ.	Max.	
Vertical Display Area	tvd	600			T_H
VS period time	tv	624	635	700	T_H
VS pulse width	tvpw	1	-	20	T_H
VS Back Porch (Blanking)	tvb	23	23	23	T_H
VS Front Porch	tvfp	1	12	77	T_H

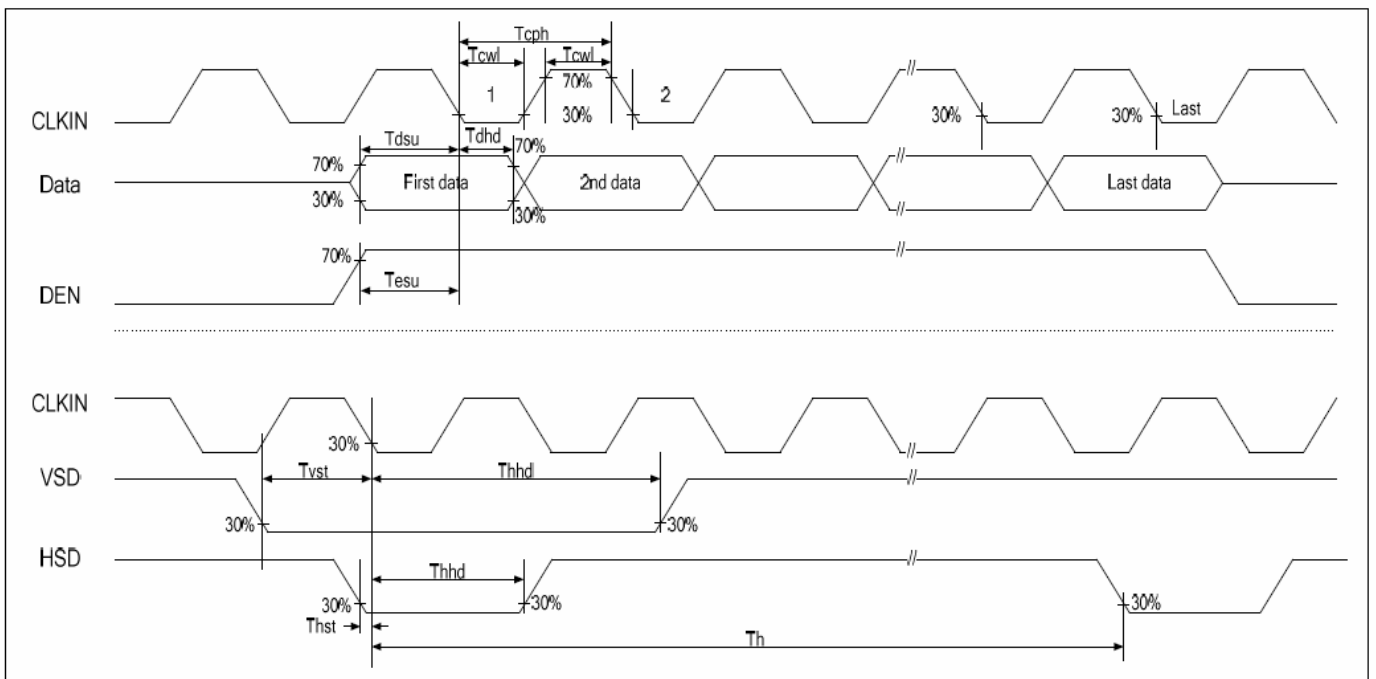

9. QUALITY AND RELIABILITY

Test Item	Test Conditions	Note
High Temperature Operation	80±3°C , t=240 hrs	
Low Temperature Operation	-30±3°C , t=240 hrs	
High Temperature Storage	85±3°C , t=240 hrs	1,2
Low Temperature Storage	-35±3°C , t=240 hrs	1,2
Thermal Shock Test	-20°C ~ 25°C ~ 70°C 30 m in. 5 min. 30 min. (1 cycle) Total 5 cycle	1,2
Humidity Test	60 °C, Humidity 90%, 240 hrs	1,2
Vibration Test (Packing)	Sweep frequency : 10 ~ 55 ~ 10 Hz/1min Amplitude : 0.75mm Test direction : X.Y.Z/3 axis Duration : 30min/each axis	2

Note 1 : Condensation of water is not permitted on the module.

Note 2 : The module should be inspected after 1 hour storage in normal conditions
(15-35°C , 45-65%RH).

Definitions of life end point :

- Current drain should be smaller than the specific value.
- Function of the module should be maintained.
- Appearance and display quality should not have degraded noticeably.
- Contrast ratio should be greater than 50% of the initial value.

10. USE PRECAUTIONS

10.1 Handling precautions

- 1) The polarizing plate may break easily so be careful when handling it. Do not touch, press or rub it with a hard-material tool like tweezers.
- 2) Do not touch the polarizing plate surface with bare hands so as not to make it dirty. If the surface or other related part of the polarizing plate is dirty, soak a soft cotton cloth or chamois leather in benzene and wipe off with it. Do not use chemical liquids such as acetone, toluene and isopropyl alcohol. Failure to do so may bring chemical reaction phenomena and deteriorations.
- 3) Remove any spit or water immediately. If it is left for hours, the suffered part may deform or decolorize.
- 4) If the LCD element breaks and any LC stuff leaks, do not suck or lick it. Also if LC stuff is stuck on your skin or clothing, wash thoroughly with soap and water immediately.

10.2 Installing precautions

- 1) The PCB has many ICs that may be damaged easily by static electricity. To prevent breaking by static electricity from the human body and clothing, earth the human body properly using the high resistance and discharge static electricity during the operation. In this case, however, the resistance value should be approx. $1M\Omega$ and the resistance should be placed near the human body rather than the ground surface. When the indoor space is dry, static electricity may occur easily so be careful. We recommend the indoor space should be kept with humidity of 60% or more. When a soldering iron or other similar tool is used for assembly, be sure to earth it.
- 2) When installing the module and ICs, do not bend or twist them. Failure to do so may crack LC element and cause circuit failure.
- 3) To protect LC element, especially polarizing plate, use a transparent protective plate (e.g., acrylic plate, glass etc) for the product case.
- 4) Do not use an adhesive like a both-side adhesive tape to make LCD surface (polarizing plate) and product case stick together. Failure to do so may cause the polarizing plate to peel off.

10.3 Storage precautions

- 1) Avoid a high temperature and humidity area. Keep the temperature between 0°C and 35°C and also the humidity under 60%.
- 2) Choose the dark spaces where the product is not exposed to direct sunlight or fluorescent light.
- 3) Store the products as they are put in the boxes provided from us or in the same conditions as we recommend.

10.4 Operating precautions

- 1) Do not boost the applied drive voltage abnormally. Failure to do so may break ICs. When applying power voltage, check the electrical features beforehand and be careful. Always turn off the power to the LC module controller before removing or inserting the LC module input connector. If the input connector is removed or inserted while the power is turned on, the LC module internal circuit may break.
- 2) The display response may be late if the operating temperature is under the normal standard, and the display may be out of order if it is above the normal standard. But this is not a failure; this will be restored if it is within the normal standard.
- 3) The LCD contrast varies depending on the visual angle, ambient temperature, power voltage etc. Obtain the optimum contrast by adjusting the LC drive voltage.
- 4) When carrying out the test, do not take the module out of the low-temperature space suddenly. Failure to do so will cause the module condensing, leading to malfunctions.
- 5) Make certain that each signal noise level is within the standard (L level: 0.2V_{dd} or less and H level: 0.8V_{dd} or more) even if the module has functioned properly. If it is beyond the standard, the module may often malfunction. In addition, always connect the module when making noise level measurements.
- 6) The CMOS ICs are incorporated in the module and the pull-up and pull-down function is not adopted for the input so avoid putting the input signal open while the power is ON.
- 7) The characteristic of the semiconductor element changes when it is exposed to light emissions, therefore ICs on the LCD may malfunction if they receive light emissions. To prevent these malfunctions, design and assemble ICs so that they are shielded from light emissions.
- 8) Crosstalk occurs because of characteristics of the LCD. In general, crosstalk occurs when the regularized display is maintained. Also, crosstalk is affected by the LC drive voltage. Design the contents of the display, considering crosstalk.

10.5 Other

- 1) Do not disassemble or take the LC module into pieces. The LC modules once disassembled or taken into pieces are not the guarantee articles.
- 2) The residual image may exist if the same display pattern is shown for hours. This residual image, however, disappears when another display pattern is shown or the drive is interrupted and left for a while. But this is not a problem on reliability.
- 3) AMIPRE will provide one year warranty for all products and three months warrantee for all repairing products.

