



晶采光電科技股份有限公司
AMPIRE CO., LTD.

Specifications for LCD module

Customer	
Customer part no.	
Ampire part no.	AM-800480BTMQW-B6H
Approved by	
Date	

Preliminary Specification



Approved Specification

AMPIRE CO., LTD.

4F., No.116, Sec. 1, Xintai 5th Rd., Xizhi Dist., New Taipei City 221, Taiwan (R.O.C.)

新北市汐止區新台五路一段 116 號 4 樓(東方科學園區 A 棟)

TEL:886-2-26967269 , FAX:886-2-26967196 or 26967270

Approved by	Checked by	Organized by
		

RECORD OF REVISION

Revision Date	Page	Contents	Editor
2016/6/8	-	New release	Jessica
2016/6/13	12	Update power supply current	Jessica
2016/6/14	7	Adjust color chromaticity	Jessica
2016/9/21	17-18	Update drawings	Jessica
2016/10/5	7	Add chromaticity	Jessica
2016/11/15	7	Correct color chromaticity	Jessica
2016/12/22	7	Update optical specifications	Jessica

1. Features

It's a 7 inches Amorphous-TFT-LCD (Thin Film Transistor Liquid Crystal Display) module. This module is composed of a 7" TFT-LCD panel, LED backlight.

- (1) Construction: 7" a-Si TFT active matrix, White LED Backlight.
- (2) Resolution (pixel): 800(R.G.B) X480
- (3) Number of the Colors : 262K colors (R , G , B 6 bit digital each)
- (4) LCD type : Transmissive, normally White
- (5) Interface: TTL
- (6) Viewing Direction: 6 o'clock (Gray inversion)

2. PHYSICAL SPECIFICATIONS

Item	Specifications	unit
LCD size	7 inch (Diagonal)	
Resolution	800 x (RGB) x 480	dot
Pixel pitch	0.192(W) x 0.1805(H)	mm
Active area	153.6(W) x 86.64(H)	mm
Module size	164.9(W) x 100(H) x 9.65(D)	mm
Color arrangement	RGB-stripe	
interface	Digital	

3. ABSOLUTE MAX. RATINGS

Item	Symbol	Values			Unit	Remark
		MIN	TYP	MAX		
Power Voltage	VCC	-0.5	--	5	V	
LED Driver Power Voltage	VLED	-0.3	--	19	V	
Operation Temperature	TOP	-20	-	70	°C	
Storage Temperature	TST	-30	-	80	°C	

Note (1) The absolute maximum rating values of this product are not allowed to be exceeded at any times. Should a module be used with any of the absolute maximum ratings exceeded, the characteristics of the module may not be recovered, or in an extreme case, the module may be permanently destroyed.

4. Backlight Driving Conditions

ITEM	SYMBOL	MIN	TYP	MAX	UNIT	NOTE
LED Driver Power Voltage	VLED	--	12	19	V	
LED Driver Power Current	ILED(VLED=12V)	--	330	--	mA	Ta=25°C
PWM Dimming DC active level	VDIMH	1.5	--	6	V	
	VDIML	--	--	0.6	V	
PWM Dimming Freq.	FDIM	0.2		20	kHz	
BLEN Pin High Voltage	VBLENH	1.4		--	V	
BLEN Pin Low Voltage	VBLENL	--		0.8	V	
LED voltage	VAK	--	26.4	--	V	Note 1
LED current	IF	--	120	--	mA	Note 1
LED life time	--	--	50	--	kHrs	Note 2

Note (1) The LED Supply Voltage is defined by the number of LED at Ta=25°C and IF=120 mA.

Note (2) The “LED life time” is defined as the module brightness decrease to 50% original brightness at Ta=25°C and IF=120mA. The LED lifetime could be decreased if operating IF is larger than 120mA.

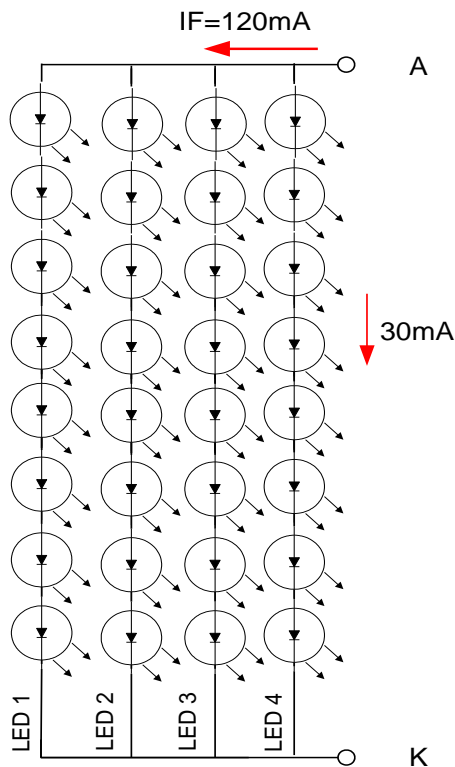

Note (3) When LCM is operated over 40°C ambient temperature, the IF should be follow :

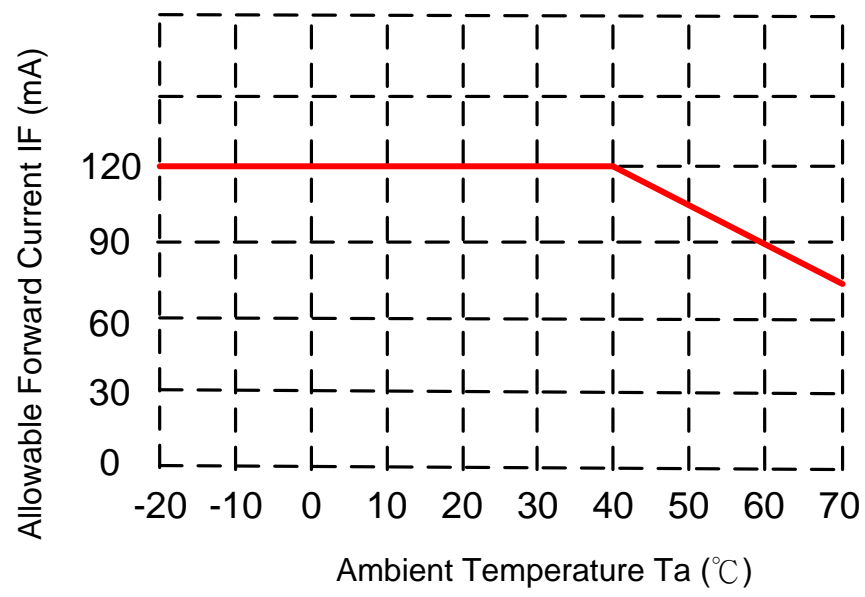

5. Optical Specifications

Item	Symbol	Condition	Values			Unit	Note
			Min.	Typ.	Max.		
Viewing angle (CR \geq 10)	θ L	$\Phi = 180^\circ$ (9 o'clock)	60	70	--	degree	Note1
	θ R	$\Phi = 0^\circ$ (3 o'clock)	60	70	--		
	θ T	$\Phi = 90^\circ$ (12 o'clock)	40	50	--		
	θ B	$\Phi = 270^\circ$ (6 o'clock)	50	60	--		
Response time	TON	Normal $\theta = \Phi = 0^\circ$	--	5	7	msec	Note3
	TOFF		--	20	28	msec	
Contrast ratio	CR		400	500	--	--	Note4
Color chromaticity	WX		0.26	0.31	0.36	--	Note5 Note6
	WY		0.32	0.37	0.42	--	
	RX		0.57	0.62	0.67		
	RY		0.31	0.36	0.41		
	GX		0.30	0.35	0.40		
	GY		0.55	0.60	0.65		
	BX		0.06	0.11	0.16		
	BY	0.07	0.12	0.17			
Luminance (central point)	L	800	1000	--	cd/m ²	Note6	
Luminance uniformity	YU	70	75	--	%	Note6	

Test Conditions:

VCC = 3.3V, IF = 120mA (Backlight current), the ambient temperature is 25°C.

The test systems refer to Note 2.

Note (1) Definition of viewing angle range

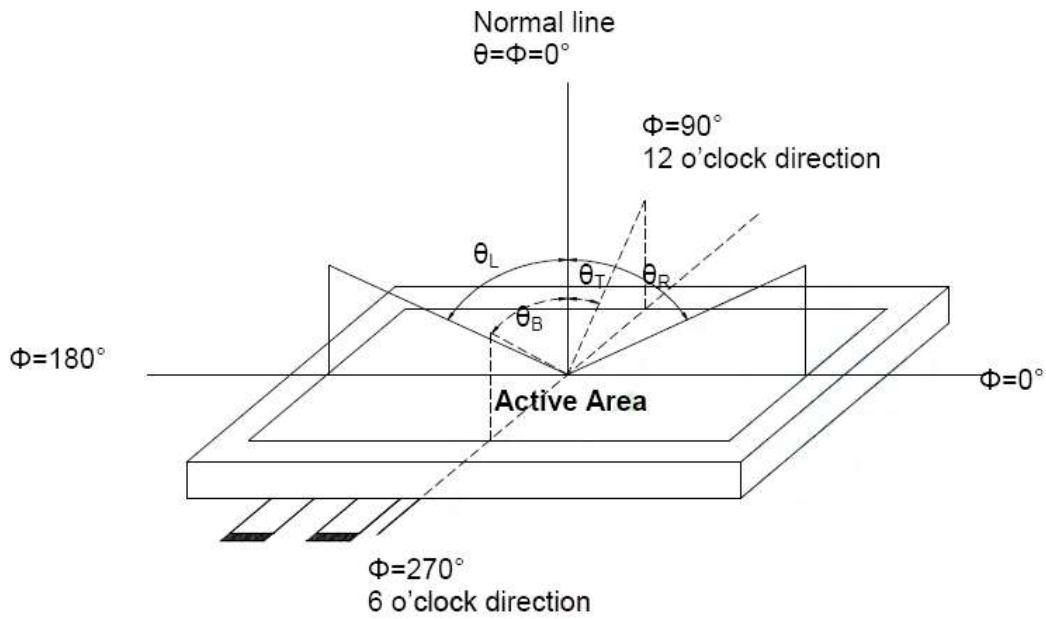

Note (2) Definition of optical measurement system

The optical characteristics should be measured in dark room. After 30 minutes operation, the optical properties are measured at the center point of the LCD screen. (Response time is measured by Photo detector TOPCON BM-7, other items are measured by BM-5A/Field of view: 1° / Height: 500mm.)

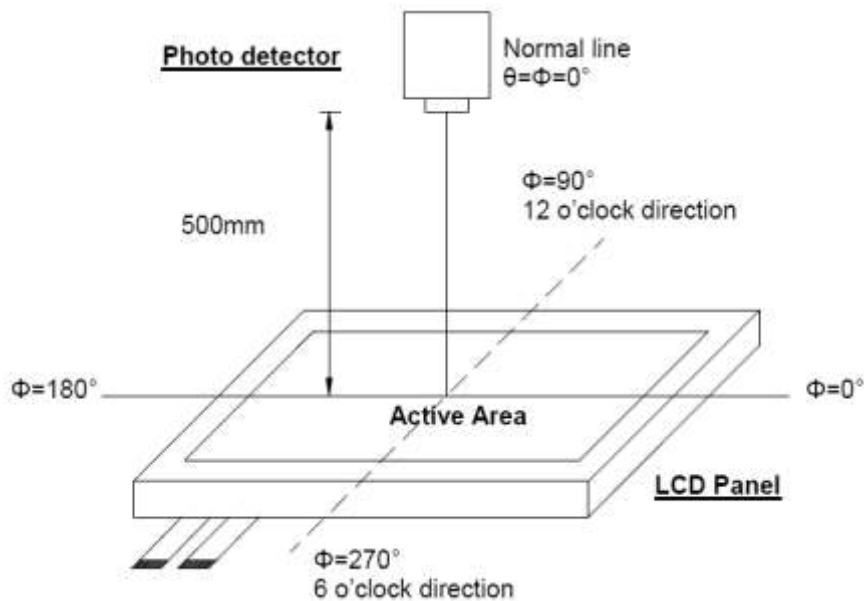

Note (3) Definition of Response time

The response time is defined as the LCD optical switching time interval between “White” state and “Black” state. Rise time (TON) is the time between photo detector output intensity changed from 90% to 10%. And fall time (TOFF) is the time between photo detector output intensity changed from 10% to 90%.

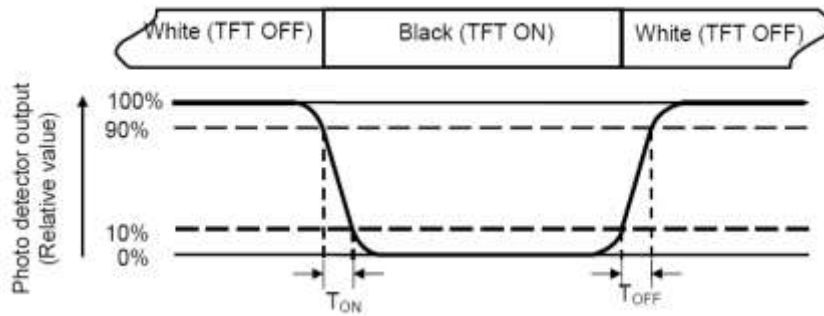

Note (4) Definition of contrast ratio

$$\text{Contrast ratio (CR)} = \frac{\text{Luminance measured when LCD on the "White" state}}{\text{Luminance measured when LCD on the "Black" state}}$$

Note (5) Definition of color chromaticity (CIE1931)

Color coordinated measured at center point of LCD.

All input terminals LCD panel must be ground when measuring the center area of the panel.

Note (6) Definition of Luminance Uniformity

Active area is divided into 9 measuring areas (Refer to bellow figure).

Every measuring point is placed at the center of each measuring area.

$$\text{Luminance Uniformity (Yu)} = \frac{B_{\min}}{B_{\max}}$$

L ----- Active area length W ----- Active area width

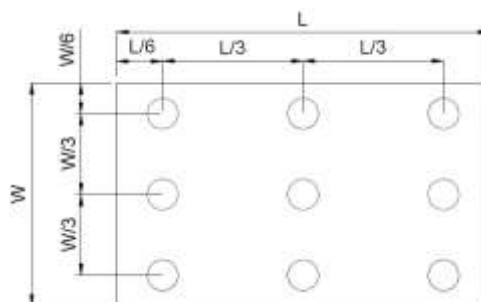

Bmax : The measured maximum luminance of all measurement position.

Bmin : The measured minimum luminance of all measurement position.

6. INTERFACE

Pin No.	Symbol	Function
1	LGND	LED Driver Ground
2	LGND	LED Driver Ground
3	ADJ	Adjust for LED Brightness
4	VLED	Power supply for LED
5	VLED	Power supply for LED
6	VLED	Power supply for LED
7	VCC	Power supply for LCD
8	VCC	Power supply for LCD
9	DE	Data Enable Timing Signal
10	GND	Ground
11	GND	Ground
12	GND	Ground
13	B5	Blue data (MSB)
14	B4	Blue data
15	B3	Blue data
16	GND	Ground
17	B2	Blue data
18	B1	Blue data
19	B0	Blue data (LSB)
20	GND	Ground
21	G5	Green data (MSB)
22	G4	Green data
23	G3	Green data
24	GND	Ground
25	G2	Green data
26	G1	Green data
27	G0	Green data (LSB)
28	GND	Ground
29	R5	Red data (MSB)
30	R4	Red data
31	R3	Red data
32	GND	Ground

33	R2	Red data
34	R1	Red data
35	R0	Red data (LSB)
36	GND	Ground
37	GND	Ground
38	DCLK	Data Clock
39	GND	Ground
40	GND	Ground

I: input, O: output, P: power

7. ELECTRICAL CHARACTERISTICS

7.1 DC Characteristics

Item	Symbol	Min.	Typ.	Max.	Unit	Remark
Power supply	VCC	3.0	3.3	3.6	V	
LED Driver Power Supply	VLED	--	12	19	--	
Input Voltage for logic	H Level	V _{IH}	0.7 VCC	--	VCC	V
	L Level	V _{IL}	0	--	0.3 VCC	V
Power Supply current	ICC		85		mA	Note1
LED Power Supply current VLED=12V	ILED	--	330	--	mA	Ta=25°C

Note (1) TFT power supply current. VCC=3.0V, fV =60Hz, Ta=25°C, Display pattern: All Black

7.2 AC Characteristics

TTL

- Horizontal timing

Parameter	Symbol	Spec			Unit
		Min.	Typ.	Max.	
H-Display Area	thd		800		DCLK
DCLK Frequency	fclk	--	30	50	MHz
One Horization Period	th	862	1056	1200	DCLK
HS Pulse Width	thpw	1	--	40	DCLK
HS Back Porch (Blanking)	thb		46		DCLK
HS Front Porch	thfp	16	210	354	DCLK
DE Mode Blanking	th-thd	85	256	400	DCLK

- Vertical timing

Parameter	Symbol	Spec			Unit
		Min.	Typ.	MAX	
V-Display Area	tvd		480		th
VS period Time	Tv	513	525	650	th
VS pulse width	tvpw	3	--	20	th
VS Back Porch (Blanking)	tvb		23		th
VS Front Porch	tvfp	7	22	147	th
DE Mode Blanking	tv-tvd	30	45	170	th

Horizontal Input Timing

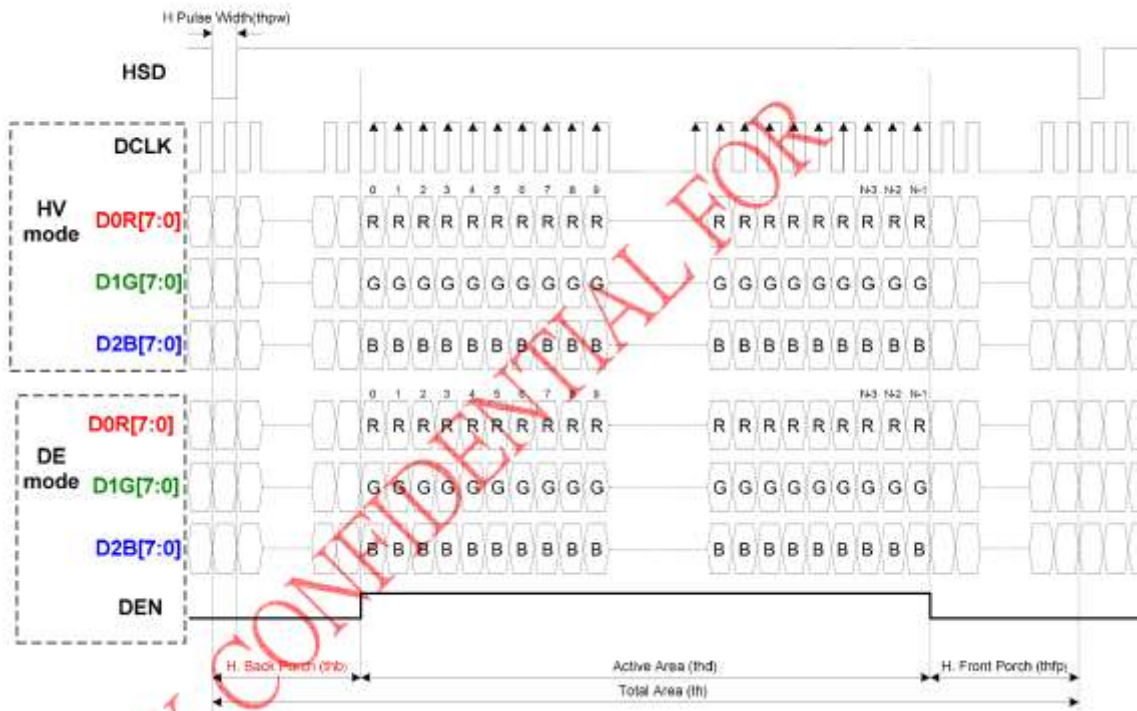

Vertical Input Timing

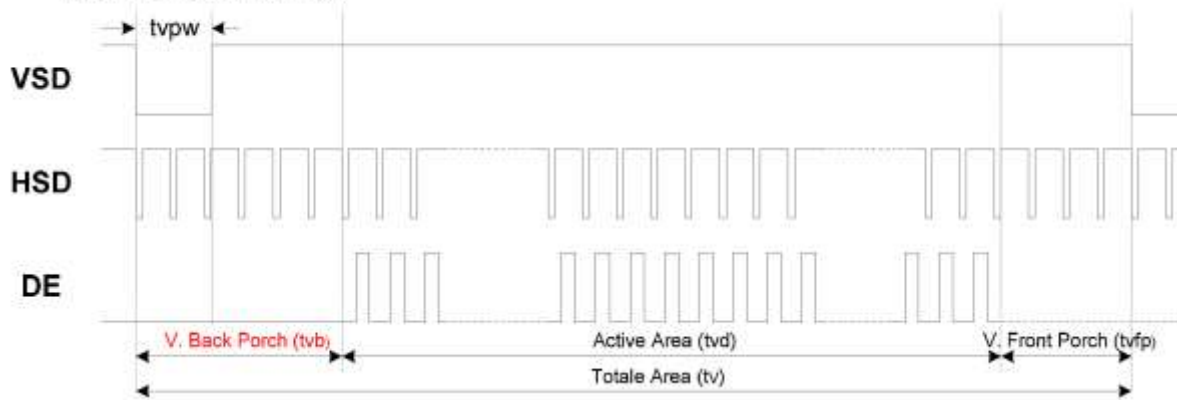

7.3 Power ON/OFF sequence

VCC power and LED on/off sequence are as follows. Interface signals are also shown in the chart. Signal shall be Hi-Z state or low level when VCC is off.

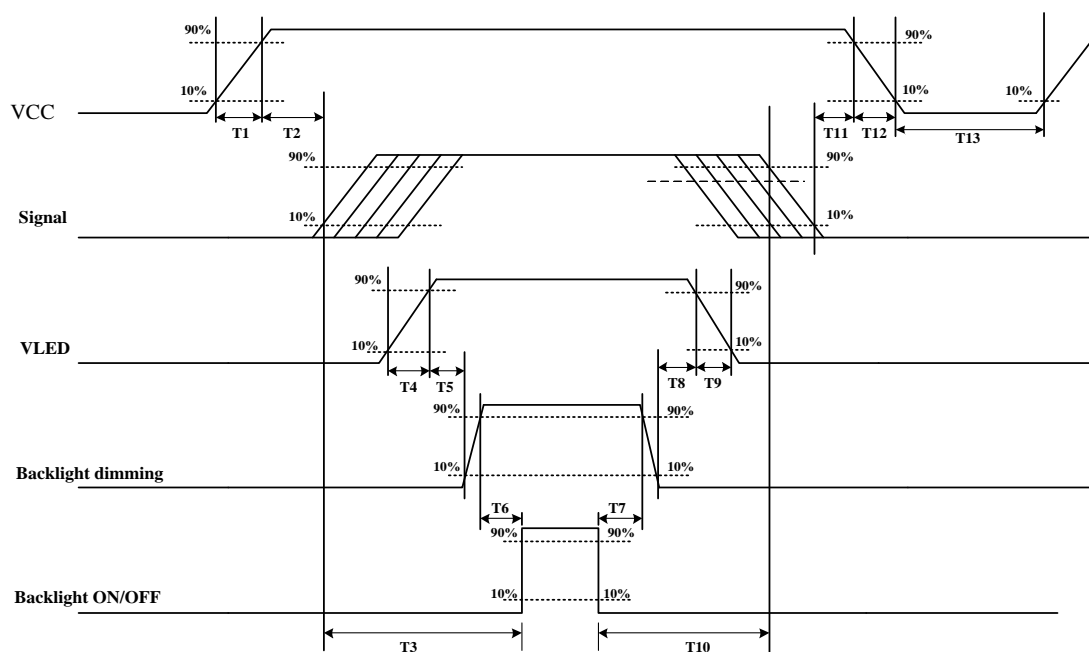

Parameter	Value			Units
	Min.	Typ.	Max.	
T1	0.5	-	10	[ms]
T2	0	40	50	[ms]
T3	200	-	-	[ms]
T4	0.5	-	10	[ms]
T5	10	-	-	[ms]
T6	10	-	-	[ms]
T7	0	-	-	[ms]
T8	10	-	-	[ms]
T9	-	-	10	[ms]
T10	110	-	-	[ms]
T11	0.5	16	50	[ms]
T12	-	-	100	[ms]
T13	1000	-	-	[ms]

8. RELIABILITY TEST CONDITIONS

Test Item	Test Conditions	Note
High Temperature Operation	70±3°C , t=240 hrs	
Low Temperature Operation	-20±3°C , t=240 hrs	
High Temperature Storage	80±3°C , t=240 hrs	1,2
Low Temperature Storage	-30±3°C , t=240 hrs	1,2
Storage at High Temperature and Humidity	60°C, 90% RH , 240 hrs	1,2

Note (1) Condensation of water is not permitted on the module.

Note (2) The module should be inspected after 1 hour storage in normal conditions (15-35°C, 45-65%RH).

9. General Precautions

9.1 Safety

- (1) Liquid crystal is poisonous. Do not put it your month. If the liquid crystal touches you skin or clothes, you need to wash it off immediately with the soap and water.

9.2 Handling

- (1) The LCD panel is plate glass. Do not subject the panel to mechanical shock or excessive force on its surface.
- (2) The polarizer which attached to the display is easily damaged. Please handle it carefully to avoid scratch or other damages.
- (3) To avoid contamination on the display surface, do not touch the module surface with bare hands.
- (4) Keep a space so that the LCD panels do not touch other components.
- (5) Put on cover board such as acrylic board, which covers on the surface of LCD panel to protect panel from damages.
- (6) Transparent electrodes may be disconnected if you use the LCD panel under environmental conditions where the condensation of dew occurs.
- (7) Do not leave module in direct sunlight to avoid malfunction of the ICs.

9.3 Static Electricity

- (1) Be sure to ground module before you turn on power or operation module.
- (2) Do not apply voltage which exceeds the absolute maximum rating value.

9.4 Storage

- (1) Store the module in a dark room where it must keep at $+25\pm 10^{\circ}\text{C}$ and 65%RH or less.
- (2) Do not store the module in surroundings which are containing organic solvent or corrosive gas.
- (3) Store the module in an anti-electrostatic container or bag.

9.5 Cleaning

- (1) Do not wipe the polarizer with dry cloth. It might cause scratch.
- (2) Only use a soft sloth with IPA to wipe the polarizer, other chemicals might permanent damage to the polarizer.

9.6 Others

- (1) AMIPRE will provide one year warrantee for all products and three months warrantee for all repairing products.
- (2) Do not apply fixed pattern data signal to the LCD module as you are using the product.

10. OUTLINE DIMENSION

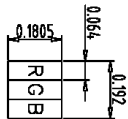

A Block

1	LGND	21	G5
2	LGND	22	G4
3	ADU	23	G3
4	VLED	24	GND
5	VLED	25	G2
6	VLED	26	G1
7	VCC	27	G0
8	VCC	28	GND
9	DE	29	R5
10	GND	30	R4
11	GND	31	R3
12	GND	32	GND
13	B5	33	R2
14	B4	34	R1
15	B3	35	R0
16	GND	36	GND
17	B2	37	GND
18	B1	38	CLK
19	B0	39	GND
20	GND	40	GND

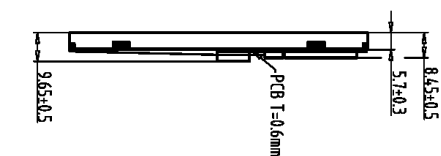
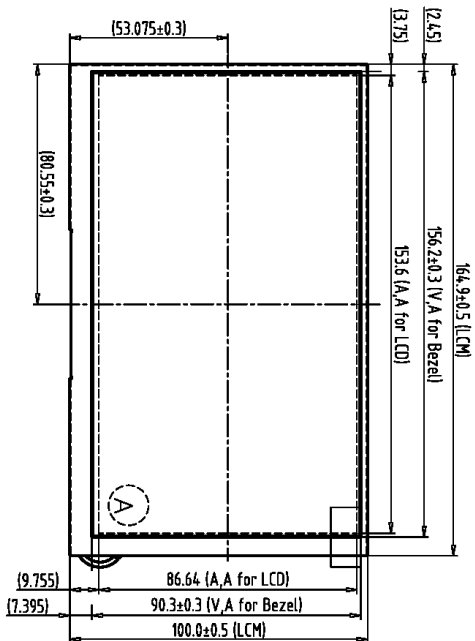

Note:

1. Unless indicated, Tolerance "±0.3"
2. UV Glue For OLB Protection.
3. CN2:P0.5 40Pin H2.0/089H40-000000-G2-C or Equivalent
4. CN1:P0.5 50Pin/CSF-2082-501R or Equivalent.
5. LCD 800X3(R,G,B)x480=> 7.0" Digital TFT LCD

1	6.95 TFT LCD 800X480	7		TOLERANCE GRAD(E)	A	B	DIM.	MM	DWG.	EMILY	DATE	08-12-16
2	New PCB (TTL)	8					IP NO.		CHK.		DATE	
3	New B/L (LCM 1000nits)	9					PARTS NO. LCM	800480B-B6	APPD.		DATE	
4	New Bezel	10									DATE	
5		11									DATE	
6		12									DATE	



TITLE
800480B-B6

DWG. NO. *160851MA
SHEET 1 OF 1

REV	REVISION RECORD	DATE	NAME
0	NEW RELEASE	08-01	EMILY

REV	REVISION RECORD	DATE	NAME
0	NEW RELEASE	08-27-08	EMILY

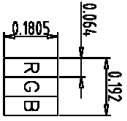

A Block

1	L GND	21	G5
2	L GND	22	G4
3	ADU	23	G3
4	VLED	24	GND
5	VLED	25	G2
6	VLED	26	G1
7	VCC	27	G0
8	VCC	28	GND
9	DE	29	R5
10	GND	30	R4
11	GND	31	R3
12	GND	32	GND
13	B5	33	R2
14	B4	34	R1
15	B3	35	RO
16	GND	36	GND
17	B2	37	GND
18	B1	38	CLK
19	B0	39	GND
20	GND	40	GND

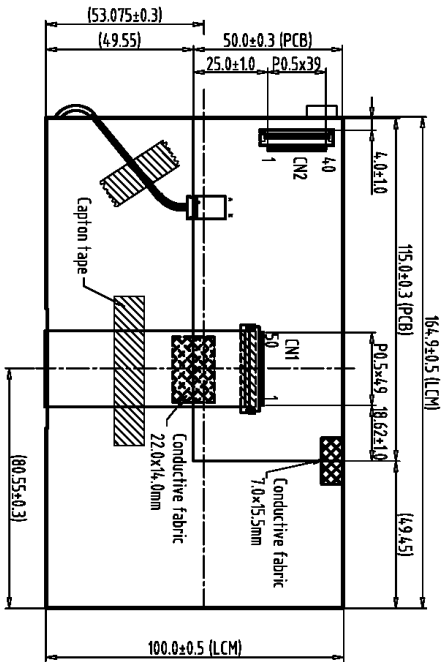

Back View

Note:

1. Unless indicated, Tolerance "±0.3"
2. UV Glue For OLB Protection.
3. CN2:P0.5 40Pin H2.0/089H40-000000-G2-C or Equivalent
4. CN1:P0.5 50Pin/CSF-2082-501R or Equivalent.
5. LCD 800X3(R,G,B)x480=> 7.0" Digital TFT LCD

1	6.95	TFT LCD	800X480	7		TOLERANCE GRAD(E)	A	B	DIM.	MM	DWN.	EMILY	DATE	08-12-16
2	New PCB	(TTL)		8					IF NO.		CHK.		DATE	
3	New B/L	(LCM 1000nits)		9					PARTS NO.	LCM-1	APPD.		DATE	
4	New Bezel			10					800480B-86				DATE	
5				11									DATE	
6				12									DATE	

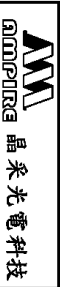

TITLE
800480B-B6

DWG. NO. *160852MA
SHEET 1 OF 1