



晶采光電科技股份有限公司  
AMPIRE CO., LTD.

## SPECIFICATIONS FOR LCD MODULE

<b>CUSTOMER</b>	
<b>CUSTOMER PART NO.</b>	
<b>AMPIRE PART NO.</b>	<b>AM-800480ANTMQW-A0H</b>
<b>APPROVED BY</b>	
<b>DATE</b>	

- Approved For Specifications  
 Approved For Specifications & Sample

**AMPIRE CO., LTD.**  
**4F., No.116, Sec. 1, Xintai 5th Rd., Xizhi Dist., New Taipei**  
**City221, Taiwan (R.O.C.)**  
**新北市汐止區新台五路一段 116 號 4 樓(東方科學園區 A 棟)**

APPROVED BY	CHECKED BY	ORGANIZED BY

## RECORD OF REVISION

Revision Date	Page	Contents	Editor
2014/7/11		New Release	Kokai
2014/10/6		Modify LED driver Data according the real design.	Kokai

AMPIRE CONFIDENTIAL

## 1. Features

9 inch Amorphous-TFT-LCD (Thin Film Transistor Liquid Crystal Display) module.  
This module is composed of a 8" TFT-LCD panel and LED backlight.

- (1) Construction: 9" a-Si TFT active matrix, White LED Backlight.
- (2) Resolution (pixel): 800(R.G.B) X480
- (3) Number of the Colors : 16M colors ( R , G , B 8 bit digital each)
- (4) LCD type : Transmissive, normally White
- (5) Interface:LVDS interface 20 pin**
- (6) Built-in LED Driver. (PWM Dimming).**
- (7) Power Supply Voltage: 3.3V for logic voltage.
- (8) Viewing Direction: 6 O'clock (Gray Inversion The direction it's hard to be discolored)

## 2. PHYSICAL SPECIFICATIONS

Item	Specifications	unit
LCD size	9 inch (Diagonal)	
Resolution	800 x (RGB) x 480	dot
Dot pitch	0.0825(W) x 0.2327(H)	mm
Active area	198.0(W) x 111.696(H)	mm
Module size	211.1(W) x 126.5(H) x 10.85(D)	mm
Surface treatment	Anti-Glare	
Color arrangement	RGB-stripe	
interface	LVDS	
Weight	T.B.D (typ.)	g

### 3. ABSOLUTE MAX. RATINGS

Item	Symbol	Values		UNIT	Note
		Min.	Max.		
LED Power Supply Voltage	V <sub>LED</sub>	-0.3	13.0	V	GND=0
Logic Supply Voltage	V <sub>DD</sub>	-0.3	5.0	V	
Operation temperature	T <sub>OP</sub>	-20	70	°C	
Storage temperature	T <sub>ST</sub>	-30	80	°C	

Note 1: The product is subject to be damaged permanently if stresses beyond those absolute maximum ratings listed above.

## 4. ELECTRICAL CHARACTERISTICS

### 4-1 Typical Operation Conditions

Item	Symbol	Values			UNIT	Note
		Min.	Typ.	Max.		
Power voltage	VCC	3.0	3.3	3.6	V	Note1
Current of power supply	ICC	-	0.3	-	A	VDD=3.3V Black pattern
Power voltage for LED driver	VLED	10	12	15	V	
LED driver current of power supply	ILED	-	380	--	mA	VLED=12 ADJ=100%
LED Driver PWM dimming voltage	ADJ	1.4		5	VPP	Note 2
LED Driver PWM dimming frequency	F <sub>ADJ</sub>	100	300	1000	Hz	Note2

Note 1: VCC-dip condition :

when  $2.7V \leq VCC < 3.0V$  ,  $t_d \leq 10ms$ .

$VCC > 3.0V$  , VCC-dip condition should be same as VCC-turn-con condition.

Note 2 : PWM dimming : ADJ signal V<sub>p-p</sub> = 1.4~5.0V, operation frequency: 100Hz ~ 1 kHz

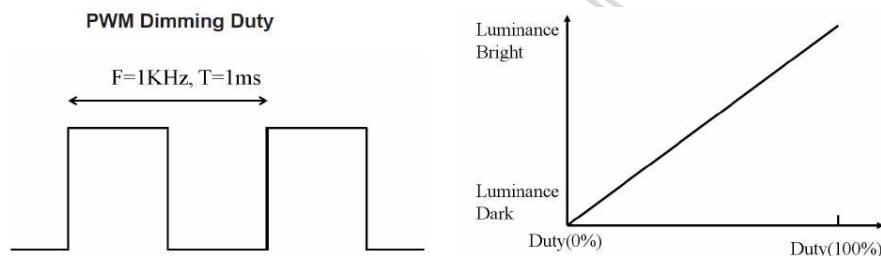

### 4.2 Switching Characteristics of LVDS Receiver

Item	Symbol	Min.	Typ.	Max.	Unit	Condition
Differential Input High Threshold	VTH	--	--	100	mV	VCM=1.2V
Differential Input Low Threshold	VTL	-100	--	--	mV	
Input current	IIN	-10	--	+10	uA	
Differential input Voltage	VID	0.2	--	0.6	V	
Common Mode Voltage Offset	VCM	$\frac{ VID }{2}$	1.25	$2.4 \cdot \frac{ VID }{2}$	V	

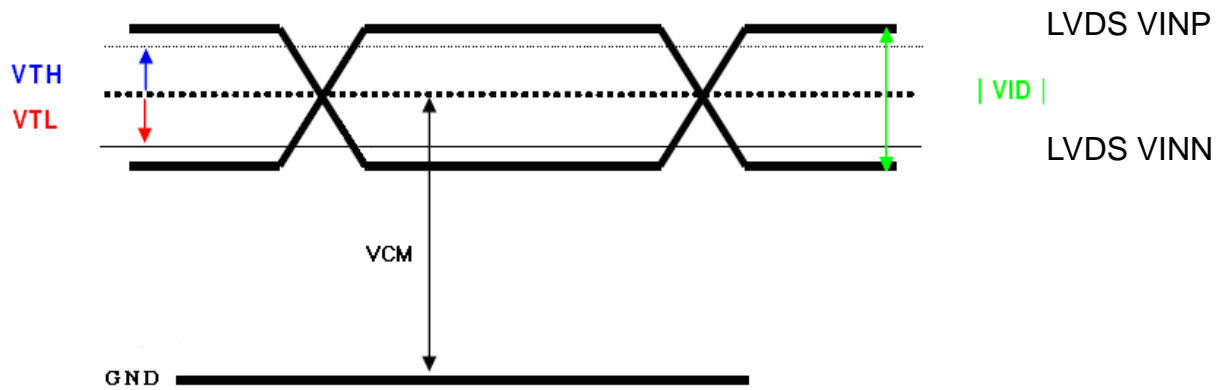

### 4-3 Backlight Driving Conditions

(For reference only, The module is built-in LED driver. The LED driver output current is setting to 170mA for optimum the power consumption, brightness and LED lifetime)

Item	Symbol	Values			Unit	Note
		Min.	Typ.	Max.		
LED voltage	VAK	--	25.2	--	LED voltage	VAK
LED current	IL	--	260	--	LED current	IL
LED life time	--	30,000	40,000	--	LED life time	--

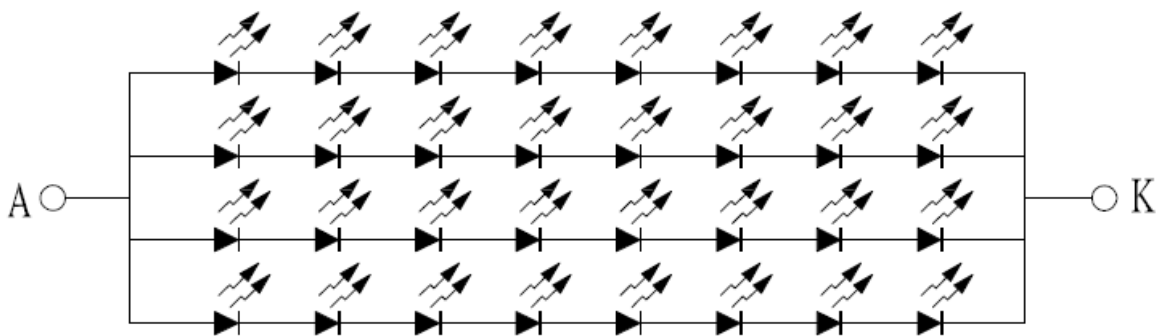

Note 1 : The LED Supply Voltage is defined by the number of LED at  $T_a=25^\circ\text{C}$  and  $I_L=260\text{mA}$ .

Note 2 : The "LED life time" is defined as the module brightness decrease to 50% original brightness at  $T_a=25^\circ\text{C}$  and  $I_L=260\text{mA}$ . The LED lifetime

could be decreased if operating IL is larger than 260mA.

Note 3 : When LCM is operated over 40°C ambient temperature, the IL should be follow :

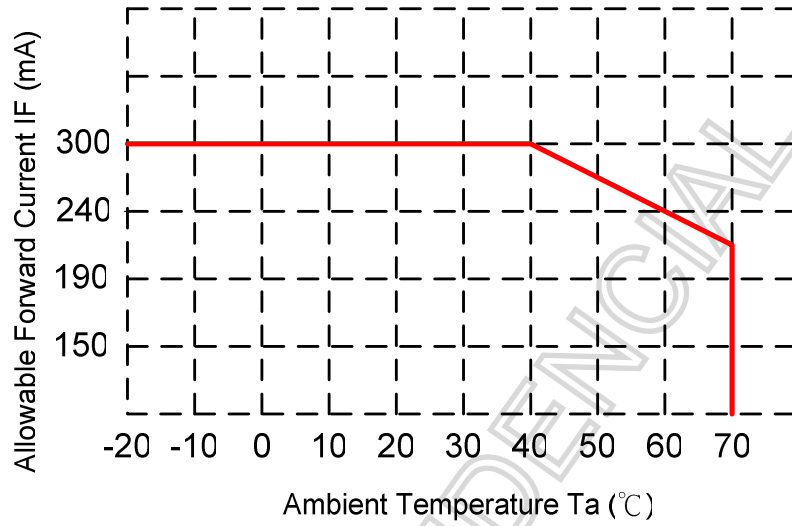

#### 4-4 Power Sequence

##### 4-4-1 Power on sequence

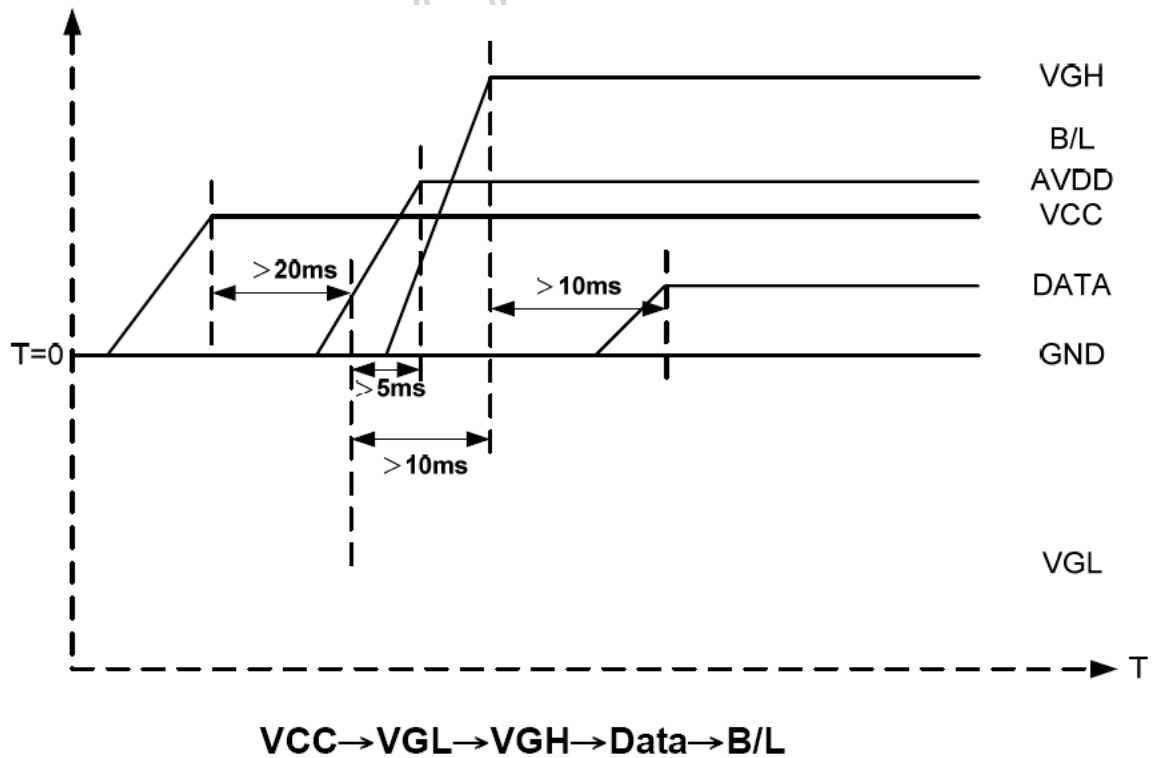

Note : Data Signal includes DCLK, DE, HS, VS, R0~R5, G0~G5, B0~B5.

#### 4-4-2 Power off sequence

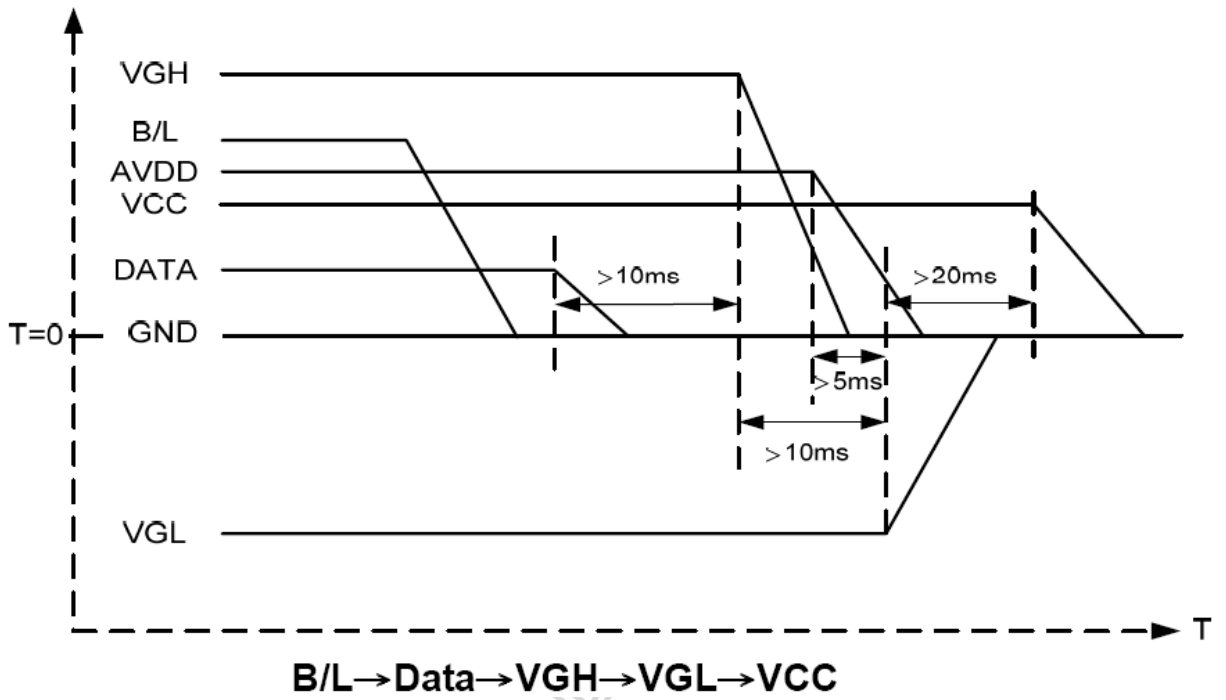

Note : Data Signal includes DCLK, DE, HS, VS, R0~R5, G0~G5, B0~B5.



## 5. Optical Specifications

Item	Symbol	Condition	Values			Unit	Note
			Min.	Typ.	Max.		
Viewing angle (CR $\geq$ 10)	$\theta$ L	$\Phi = 180^\circ$ (9 o'clock)	60	70	--	degree	Note1
	$\theta$ R	$\Phi = 0^\circ$ (3 o'clock)	60	70	--		
	$\theta$ T	$\Phi = 90^\circ$ (12 o'clock)	40	50	--		
	$\theta$ B	$\Phi = 270^\circ$ (6 o'clock)	60	70	--		
Response time	TON	Normal $\theta = \Phi = 0^\circ$	--	10	20	msec	Note3
	TOFF		--	15	30	msec	
Contrast ratio	CR		400	500	--	--	Note4
Color chromaticity	WX		0.26	0.31	0.36	--	Note5
	WY		0.28	0.33	0.38	--	Note6
Luminance	L		<b>800</b>	<b>1000</b>	--	cd/m <sup>2</sup>	Note6
Luminance uniformity	YU		70	75	--	%	Note7

Test Conditions :

1. ADJ PWM Duty=100% , IL = 260mA (Backlight current), the ambient temperature is 25°C .
2. The test systems refer to Note 2.

Note 1 : Definition of viewing angle range

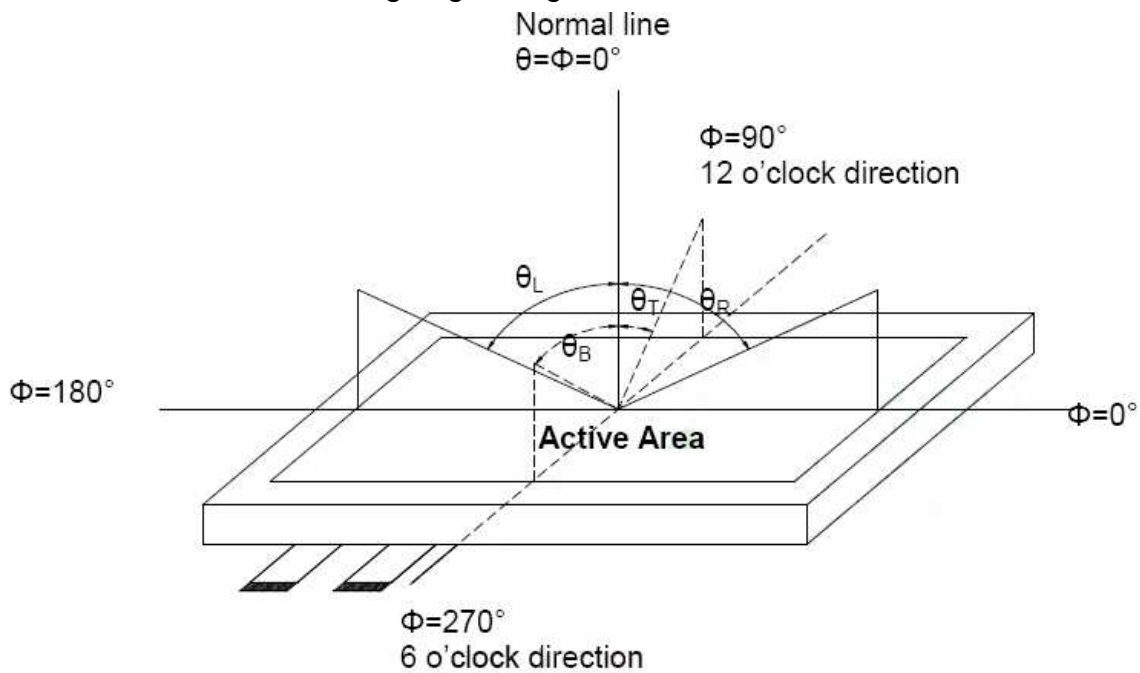

Note 2 : Definition of optical measurement system.

The optical characteristics should be measured in dark room. After 30 minutes operation, the optical properties are measured at the center point of the LCD screen. (Response time is measured by Photo detector TOPCON BM-7, other items are measured by BM-5A/Field of view :  $1^\circ$  / Height : 500 mm.)

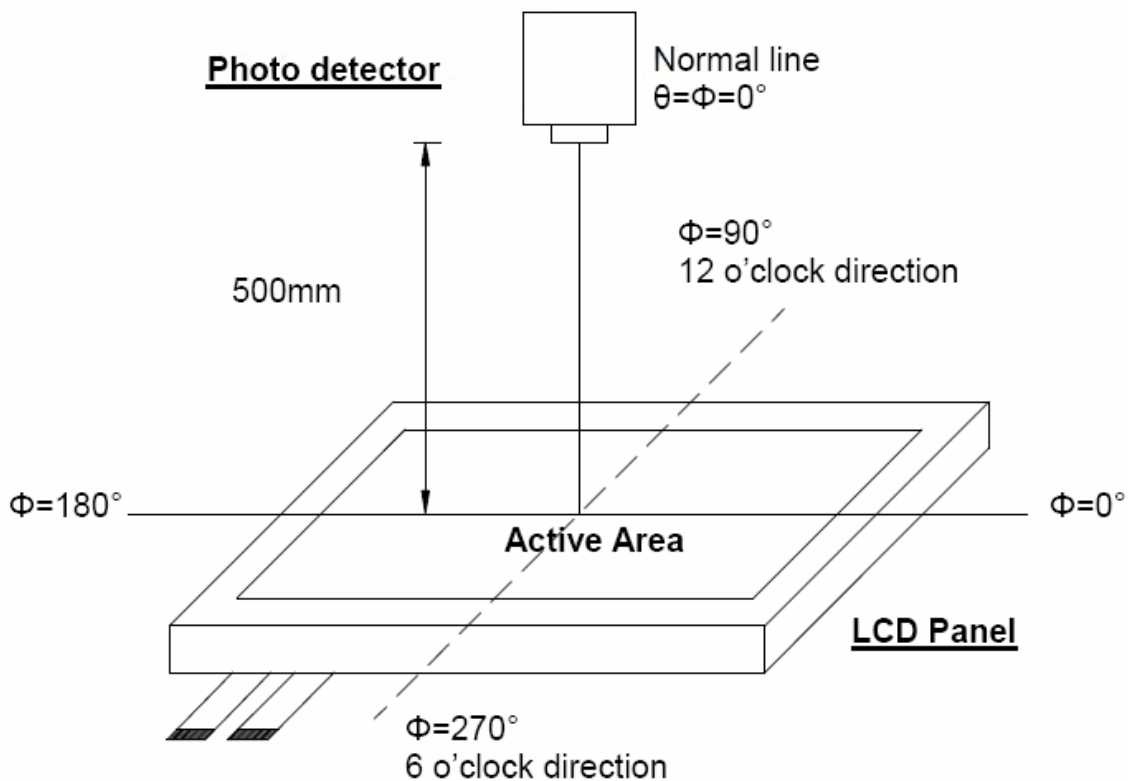

Note 3 : Definition of Response time

The response time is defined as the LCD optical switching time interval between “White” state and “Black” state. Rise time ( $T_{ON}$ ) is the time between photo detector output intensity changed from 90% to 10%. And fall time ( $T_{OFF}$ ) is the time between photo detector output intensity changed from 10% to 90%.

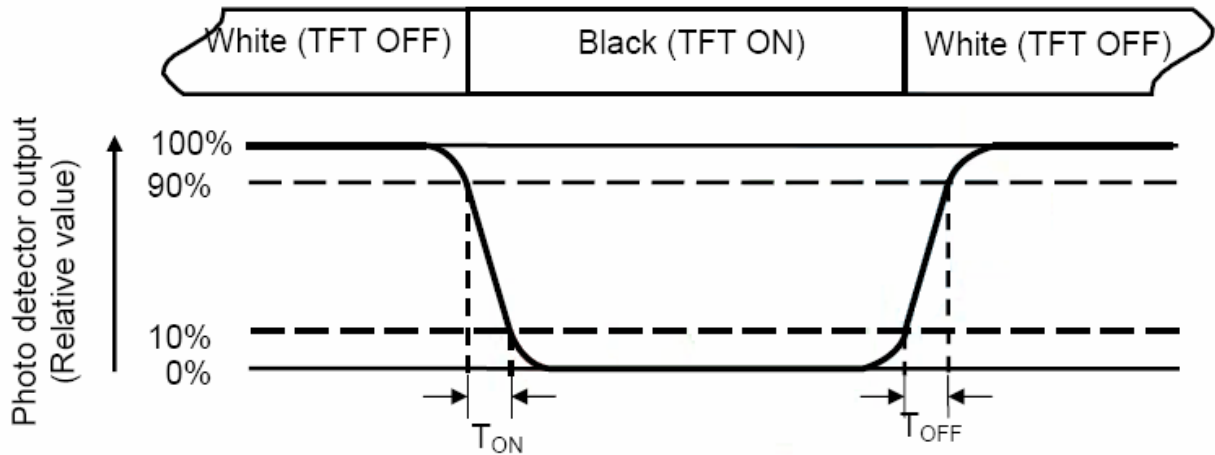

Note 4 : Definition of contrast ratio

$$\text{Contrast ratio (CR)} = \frac{\text{Luminance measured when LCD on the "White" state}}{\text{Luminance measured when LCD on the "Black" state}}$$

Note 5 : Definition of color chromaticity (CIE1931)

Color coordinated measured at center point of LCD.

Note 6 : All input terminals LCD panel must be ground when measuring the center area of the panel.

Note 7 : Definition of Luminance Uniformity

Active area is divided into 9 measuring areas (Refer to bellow figure). Every measuring point is placed at the center of each measuring area.

$$\text{Luminance Uniformity (Yu)} = \frac{B_{\min}}{B_{\max}}$$

L ----- Active area length      W ----- Active area width

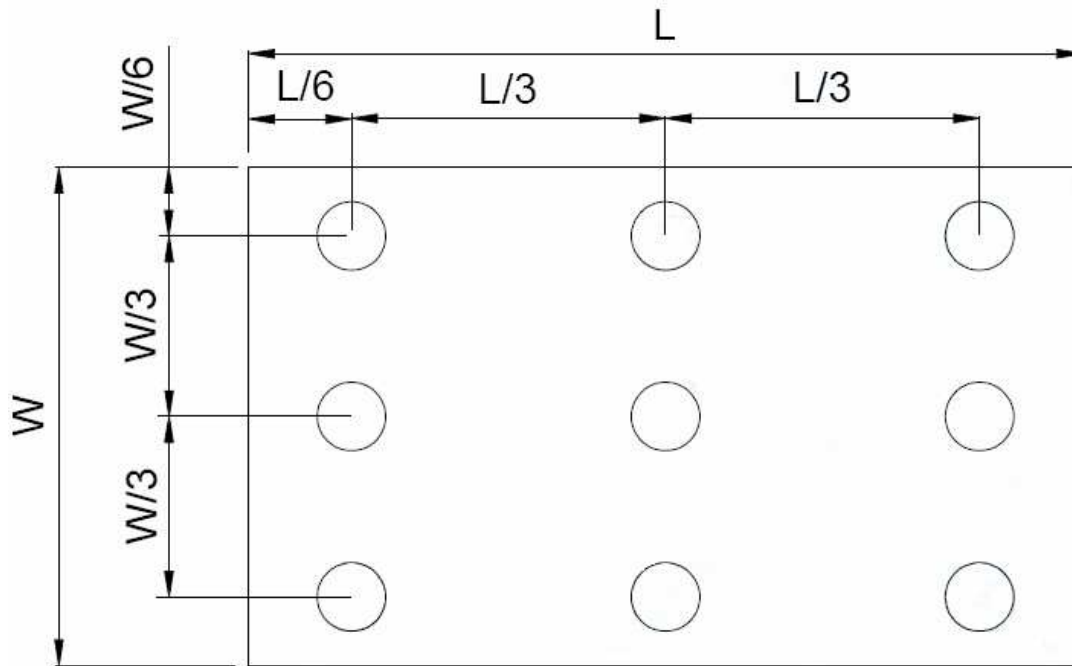

$B_{\max}$  : The measured maximum luminance of all measurement position.

$B_{\min}$  : The measured minimum luminance of all measurement position.

## 6. INTERFACE

### TFT LCD Panel Driving Section

Pin No.	Symbol	Description	Note
1	VCC	3.3V Power	
2	VCC	3.3V Power	
3	GND	Ground	
4	GND	Ground	
5	RXIN0-	LVDS Signal - channel0-	
6	RXIN0+	LVDS Signal+ channel0+	
7	GND	Ground	
8	RXIN1-	Data Input channel1-	
9	RXIN1+	Data Input channel1+	
10	GND	Ground	
11	RXIN2-	Data Input channel2-	
12	RXIN2+	Data Input channel2+	
13	GND	Ground	
14	RXCLKIN-	Data Input CLK-	
15	RXCLKIN+	Data Input CLK+	
16	GND	Ground	
17	VLED	LED Driver Power Supply	
18	VLED	LED Driver Power Supply	
19	GND	Ground	
20	ADJ	PWM Adjust for LED brightness	

## 7. INPUT SIGNAL :

### 7-1 AC Electrical Characteristics

Item	Symbol	Value			Unit	Remark
		Min.	Typ.	Max.		
HS setup time	Thst	8	-	-	ns	
HS hold time	Thhd	8	-	-	ns	
VS setup time	Tvst	8	-	-	ns	
VS hold time	Tvhd	8	-	-	ns	
Data setup time	Tdsu	8	-	-	ns	
Data hole time	Tdhd	8	-	-	ns	
DE setup time	Tesu	8	-	-	ns	
DE hold time	Tehd	8	-	-	ns	
DVDD Power On Slew rate	TPOR	-	-	20	ms	From 0%~90%
RESET pulse width	TRST	1	-	-	ms	
DCLK cycle time	Tcoh	20	-	-	ns	
DCLK pulse duty	Tcwh	40	50	60	%	

### 7-2 Timing

Item	Symbol	Value			Unit	Remark
		Min.	Typ.	Max.		
Horizontal Display Area	Thd	-	800	-	DCLK	
DCLK Frequency	fclk	26.4	33.3	46.8	MHz	
One Horizontal Line	th	862	1056	1200	DCLK	
HS pulse width	thpw	1	-	40	DCLK	
HS Blanking	Thb	46	46	46	DCLK	
HS Front Porch	Thfp	16	210	354	DCLK	

Item	Symbol	Value			Unit	Remark
		Min.	Typ.	Max.		
Vertical Display Area	Thd	-	480	-	TH	
VS period time	Tv	510	525	650	TH	
VS pulse width	tvpw	1	-	20	TH	
VS Blanking	Tvb	23	23	23	TH	
VS Front Porch	Tvfp	7	22	147	TH	

### 7-3 Input Clock and Data Timing Diagram

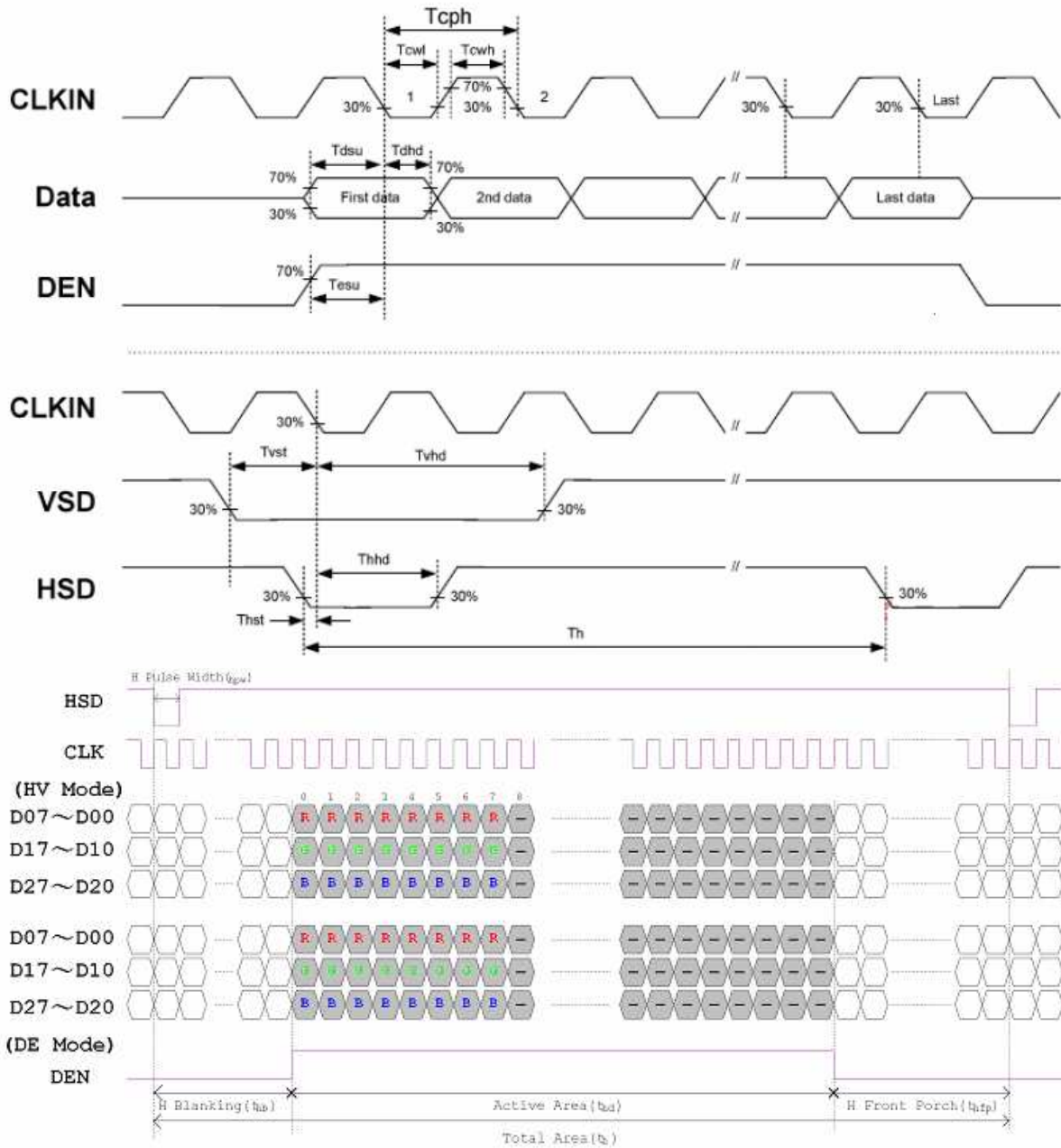

## 8. RELIABILITY TEST CONDITIONS

Test Item	Test Conditions	Note
High Temperature Operation	70±3°C , t=240 hrs	
Low Temperature Operation	-20±3°C , t=240 hrs	
High Temperature Storage	80±3°C , t=240 hrs	1,2
Low Temperature Storage	-30±3°C , t=240 hrs	1,2
Thermal Shock Test	-20°C ~ 25°C ~ 70°C 30 m in. 5 min. 30 min. ( 1 cycle ) Total 5 cycle	1,2
Humidity Test	40 °C, Humidity 90%, 96 hrs	1,2
Vibration Test (Packing)	Sweep frequency : 10 ~ 55 ~ 10 Hz/1min Amplitude : 0.75mm Test direction : X.Y.Z/3 axis Duration : 30min/each axis	2

Note 1 : Condensation of water is not permitted on the module.

Note 2 : The module should be inspected after 1 hour storage in normal conditions

(15-35°C , 45-65%RH).

Definitions of life end point :

- Current drain should be smaller than the specific value.
- Function of the module should be maintained.
- Appearance and display quality should not have degraded noticeably.
- Contrast ratio should be greater than 50% of the initial value.



## 9. General Precautions

### 9-1 Safety

Liquid crystal is poisonous. Do not put it your mouth. If liquid crystal touches your skin or clothes, wash it off immediately by using soap and water.

### 9-2 Handling

1. The LCD panel is plate glass. Do not subject the panel to mechanical shock or to excessive force on its surface.
2. The polarizer attached to the display is easily damaged. Please handle it carefully to avoid scratch or other damages.
3. To avoid contamination on the display surface, do not touch the module surface with bare hands.
4. Keep a space so that the LCD panels do not touch other components.
5. Put cover board such as acrylic board on the surface of LCD panel to protect panel from damages.
6. Transparent electrodes may be disconnected if you use the LCD panel under environmental conditions where the condensation of dew occurs.
7. Do not leave module in direct sunlight to avoid malfunction of the ICs.

### 9-3 Static Electricity

1. Be sure to ground module before turning on power or operation module.
2. Do not apply voltage which exceeds the absolute maximum rating value.

### 9-4 Storage

1. Store the module in a dark room where must keep at  $+25\pm 10^{\circ}\text{C}$  and 65%RH or less.
2. Do not store the module in surroundings containing organic solvent or corrosive gas.
3. Store the module in an anti-electrostatic container or bag.

### 9-5 Cleaning

1. Do not wipe the polarizer with dry cloth. It might cause scratch.
2. Only use a soft sloth with IPA to wipe the polarizer, other chemicals might permanent damage to the polarizer.

### 9-5 Others

1. AMIPRE will provide one year warrantee for all products and three months warrantee for all repairing products.

# 10. OUTLINE DIMENSION

