



晶采光電科技股份有限公司
AMPIRE CO., LTD.

SPECIFICATIONS FOR LCD MODULE

CUSTOMER	
CUSTOMER PART NO.	
AMPIRE PART NO.	AM-640480GBTNQW-02H
APPROVED BY	
DATE	

- Approved For Specifications
 Approved For Specifications & Sample

AMPIRE CO., LTD.

**4F., No.116, Sec. 1, Xintai 5th Rd., Xizhi Dist., New Taipei
City221, Taiwan (R.O.C.)**

新北市汐止區新台五路一段 116 號 4 樓(東方科學園區 A 棟)

TEL:886-2-26967269 , FAX:886-2-26967196 or 26967270

APPROVED BY	CHECKED BY	ORGANIZED BY

RECORD OF REVISION

Revision Date	Page	Contents	Editor
2011/06/22	--	New Release	Titan
2011/07/18	5,6	Correct the Current 120mA	Titan
2011/11/16	20,21	Modify LED cable outline	Eric

1. INTRODUCTION

This is a color active matrix TFT-LCD that uses amorphous silicon TFT as a switching device . This model is composed of a 5.7inch TFT-LCD panel, a driving circuit. This TFT-LCD has a high resolution (640(R.G.B) X 480) and can display up to 262,144 colors .

1-1. Features

- VGA Resolution
- 6 Bits color driver with 1 channel TTL interface
- Wide range operation temperature
- Improved inner FPC material to better reliability.

2. PHYSICAL SPECIFICATIONS

Item	Specifications	unit
Display resolution(dot)	640RGB (W) x 480(H)	dots
Display area	115.2 (W) x 86.4 (H)	mm
Pixel pitch	0.18 (W) x 0.18 (H)	mm
Color configuration	R.G.B Vertical stripe	
Overall dimension	127.0(W)x99.63(H)x9.26(D)	mm
Surface treatment	Antiglare , Hard-Coating(3H)	
Brightness	1000	cd/m ²
Contrast ratio	600 : 1	
Backlight unit	LED	
Display color	262,144	colors
Viewing Direction	6 o'clock (Gray Inversion)	
Display Mode	Normally White	

3. ABSOLUTE MAXIMUM RATINGS

ITEM	SYMBOL	MIN	MAX	UNIT
Power Supply Voltage	Vcc	-0.5	5	V
Signal Input Voltage	DCLK , DE R0~R5 G0~G5 B0~B5	-0.5	Vcc + 0.5	V
Operation Temperature	Top	-20	70	°C
Storage Temperature	Tstg	-30	80	°C

The following values are maximum operation conditions , If exceeded , it may cause faulty operation or damage

4. ELECTRICAL CHARACTERISTICS

4-1 TFT LCD Module voltage

ITEM	SYMBOL	MIN	TYP	MAX	UNIT	NOTE
Power Voltage For LCD	V_{CC}	3.0	3.3	3.6	V	
Logic Input Voltage	V_{IH}	$V_{CC} \times \frac{0.7}{7}$	--	V_{CC}	V	
	V_{IL}	0	--	$V_{CC} \times \frac{0.3}{3}$	V	
	V_{IL}	GND	--	0.3	V	

4-2 LED Backlight Conditions

ITEM	SYMBOL	MIN	TYP	MAX	UNIT	NOTE
LED Backlight Voltage	V_{BL}	17.4	19.2	21.6	V	
LED Backlight Current	I_{BL}	-	120	-	mA	$T_a=25^\circ\text{C}$
LED Life Time			30K		Hr	Note*

Note* : Brightness to be decreased to 50% of the initial value.

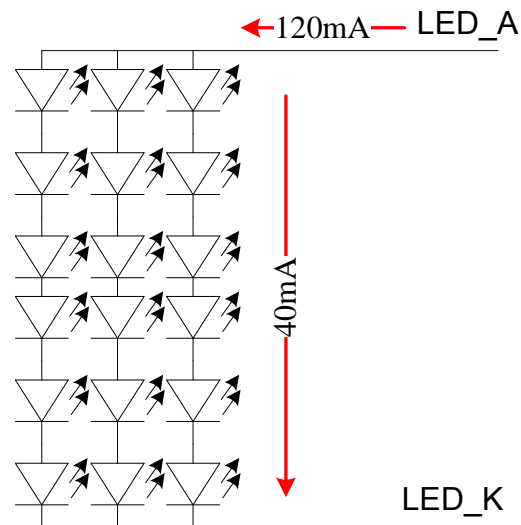

The constant current source is needed for white LED back-light driving.

When LCM is operated over 60°C ambient temperature, the I_{BL} of the LED back-light should be adjusted to 100mA max

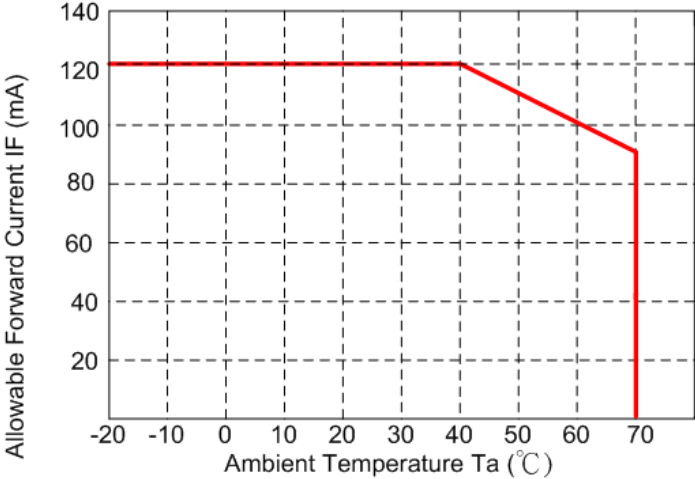

5. INTERFACE

Pin No	Symbol	Function
1	U/D	Up or Down Display Control
2	DMS(NC)	No connection
3	Hsync(NC)	Horizontal SYNC. (Sync mode used)
4	VLED	No connection
5	VLED	No connection
6	VLED	No connection
7	Vcc	Power Supply for LCD
8	Vsync(NC)	Vertical SYNC. (Sync mode used)
9	DE	Data Enable
10	Vss	Power Ground
11	Vss	Power Ground
12	ADJ	No connection
13	B5	Blue Data 5 (MSB)
14	B4	Blue Data 4
15	B3	Blue Data 3
16	Vss	Power Ground
17	B2	Blue Data 2
18	B1	Blue Data 1
19	B0	Blue Data 0 (LSB)
20	Vss	Power Ground
21	G5	Green Data 5 (MSB)
22	G4	Green Data 4
23	G3	Green Data 3
24	Vss	Power Ground
25	G2	Green Data 2
26	G1	Green Data 1
27	G0	Green Data 0 (LSB)
28	Vss	Power Ground
29	R5	Red Data 5 (MSB)
30	R4	Red Data 4
31	R3	Red Data 3
32	Vss	Power Ground
33	R2	Red Data 2
34	R1	Red Data 1
35	R0	Red Data 0 (LSB)
36	Vss	Power Ground
37	Vss	Power Ground
38	DCLK	Clock Signals
39	Vss	Power Ground
40	L/R	Left or Right Display Control

NOTE:

1. VSS Pin must ground contact, can not be floating.

2. U/D and L/R are controlled function

L/R	U/D	Function
1	0	Normally display
0	0	Left and Right opposite
1	1	Up and Down opposite
0	1	Left and Right opposite , Up and Down opposite

6. INPUT SIGNAL

6-1 Timing Specification.

PARAMETER	Symbol	Min.	Typ.	Max	Unit
CLK frequency	F_{CPH}		25.175		MHz
CLK period	T_{CPH}	-	39.7	-	ns
CLK pulse duty	T_{CWH}	40	50	60	%
HS period	T_H	-	800	-	T_{CPH}
HS pulse width	T_{WH}	5	30	-	T_{CPH}
HS-first horizontal data time	T_{HS}	112	144	175	T_{CPH}
DEN pulse width	T_{EP}	-	640	-	T_{CPH}
VS pulse width	T_{WV}	1	3	5	T_H
VS-DEN time	T_{STV}	-	35	-	T_H
VS period	T_V	-	525	-	T_H

Note: When SYNC mode is used, 1st data start from 144th CLK after HS falling
(when $STHD[5:0]=00000$)

PARAMETER	Symbol	Min.	Typ.	Max	Unit
OEV pulse width	T_{OEV}		100	-	T_{CPH}
CKV pulse width	T_{CKV}	-	96	-	T_{CPH}
HS-CKV time	T_1	-	52	-	T_{CPH}
HS-OEV time	T_2	-	8	-	T_{CPH}
HS-POL time	T_3	-	72	-	T_{CPH}
STV setup time	T_{SUV}	-	46	-	T_{CPH}
STV pulse width	T_{WSTV}	-	1	-	T_H

6-2 Timing chart

Clock and Data input waveforms

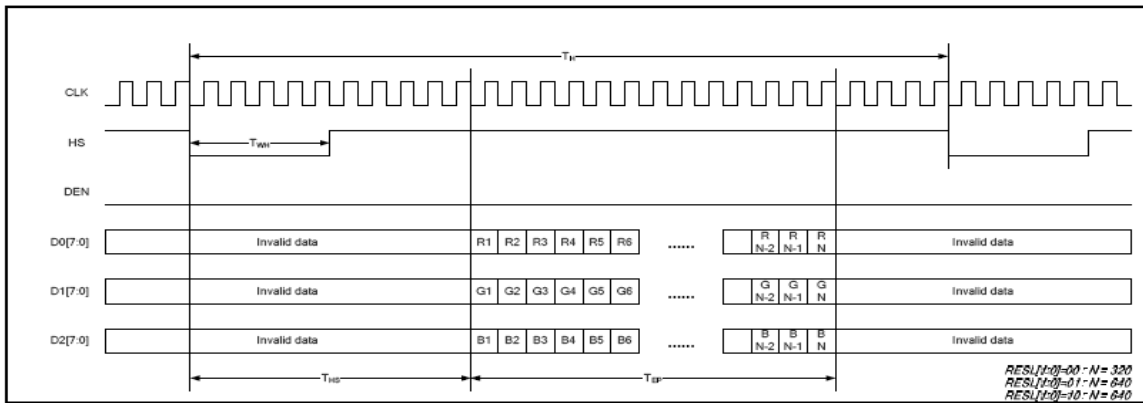
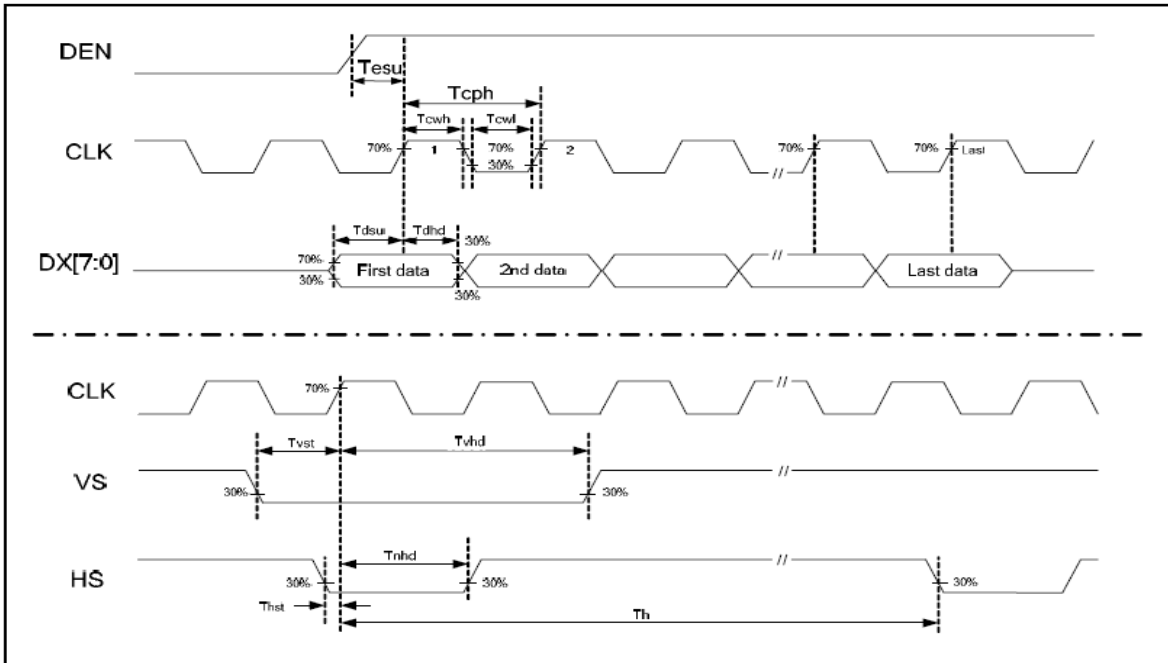

Parallel RGB SYNC Mode Horizontal Data Format

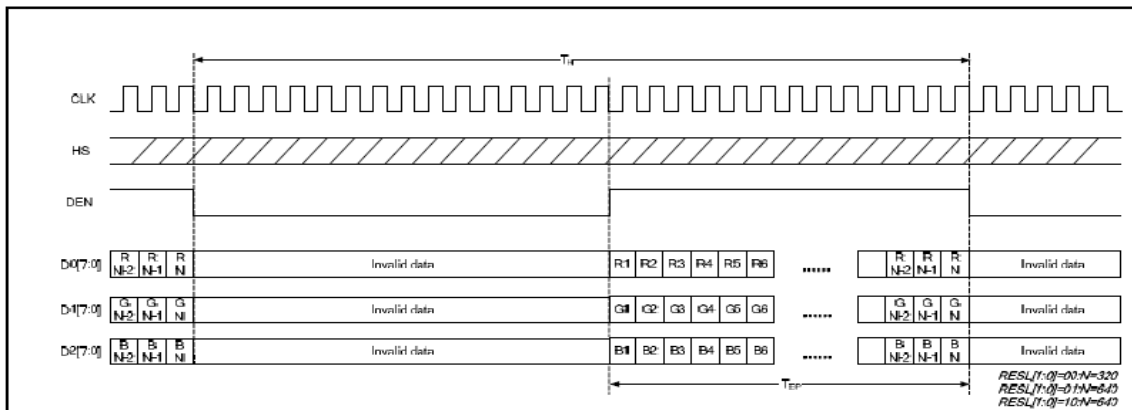

Parallel RGB DE Mode Horizontal Data Format

6-3 Color Data Assignment

COLOR	Input Data	R DATA						G DATA						B DATA					
		R5 MSB	R4	R3	R2	R1	R0 LSB	G5 MSB	G4	G3	G2	G1	G0 LSB	B5 MSB	B4	B3	B2	B1	B0 LSB
BASIC COLOR	BLACK	0	0	0	0	0	0	0	0	0	0	0	0	0	0	0	0	0	
	RED(63)	1	1	1	1	1	1	0	0	0	0	0	0	0	0	0	0	0	
	GREEN(63)	0	0	0	0	0	0	1	1	1	1	1	0	0	0	0	0	0	
	BLUE(63)	0	0	0	0	0	0	0	0	0	0	0	1	1	1	1	1	1	
	CYAN	0	0	0	0	0	0	1	1	1	1	1	1	1	1	1	1	1	
	MAGENTA	1	1	1	1	1	1	0	0	0	0	0	1	1	1	1	1	1	
	YELLOW	1	1	1	1	1	1	1	1	1	1	1	0	0	0	0	0	0	
	WHITE	1	1	1	1	1	1	1	1	1	1	1	1	1	1	1	1	1	
RED	RED(0)	0	0	0	0	0	0	0	0	0	0	0	0	0	0	0	0	0	
	RED(1)	0	0	0	0	0	1	0	0	0	0	0	0	0	0	0	0	0	
	RED(2)	0	0	0	0	1	0	0	0	0	0	0	0	0	0	0	0	0	
	RED(62)	1	1	1	1	1	0	0	0	0	0	0	0	0	0	0	0	0	
	RED(63)	1	1	1	1	1	1	0	0	0	0	0	0	0	0	0	0	0	
GREEN	GREEN (0)	0	0	0	0	0	0	0	0	0	0	0	0	0	0	0	0	0	
	GREEN (1)	0	0	0	0	0	0	0	0	0	0	1	0	0	0	0	0	0	
	GREEN (2)	0	0	0	0	0	0	0	0	0	0	1	0	0	0	0	0	0	
	GREEN (62)	0	0	0	0	0	0	1	1	1	1	1	0	0	0	0	0	0	
GREEN (63)	0	0	0	0	0	0	1	1	1	1	1	1	0	0	0	0	0		
BLUE	BLUE (0)	0	0	0	0	0	0	0	0	0	0	0	0	0	0	0	0	0	
	BLUE (1)	0	0	0	0	0	0	0	0	0	0	0	0	0	0	0	0	1	
	BLUE (2)	0	0	0	0	0	0	0	0	0	0	0	0	0	0	0	1	0	
	BLUE (62)	0	0	0	0	0	0	0	0	0	0	0	0	0	0	0	0	1	
BLUE (63)	0	0	0	0	0	0	0	0	0	0	0	0	0	0	0	1	0		

- NOTE: (1) Definition of Gray Scale, Color (n): n is series of Gray Scale
The more n value is the bright Gray Scale
(2) Data: 1-High, 0-Low

7. OPTICAL CHARACTERISTICS

Item	Symbol	Condition	Min.	Typ.	Max.	Unit	Note	
Contrast ratio	CR	Point - 5 $\Theta = \Phi = 0^\circ$	500	600	--	--	(1)(2)(3)	
Luminance	Lw		--	1000	-	cd/m ²	(1)(3)	
Luminance Uniformity	ΔL		70	75	-	%	(1)(3)	
Response Time (White – Black)	$T_r + T_f$		--	50	--	ms	(1)(3)(5)	
Viewing Angle	Vertical	Θ	$CR \geq 10$	100	130	--	Deg.	(1)(2)(4)
	Horizontal	Φ		120	150	--		
Color chromaticity	Red	Rx	Point - 5 $\Theta = \Phi = 0^\circ$	0.566	0.616	0.666	--	(1)(3)
		Ry		0.302	0.352	0.402		
	Green	Gx		0.308	0.358	0.408		
		Gy		0.518	0.568	0.618		
	Blue	Bx		0.096	0.146	0.196		
		By		0.086	0.136	0.186		
	White	Wx		0.279	0.329	0.379		
		Wy		0.301	0.351	0.401		

NOTE:

- (1) Measure conditions : $25^\circ\text{C} \pm 2^\circ\text{C}$, $60 \pm 10\% \text{RH}$ under 10Lux , in the dark room by BM-7TOPCON) , viewing 2° , VCC=3.3V , VDD=3.3V

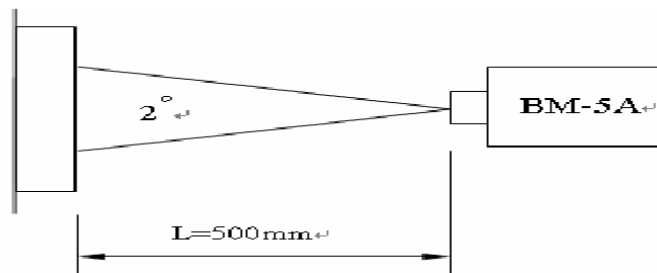

- (2) Definition of Contrast Ratio :

Contrast Ratio (CR) = (White) Luminance of ON \div (Black) Luminance of OFF

- (3) Definition of Luminance :

Definition of Luminance Uniformity

Measure white luminance on the point 5 as figure8-1

Measure white luminance on the point 1 ~ 9 as figure8-1

$$\Delta L = [L(\text{MIN}) / L(\text{MAX})] \times 100\%$$

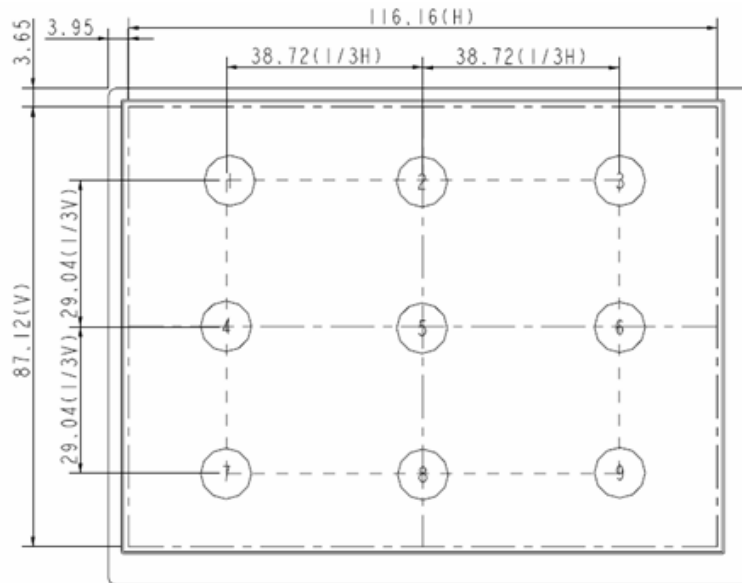

Figure 8-1

(4) Definition of Viewing Angle(Θ, Φ), refer to Fig8-2 as below :

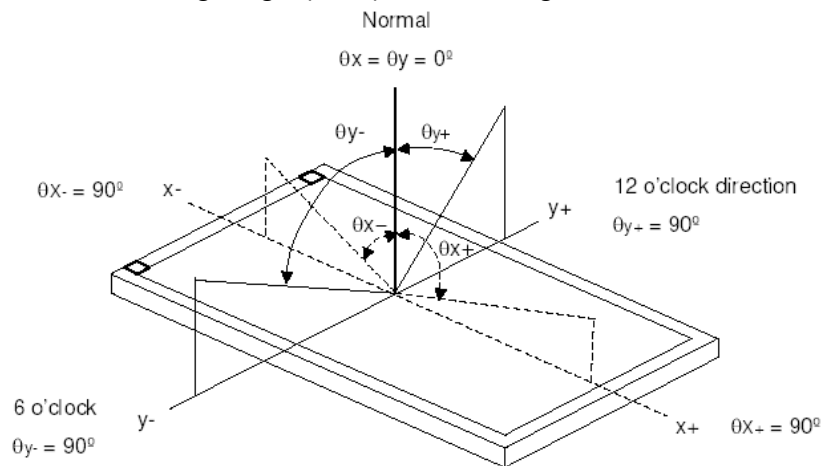
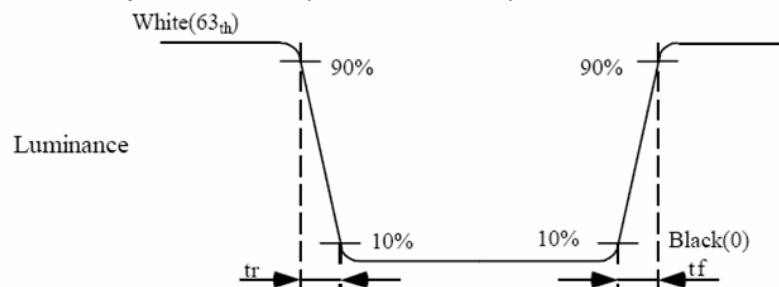

Figure 8-2

(5) Definition of Response Time.(White – Black)



8. QUALITY AND RELIABILITY

8.1. INSPECTION QUALITY CRITERIA

8.1.1. Scope

Specifications contain

8.1.1.1 Display Quality Evaluation

8.1.1.2 Mechanics Specification

8.1.2. Sampling Plan

Unless there is other agreement, the sampling plan for incoming inspection shall follow MIL-STD-105E LEVEL II.

8.1.2.1 Lot size: Quantity per shipment as one lot (different model as different lot).

8.1.2.2 Sampling type: Normal inspection, single sampling.

8.1.2.3 Sampling level: Level II.

8.1.2.4 AQL: Acceptable Quality Level

Major defect: AQL=0.65

Minor defect: AQL=1.0

8.1.3. Panel Inspection Condition

8.1.3.1 Environment:

Room Temperature: $25\pm 5^{\circ}\text{C}$.

Humidity: $65\pm 5\%$ RH.

Illumination: 300 ~ 700 Lux.

8.1.3.2 Inspection Distance:

35-40 cm

8.1.3.3 Inspection Angle:

The vision of inspector should be perpendicular to the surface of the Module.

8.1.3.4 Inspection time :

Perceptibility Test Time: 20 seconds max.

8.1.4. Display Quality

8.1.4.1 Function Related:

The function defects of line defect, abnormal display, and no display are considered Major defects.

8.1.4.2 Bright/Dark Dots:

Defect Type / Specification	G0 Grade	A Grade
Bright Dots	0	$N \leq 1$
Dark Dots	0	$N \leq 3$
Total Bright and Dark Dots	0	$N \leq 3$

[Note 1]

Judge defect dot and adjacent dot as following.

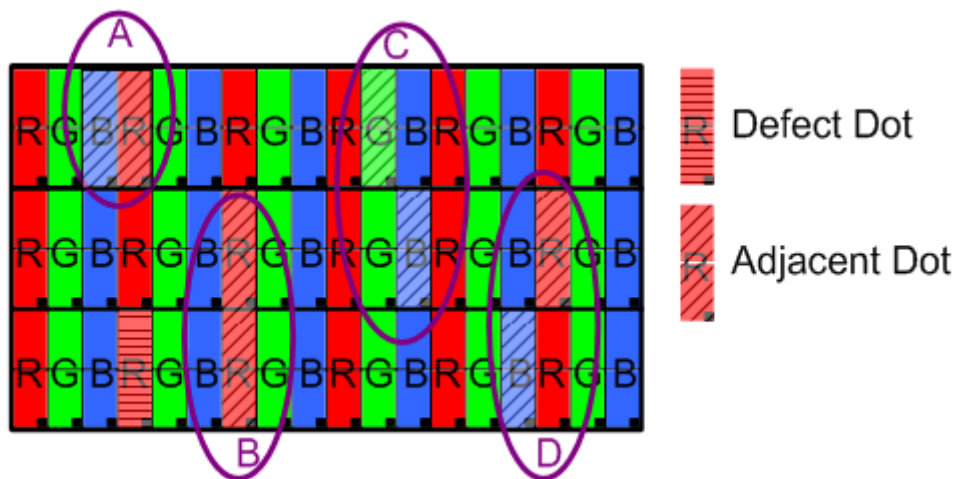

- (1) One pixel consists of 3 sub-pixels, including R,G, and B dot.(Sub-pixel = Dot)
- (2) The definition of dot: The size of a defective dot over 1/2 of whole dot is regarded as one defective dot.
- (3) Allow above (as A, B, C and D status) adjacent defect dots, including bright and dark adjacent dot. And they will be counted 2 defect dots in total quantity.
- (4) Defects on the Black Matrix, out of Display area, are not considered as a defect or counted.
- (5) There should be no distinct non-uniformity visible through 6% ND Filter within 2 sec inspection times.

8.1.4.3 Visual Inspection specifications:

Defect Type	Specification	Count(N)
Dot Shape (Particle, Scratch and Bubbles in display area)	$D \leq 0.15\text{mm}$	Ignored
	$0.15\text{mm} < D \leq 0.3\text{mm}$	$N \leq 3$
	$D > 0.3\text{mm}$	$N=0$
Line Shape (Particles, Scratch, Lint and Bubbles in display area)	$W \leq 0.05\text{mm}$	Ignored
	$0.05\text{mm} < W \leq 0.1\text{mm}$, $L \leq 3\text{mm}$	$N \leq 3$
	$W > 0.1\text{mm}$, $L > 3\text{mm}$	$N=0$

[Note 2] W : Width[mm], L : Length[mm], N : Number, ϕ : Average Diameter

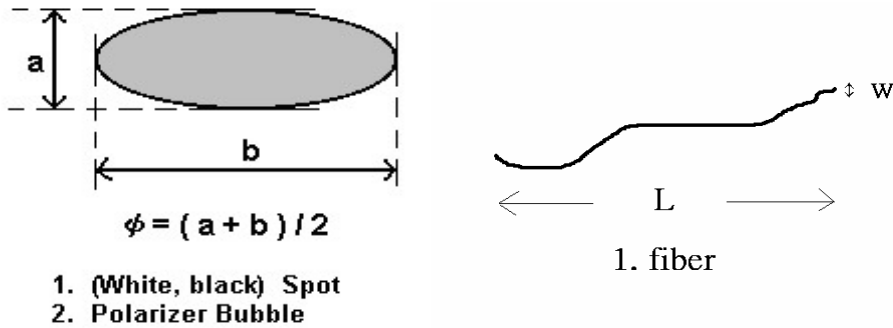

[Note 3] Bright dot is defined through 6% transmission ND Filter as following.

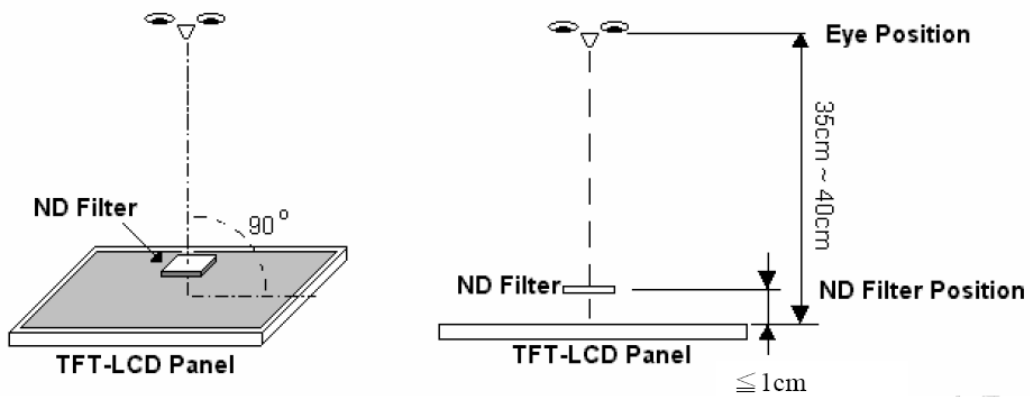

9. RELIABILITY TEST CONDITIONS

ITEM	CONDITIONS
HIGH TEMPERATURE OPERATION	70°C , 240Hrs
HIGH TEMPERATURE AND HIGH HUMIDITY OPERATION	60°C , 90%RH , 240Hrs
HIGH TEMPERATURE STORAGE	80°C , 240Hrs
LOW TEMPERATURE OPERATION	-20°C , 240Hrs
LOW TEMPERATURE STORAGE	-30°C , 240Hrs
THERMAL SHOCK	-30°C (0.5Hr) ~80°C (0.5Hr) 200Cycle

10. USE PRECAUTIONS

10-1 Handling precautions

- (1) The polarizing plate may break easily so be careful when handling it. Do not touch, press or rub it with a hard-material tool like tweezers.
- (2) Do not touch the polarizing plate surface with bare hands so as not to make it dirty. If the surface or other related part of the polarizing plate is dirty, soak a soft cotton cloth or chamois leather in benzine and wipe off with it. Do not use chemical liquids such as acetone, toluene and isopropyl alcohol. Failure to do so may bring chemical reaction phenomena and deteriorations.
- (3) Remove any spit or water immediately. If it is left for hours, the suffered part may deform or decolorize.
- (4) If the LCD element breaks and any LC stuff leaks, do not suck or lick it. Also if LC stuff is stuck on your skin or clothing, wash thoroughly with soap and water immediately.

10-2 Installing precautions

- (1) The PCB has many ICs that may be damaged easily by static electricity. To prevent breaking by static electricity from the human body and clothing, earth the human body properly using the high resistance and discharge static electricity during the operation. In this case, however, the resistance value should be approx. $1M\Omega$ and the resistance should be placed near the human body rather than the ground surface. When the indoor space is dry, static electricity may occur easily so be careful. We recommend the indoor space should be kept with humidity of 60% or more. When a soldering iron or other similar tool is used for assembly, be sure to earth it.
- (2) When installing the module and ICs, do not bend or twist them. Failure to do so may crack LC element and cause circuit failure.
- (3) To protect LC element, especially polarizing plate, use a transparent protective plate (e.g., acrylic plate, glass etc) for the product case.
- (4) Do not use an adhesive like a both-side adhesive tape to make LCD surface (polarizing plate) and product case stick together. Failure to do so may cause the polarizing plate to peel off

10-3 Storage precautions

- (1) Avoid a high temperature and humidity area. Keep the temperature between 0°C and 35°C and also the humidity under 60%.
- (2) Choose the dark spaces where the product is not exposed to direct sunlight or fluorescent light.
- (3) Store the products as they are put in the boxes provided from us or in the same conditions as we recommend.

10-4 Operating precautions

- (1) Do not boost the applied drive voltage abnormally. Failure to do so may break ICs. When applying power voltage, check the electrical features beforehand and be careful. Always turn off the power to the LC module controller before removing or inserting the LC module input connector. If the input connector is removed or inserted while the power is turned on, the LC module internal circuit may break.
- (2) The display response may be late if the operating temperature is under the normal standard, and the display may be out of order if it is above the normal standard. But this is not a failure; this will be restored if it is within the normal standard.
- (3) The LCD contrast varies depending on the visual angle, ambient temperature, power voltage etc. Obtain the optimum contrast by adjusting the LC drive voltage.
- (4) When carrying out the test, do not take the module out of the low-temperature space suddenly. Failure to do so will cause the module condensing, leading to malfunctions.
- (5) Make certain that each signal noise level is within the standard (L level: 0.2V_{dd} or less and H level: 0.8V_{dd} or more) even if the module has functioned properly. If it is beyond the standard, the module may often malfunction. In addition, always connect the module when making noise level measurements.
- (6) The CMOS ICs are incorporated in the module and the pull-up and pull-down function is not adopted for the input so avoid putting the input signal open while the power is ON.
- (7) The characteristic of the semiconductor element changes when it is exposed to light emissions, therefore ICs on the LCD may malfunction if they receive light emissions. To prevent these malfunctions, design and assemble ICs so that they are shielded from light emissions.
- (8) Crosstalk occurs because of characteristics of the LCD. In general, crosstalk occurs when the regularized display is maintained. Also, crosstalk is affected by the LC drive voltage. Design the contents of the display, considering crosstalk.

10-5 Other

- (1) Do not disassemble or take the LC module into pieces. The LC modules once disassembled or taken into pieces are not the guarantee articles.
- (2) The residual image may exist if the same display pattern is shown for hours. This residual image, however, disappears when another display pattern is shown or the drive is interrupted and left for a while. But this is not a problem on reliability.
- (3) AMIPRE will provide one year warranty for all products and three months warranty for all repairing products..

11. OUTLINE DIMENSION

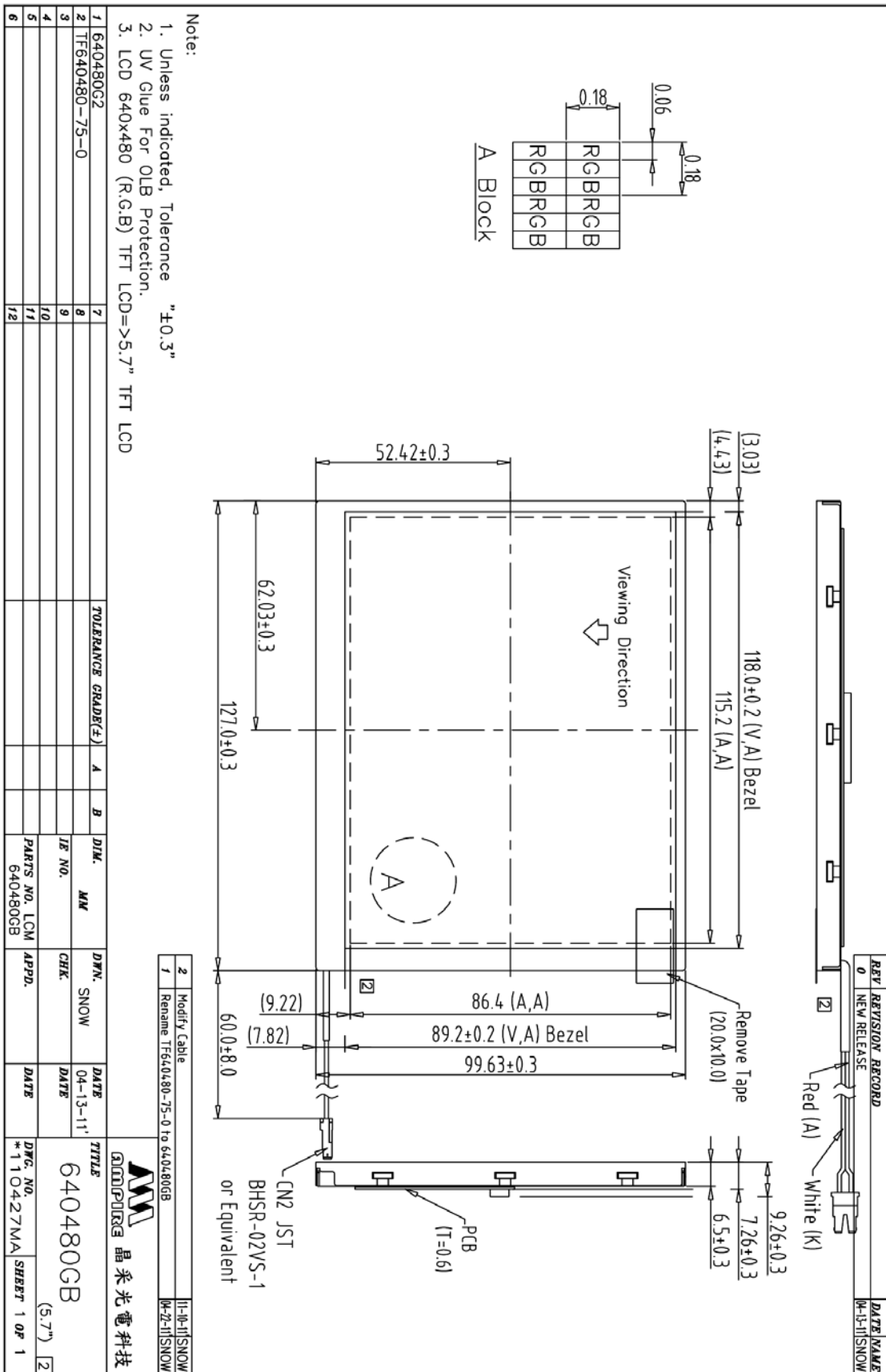

- Note:
1. Unless indicated, Tolerance "±0.3"
 2. UV Glue For OLB Protection.
 3. LCD 640x480 (R.G.B) TFT LCD=>5.7" TFT LCD

REV	REVISION RECORD	DATE	NAME
0	NEW RELEASE	04-13-11	SNOW
1	Rename TF640480-75-0 to 640480GB	04-24-11	SNOW
2	Modify Cable	11-04-11	SNOW

CN1			
1	U/D	21	G5
2	DMS(NC)	22	G4
3	HSYNC(NC)	23	G3
4	VLED	24	VSS
5	VLED	25	G2
6	VLED	26	G1
7	VCC	27	G0
8	VS SYNC(NC)	28	VSS
9	DE	29	R5
10	VSS	30	R4
11	VSS	31	R3
12	ADJ	32	VSS
13	B5	33	R2
14	B4	34	R1
15	B3	35	RO
16	VSS	36	VSS
17	B2	37	VSS
18	B1	38	CLK
19	B0	39	VSS
20	VSS	40	L/R

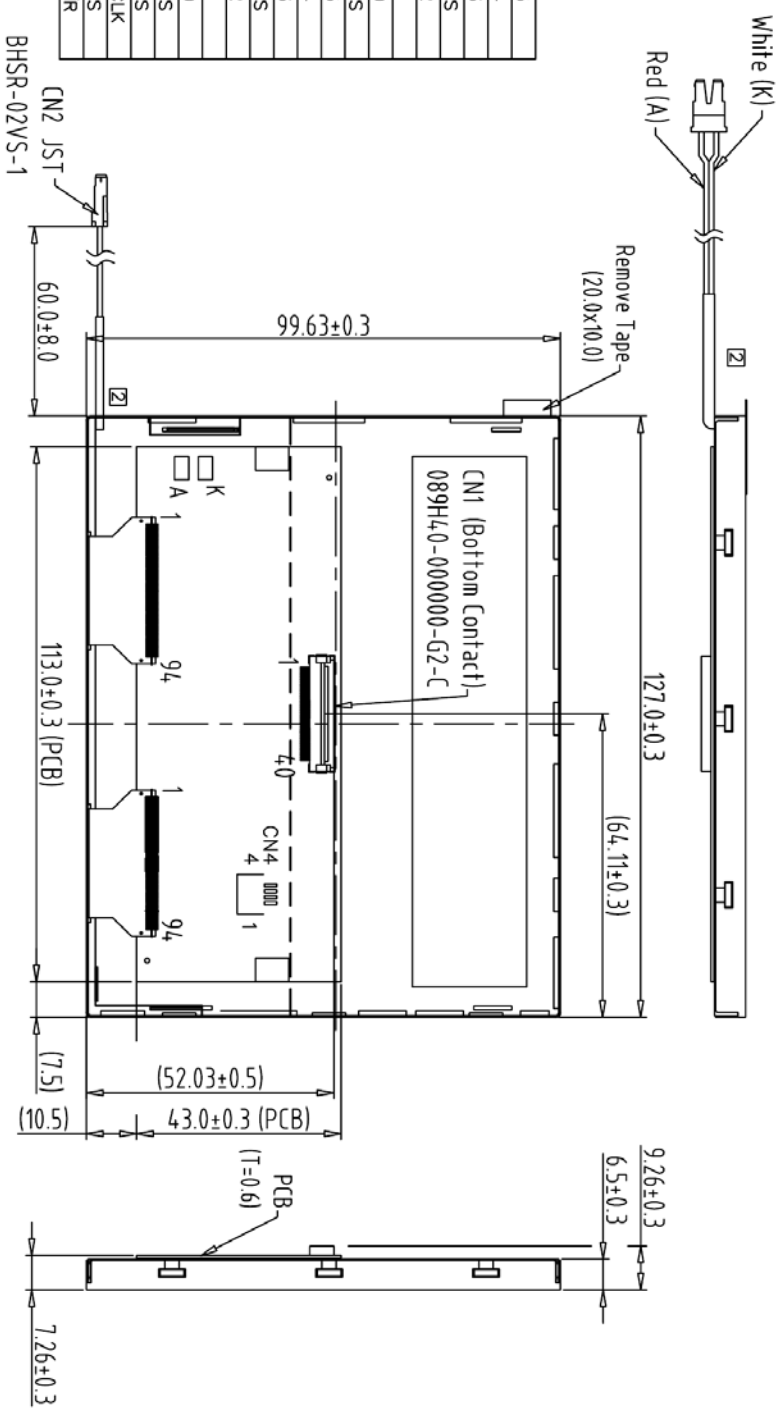

- Note:
- Unless indicated, Tolerance "±0.3"
 - UV Glue For OLB Protection.
 - Main LCD 640x480 (R.G.B) TFT LCD => 5.7" TFT LCD

REV	REVISION RECORD	DATE	NAME
0	NEW RELEASE	04-13-11	SNOW
1	Rename TF640480-75-0 to 640480GB	04-24-11	SNOW
2	Modify Cable	11-04-11	SNOW

REV	TITLE	DWG. NO.	SHEET
1	640480GB	*110428MA	1 OF 1
2			

REV	TITLE	DWG. NO.	SHEET
1	640480GB	*110428MA	1 OF 1
2			