



晶采光電科技股份有限公司  
AMPIRE CO., LTD.

## SPECIFICATIONS FOR LCD MODULE

<b>CUSTOMER</b>	
<b>CUSTOMER PART NO.</b>	
<b>AMPIRE PART NO.</b>	<b>AM-240320J4TZQW-00H</b>
<b>APPROVED BY</b>	
<b>DATE</b>	

Approved For Specifications



Approved For Specifications & Sample

**AMPIRE CO., LTD.**

**4F., No.116, Sec. 1, Xintai 5th Rd., Xizhi Dist., New Taipei City 221,  
Taiwan (R.O.C.)**

**221 新北市 汐止區 新台五路一段 116 號 4 樓(東方科學園區 A 棟)**

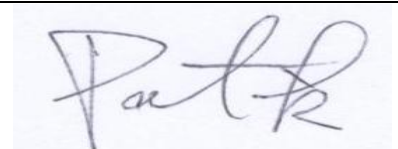
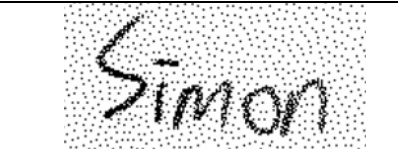
**TEL:886-2-26967269 , FAX:886-2-26967196 or 26967270**

APPROVED BY	CHECKED BY	ORGANIZED BY
		

## RECORD OF REVISION

<b>Revision Date</b>	<b>Page</b>	<b>Contents</b>	<b>Editor</b>
2013/11/22	-	New Release	Patrick
2014/6/18	1,5,7	Modify Features, Electrical specifications, Optical characteristics.	Alan
2016/3/31	3	Mention the specification of light shielding adhesive tape.	Emil

## 1 Features

This single-display module is suitable for cellphone application. The Main-LCD adopts one backlight with High brightness 3-lamps white LED.

(1) Main LCD : 1.1 MVA-TFT 2.2 inch display, transmissive, Normally Black

1.2 240(RGB) X 320 dots Matrix

1.3 Narrow-contact ledge technique.

1.4 Main LCD Driver IC: ST7789S-G4

1.5 Real 262K colors display:

65K: Red-5bit, Green-6bit, Blue-5bit (8/16-bit interface)

262K: Red-6bit, Green-6bit, Blue-6bit (9/18-bit interface)

(2) Direct data display with display RAM

(3) MPU interface: 8bit/16bit/18bit, 80Serial, parallel interface.

(4) RGB interface: 16bit/18bit parallel interface

(5) With light shielding adhesive tape, 3806BWH (SEKISUI CHEMICAL)

## 2 Mechanical specifications

### Dimensions and weight

Item		Specifications	Unit
External shape dimensions		40.1 (W) x 71.9 (H) x 3.65 (D) Max.	mm
Main LCD	Pixel pitch	0.1395 (W) x 0.1395(H)	mm
	Active area	33.48 (W) x 44.64 (H)	mm
	Viewing area	35.08 (W) x 46.24 (H)	mm

\*1. This specification is about External shape on shipment from AMPIRE.

## 3 Absolute max. ratings and environment

### 3-1 Absolute max. ratings

Ta=25°C GND=0V

Item	Symbol	Min.	Max.	Unit	Remarks
Power voltage	VDD – GND	-0.3	+4.0	V	
Power voltage	LED A – LED K	-0.5	+10.8	V	
Input voltage	VIN	-0.5	VDDI+0.5	V	

### 3-2 Environment

Item	Specifications	Remarks
Storage temperature	Max. +80 °C Min. -30 °C	Note 1: Non-condensing
Operating temperature	Max. +70 °C Min. -20 °C	Note 1: Non-condensing

Note 1 : Ta ≤ +40 °C . . . . Max.85%RH

Ta > +40 °C . . . . The max. humidity should not exceed the humidity with 40 °C 85%RH.

## 4 Electrical specifications

### 4-1 Electrical characteristics of LCM

( $V_{DD}=2.8V$ ,  $T_a=25^{\circ}C$ )

Item	Symbol	Conditions	MIN.	TYP.	MAX.	Unit	Note
IC power voltage	$V_{DD}$		2.4	2.75	3.3	V	
High-level input voltage	$V_{IHC}$		$0.8V_{DD}$		$V_{DD}$	V	Note 1,2,3
Low-level input voltage	$V_{ILC}$		0		$0.2V_{DD}$	V	
Consumption current of VDD	$I_{DD}$	LED OFF	-	7	14	mA	
Consumption current of LED	$I_{LED}$	$V_{LED}=8.7V$	-	15	20	mA	

- ※ 1. 1/320 duty.  
 2. Electronic Volumn value: (xxxxh) Decimal  
 3. Thermal Gradient:  $-0.05\%/^{\circ}C$   
 4. Range of Electronic Volumn control : (xxxxH±3) Decimal

## 4-2 LED back light specification

Item	Symbol	Conditions	MIN.	TYP.	MAX.	Unit
Forward voltage	$V_f$	$I_f = 15\text{mA}$	7.8	8.7	9.9	V
Reverse voltage	$V_r$		-	-	12	V
Forward current	$I_f$	3-chip serial	12	15	20	mA
Power Consumption	$P_{BL}$	$I_f = 15\text{mA}$	-	130	-	mW
Uniformity (with L/G)	-	$I_f = 15\text{mA}$	70%*1	-	-	
Luminous color	White					
Chip connection	3 chip serial connection					

Bare LED measure position:

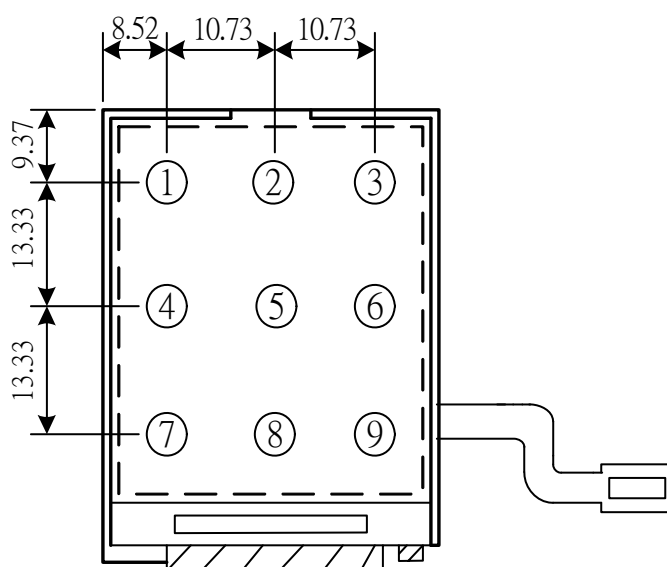

\*1 Uniformity (LT): 
$$\frac{\text{Min}(P1 \sim P9)}{\text{Max}(P1 \sim P9)} \times 100$$

## 5 Optical characteristics

### Main LCD

#### 5.1 Optical characteristics

(1/320 Duty in case except as specified elsewhere Ta = 25°C)

LED backlight transmissive module:

Item	Symbol	Temp.	Min.	Std.	Max.	Unit	Conditions
Response time	Tr+Tf		-	55	85	ms	$\theta = 0^\circ, \varphi = 0^\circ$ (Note 2)
Contrast ratio	CR	25 °C	300	700	-	-	$\theta = 0^\circ, \varphi = 0^\circ$ LED:ON, LIGHT:OFF (Note 4)
Visual angle range front and rear	$\theta$	25 °C	( $\theta$ f) 80 ( $\theta$ b) 80			Degree	$\varphi = 0^\circ, CR \geq 10$ LED:ON LIGHT:OFF (Note 3)
Visual angle range left and right	$\theta$	25 °C	( $\theta$ l) 80 ( $\theta$ r)80			Degree	$\varphi = 90^\circ, CR \geq 10$ LED:ON LIGHT:OFF (Note 3)
Brightness			300	400		Cd/m2	V <sub>LED</sub> =8.7V, 15mA Full White pattern

**\*This value is reference only, follow the limited samples.**

#### 5.2 CIE (x, y) chromaticity (1/320 Duty Ta = 25°C)

Item	Symbol	Tranmissive			Conditions
		R G B W Range			
		Min	Typ	Max	
Red	XR	0.59	0.64	0.69	$\theta = 0^\circ, \varphi = 0$ °
	YR	0.29	0.34	0.39	
Green	XG	0.28	0.33	0.38	$\theta = 0^\circ, \varphi = 0$ °
	YG	0.53	0.58	0.63	
Blue	XB	0.1	0.15	0.2	$\theta = 0^\circ, \varphi = 0$ °
	YB	0.01	0.06	0.11	
White	XW	0.27	0.32	0.37	$\theta = 0^\circ, \varphi = 0$ °
	YW	0.30	0.35	0.40	

※ The R G B W ranges are for reference

**NOTE 1: Optical characteristic measurement system**

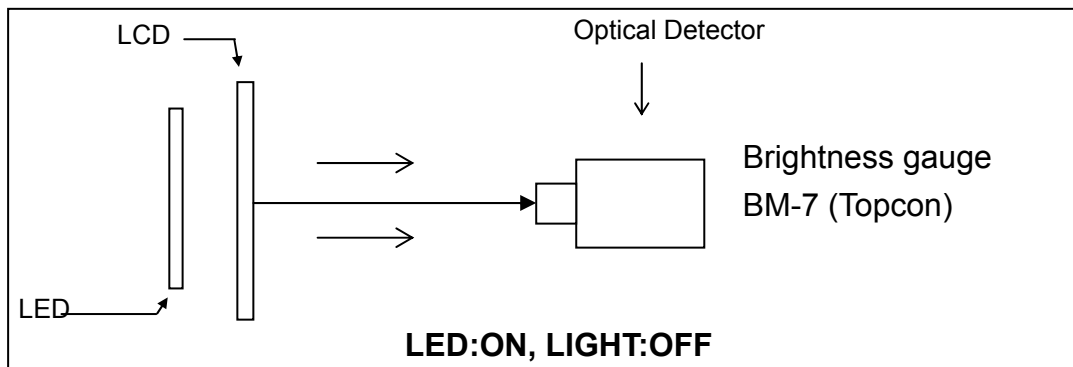
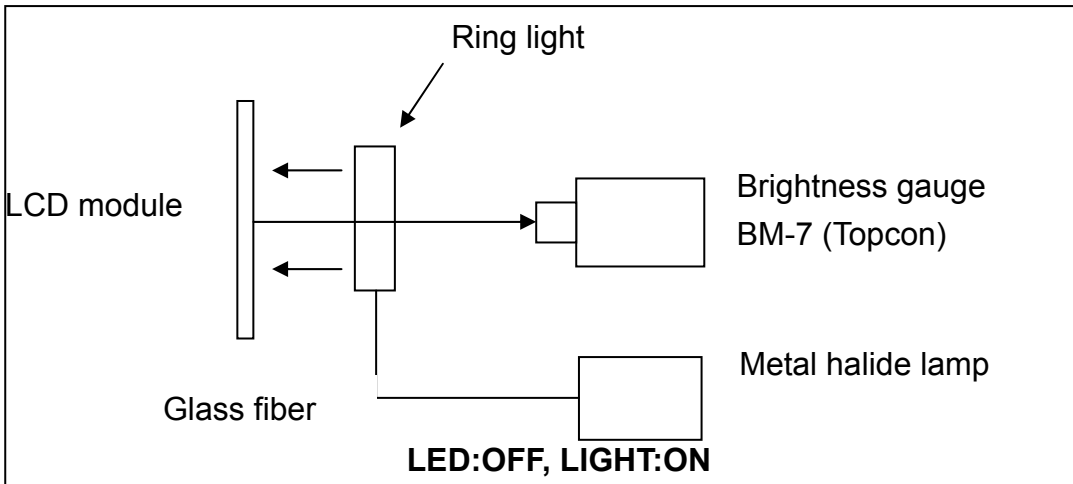

**NOTE 2: Response time definition**

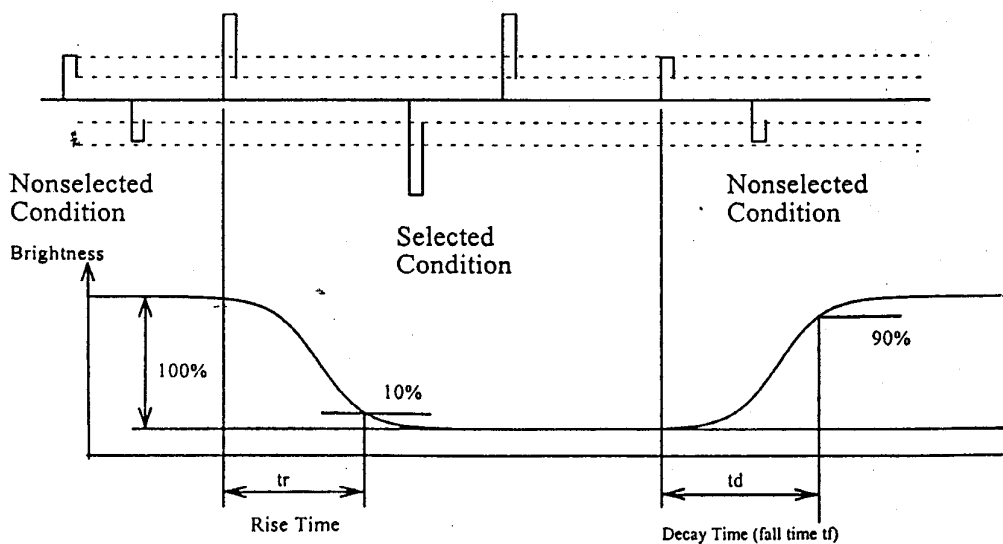



**NOTE 3:  $\varphi$ 、 $\theta$  definition**

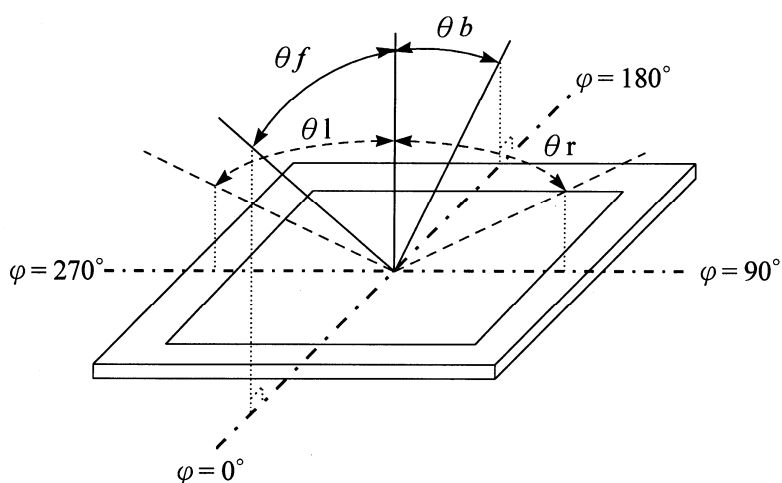

**NOTE 4: Contrast definition**

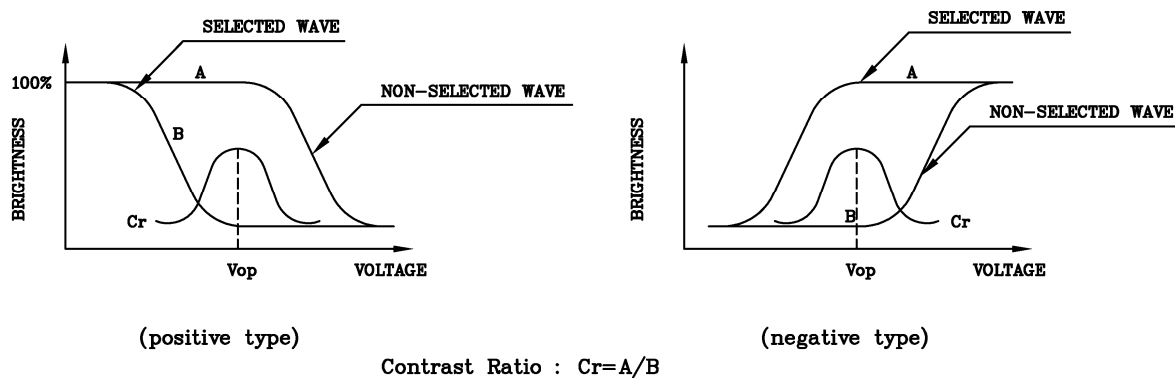

**NOTE 5: Visual angle direction priority**

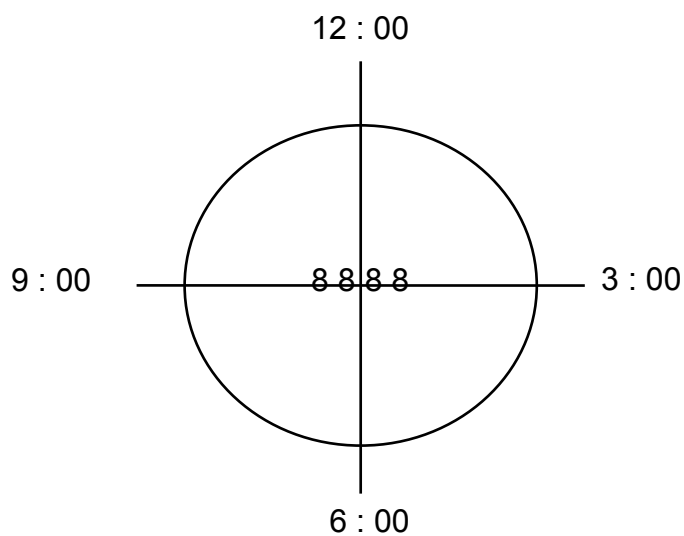

## 6 Block Diagram

### Block diagram (Main LCD)

Display format: MVA- TFT transmissive, Normally black type

Display composition: 240 RGB x 320 dots

LCD Driver : ST7789S-G4

Back light: White LED x 3 ( $I_{LED}=15mA$ )

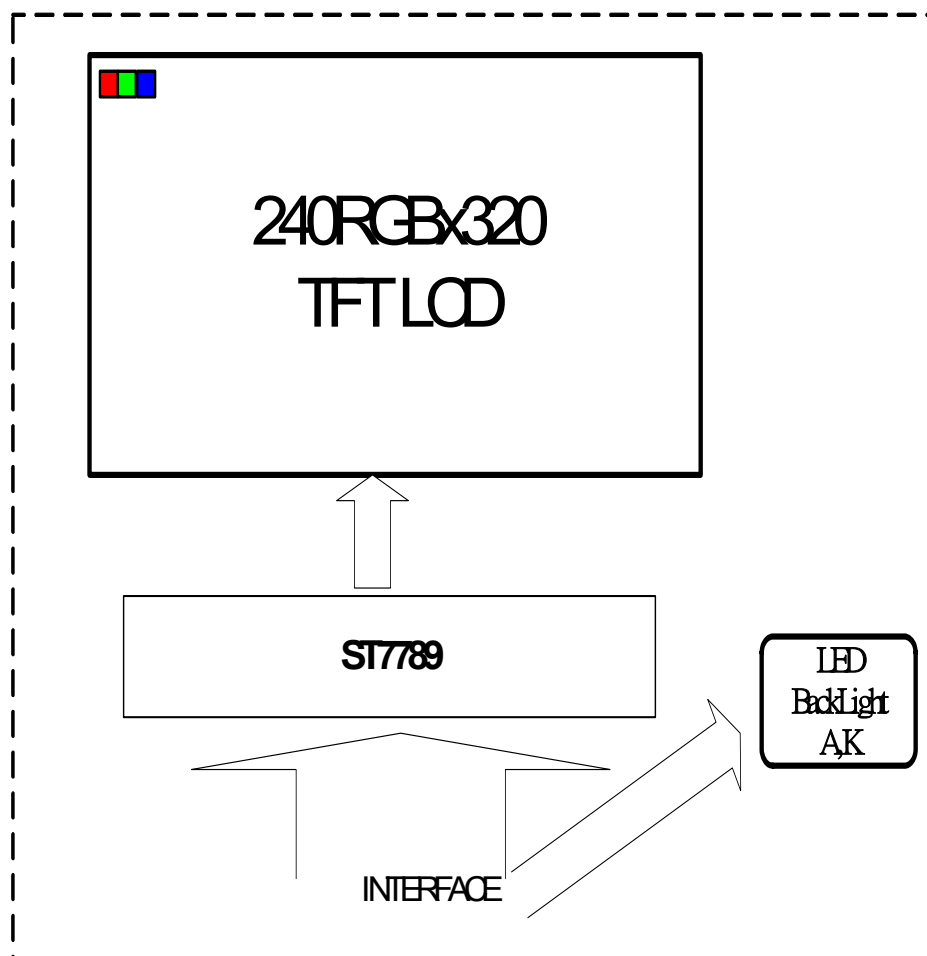

## 7 Interface specifications

Pin No.	Terminal	Functions
1	GND	Ground
2	GND	Ground
3	CSX	-Chip selection pin Low enable. High disable.
4	DCX	-Display data/command selection pin in parallel interface. -This pin is used to be serial interface clock. DCX='1': display data or parameter. DCX='0': command data. -If not used, please fix this pin at VDDI or DGND.
5	WRX	-Write enable in MCU parallel interface. - Display data/command selection pin in 4-line serial - Second Data lane in 2 data lane serial interface. -If not used, please fix this pin at VDDI or DGND.
6	RDX	-Read enable in 8080 MCU parallel interface. -If not used, please fix this pin at VDDI or DGND.
7	RESX	-This signal will reset the device and it must be applied to properly initialize the chip. -Signal is active low.
8	DB0	<p>-DB[17:0] are used as MCU parallel interface data bus.</p> <p>8-bit I/F: when IM3:0, DB[7:0] are used; when IM3:1, DB[17:10] are used.</p> <p>9-bit I/F: when IM3:0, DB[8:0] are used; when IM3:1, DB[17:9] are used.</p> <p>16-bit I/F: when IM3:0, DB[15:0] are used; when IM3:1, DB[17:10] and DB[8:1] are used.</p> <p>18-bit I/F: DB[17:0] are used.</p> <p>-DB[17:0] are used as RGB interface data bus.</p> <p>6-bit RGB I/F: DB[5:0] are used.</p> <p>16-bit RGB I/F: DB[17:13], DB[11:1] are used.</p> <p>18-bit RGB I/F: DB[17:0] are used.</p> <p>-If not used, please fix this pin at VDDI or DGND.</p>
9	DB1	
10	DB2	
11	DB3	
12	DB4	
13	DB5	
14	DB6	
15	DB7	
16	DB8	
17	DB9	
18	DB10	
19	DB11	
20	DB12	
21	DB13	
22	DB14	
23	DB15	
24	LED A	Led Anode
25	LED K	Led Cathode
26	DB16	Data Bus
27	DB17	
28	IM3	Interface selecting signal. For the details, please refer to NOTE1.
29	IM2	Interface selecting signal. For the details, please refer to NOTE1.

30	IM1	Interface selecting signal. For the details, please refer to NOTE1.
31	IM0	Interface selecting signal. For the details, please refer to NOTE1.
32	SDA	Serial bus interface data input
33	SDO	SPI interface output pin.
34	VSYNC	Frame synchronizing signal in RGB I/F mode.
35	HSYNC	Horizontal (Line) synchronizing input signal for RGB interface
36	DOTCLK	Dot clock signal in RGB I/F mode.
37	NC(ENABLE)	No Connect
38	NC	No Connect
39	VDD	Power Supply Power Supply for Analog, Digital System and Booster Circuit.
40	VDDI	Power Supply for I/O System.

Note 1:

IM3	IM2	IM1	IM0	MPU Interface Mode	Data pin
0	0	0	0	80-8bit parallel I/F	DB[7:0]
0	0	0	1	80-16bit parallel I/F	DB[15:0]
0	0	1	0	80-9bit parallel I/F	DB[8:0]
0	0	1	1	80-18bit parallel I/F	DB[17:0],
0	1	0	1	3-line 9bit serial I/F	SDA: in/out
				2 data lane serial I/F	SDA: in/out WRX: in
0	1	1	0	4-line 8bit serial I/F	SDA: in/out
1	0	0	0	80-16bit parallel I/F II	DB[17:10], DB[8:1]
1	0	0	1	80-8bit parallel I/F II	DB[17:10]
1	0	1	0	80-18bit parallel I/F II	DB[17:0],
1	0	1	1	80-9bit parallel I/F II	DB[17:9]
1	1	0	1	3-line 9bit serial I/F II	SDA: in/ SDO: out
1	1	1	0	4-line 8bit serial I/F II	SDA:in/ SDO: out

## 8 Timing Characteristics

8080 Series MCU Parallel Interface Characteristics: 18/16/9/8-bit Bus

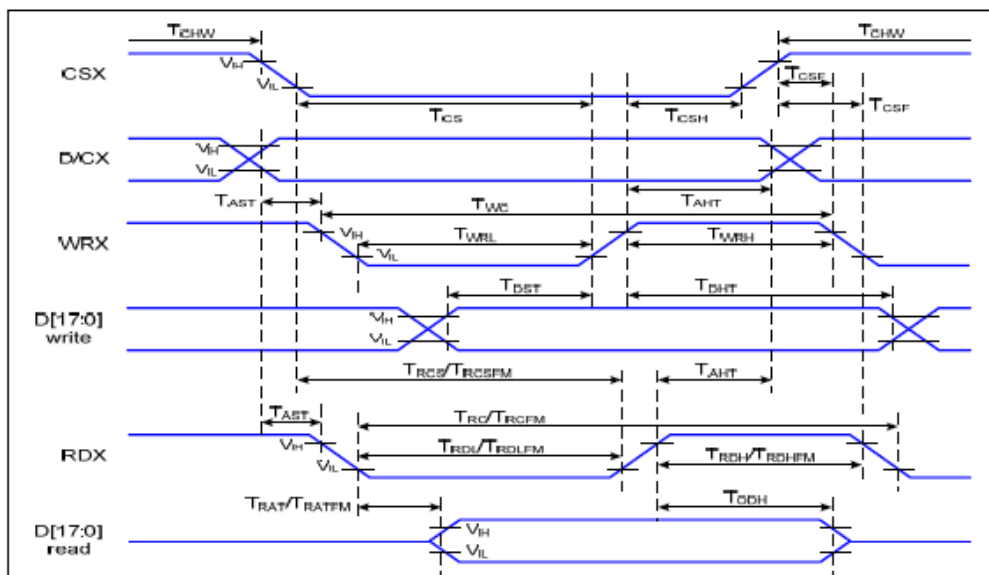

Figure 1 Parallel Interface Timing Characteristics (8080-Series MCU Interface)

VDDI=1.65 to 3.3V, VDD=2.4 to 3.3V, AGND=DGND=0V, Ta= -30 to 70 °C

Signal	Symbol	Parameter	Min	Max	Unit	Description
D/CX	T <sub>AST</sub>	Address setup time	0		ns	
	T <sub>AHT</sub>	Address hold time (Write/Read)	10		ns	
CSX	T <sub>CHW</sub>	Chip select "H" pulse width	0		ns	
	T <sub>CS</sub>	Chip select setup time (Write)	15		ns	
	T <sub>RCS</sub>	Chip select setup time (Read ID)	45		ns	
	T <sub>RCSFM</sub>	Chip select setup time (Read FM)	355		ns	
	T <sub>CSF</sub>	Chip select wait time (Write/Read)	10		ns	
	T <sub>CSH</sub>	Chip select hold time	10		ns	
WRX	T <sub>WC</sub>	Write cycle	66		ns	
	T <sub>WRH</sub>	Control pulse "H" duration	15		ns	
	T <sub>WRL</sub>	Control pulse "L" duration	15		ns	
RDX (ID)	T <sub>RC</sub>	Read cycle (ID)	160		ns	When read ID data
	T <sub>RDH</sub>	Control pulse "H" duration (ID)	90		ns	
	T <sub>RDL</sub>	Control pulse "L" duration (ID)	45		ns	
RDX (FM)	T <sub>RCFM</sub>	Read cycle (FM)	450		ns	When read from frame memory
	T <sub>RDHFM</sub>	Control pulse "H" duration (FM)	90		ns	
	T <sub>RDLFM</sub>	Control pulse "L" duration (FM)	355		ns	
D[17:0]	T <sub>DST</sub>	Data setup time	10		ns	For CL=30pF

$T_{DHT}$	Data hold time	10		ns
$T_{RAT}$	Read access time (ID)		40	ns
$T_{RATFM}$	Read access time (FM)		340	ns
$T_{ODH}$	Output disable time	20	80	ns

Table 4 8080 Parallel Interface Characteristics

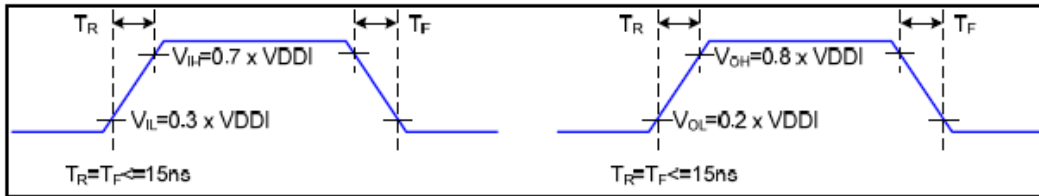

Figure 2 Rising and Falling Timing for I/O Signal

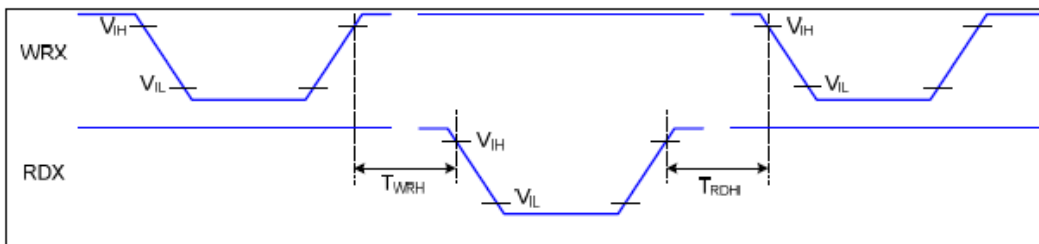
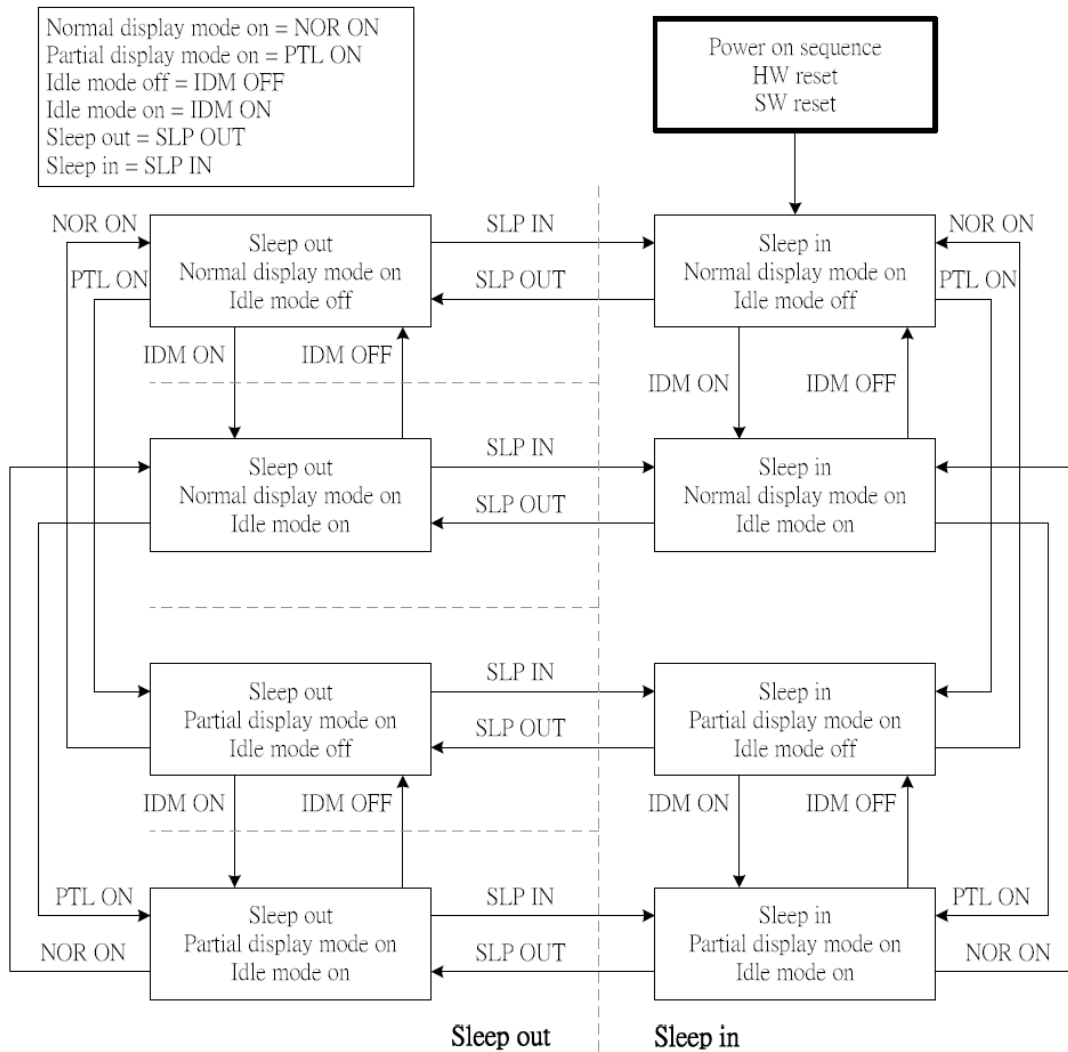

Figure 3 Write-to-Read and Read-to-Write Timing

Note: The rising time and falling time ( $T_r$ ,  $T_f$ ) of input signal and fall time are specified at 15 ns or less. Logic high and low levels are specified as 30% and 70% of VDDI for input signals.

## 9 SETUP FLOW OF POWER SUPPLY



## 10. RELIABILITY

Test Item	Test Conditions	Note
High Temperature Operation	70±3°C , t=240 hrs	
Low Temperature Operation	-20±3°C , t=240 hrs	
High Temperature Storage	80±3°C , t=240 hrs	1,2
Low Temperature Storage	-30±3°C , t=240 hrs	1,2
Storage Humidity Test	60°C , Humidity 90%, 240 hrs	1,2
Thermal Shock Test	-30°C ~ 25°C ~ 80°C 30 min. 5 min. 30 min. ( 1 cycle ) Total 5 cycle	1,2
Vibration Test (Packing)	Sweep frequency : 10~55~10 Hz/1min Amplitude : 0.75mm Test direction : X.Y.Z/3 axis Duration : 30min/each axis	2

Note 1 : Condensation of water is not permitted on the module.

Note 2 : The module should be inspected after 1 hour storage in normal conditions

(15-35°C , 45-65%RH).

Definitions of life end point :

- Current drain should be smaller than the specific value.
- Function of the module should be maintained.
- Appearance and display quality should not have degraded noticeably.
- Contrast ratio should be greater than 50% of the initial value.



## **11. USE PRECAUTIONS**

### **11.1 Handling precautions**

- 1) The polarizing plate may break easily so be careful when handling it. Do not touch, press or rub it with a hard-material tool like tweezers.
- 2) Do not touch the polarizing plate surface with bare hands so as not to make it dirty. If the surface or other related part of the polarizing plate is dirty, soak a soft cotton cloth or chamois leather in benzine and wipe off with it. Do not use chemical liquids such as acetone, toluene and isopropyl alcohol. Failure to do so may bring chemical reaction phenomena and deteriorations.
- 3) Remove any spit or water immediately. If it is left for hours, the suffered part may deform or decolorize.
- 4) If the LCD element breaks and any LC stuff leaks, do not suck or lick it. Also if LC stuff is stuck on your skin or clothing, wash thoroughly with soap and water immediately.

### **11.2 Installing precautions**

- 1) The PCB has many ICs that may be damaged easily by static electricity. To prevent breaking by static electricity from the human body and clothing, earth the human body properly using the high resistance and discharge static electricity during the operation. In this case, however, the resistance value should be approx.  $1M\Omega$  and the resistance should be placed near the human body rather than the ground surface. When the indoor space is dry, static electricity may occur easily so be careful. We recommend the indoor space should be kept with humidity of 60% or more. When a soldering iron or other similar tool is used for assembly, be sure to earth it.
- 2) When installing the module and ICs, do not bend or twist them. Failure to do so may crack LC element and cause circuit failure.
- 3) To protect LC element, especially polarizing plate, use a transparent protective plate (e.g., acrylic plate, glass etc) for the product case.
- 4) Do not use an adhesive like a both-side adhesive tape to make LCD surface (polarizing plate) and product case stick together. Failure to do so may cause the polarizing plate to peel off.

### **11.3 Storage precautions**

- 1) Avoid a high temperature and humidity area. Keep the temperature between 0°C and 35°C and also the humidity under 60%.
- 2) Choose the dark spaces where the product is not exposed to direct sunlight or fluorescent light.
- 3) Store the products as they are put in the boxes provided from us or in the same conditions as we recommend.

### **11.4 Operating precautions**

- 1) Do not boost the applied drive voltage abnormally. Failure to do so may break ICs. When applying power voltage, check the electrical features beforehand and be careful. Always turn off the power to the LC module controller before removing or inserting the LC module input connector. If the input connector is removed or inserted while the power is turned on, the LC module internal circuit may break.
- 2) The display response may be late if the operating temperature is under the normal standard, and the display may be out of order if it is above the normal standard. But this is not a failure; this will be restored if it is within the normal standard.
- 3) The LCD contrast varies depending on the visual angle, ambient temperature, power voltage etc. Obtain the optimum contrast by adjusting the LC drive voltage.
- 4) When carrying out the test, do not take the module out of the low-temperature space suddenly. Failure to do so will cause the module condensing, leading to malfunctions.
- 5) Make certain that each signal noise level is within the standard (L level: 0.2V<sub>dd</sub> or less and H level: 0.8V<sub>dd</sub> or more) even if the module has functioned properly. If it is beyond the standard, the module may often malfunction. In addition, always connect the module when making noise level measurements.
- 6) The CMOS ICs are incorporated in the module and the pull-up and pull-down function is not adopted for the input so avoid putting the input signal open while the power is ON.
- 7) The characteristic of the semiconductor element changes when it is exposed to light emissions, therefore ICs on the LCD may malfunction if they receive light emissions. To prevent these malfunctions, design and assemble ICs so that

they are shielded from light emissions.

- 8) Crosstalk occurs because of characteristics of the LCD. In general, crosstalk occurs when the regularized display is maintained. Also, crosstalk is affected by the LC drive voltage. Design the contents of the display, considering crosstalk.

### **11.5 Other**

- 1) Do not disassemble or take the LC module into pieces. The LC modules once disassembled or taken into pieces are not the guarantee articles.
- 2) The residual image may exist if the same display pattern is shown for hours. This residual image, however, disappears when another display pattern is shown or the drive is interrupted and left for a while. But this is not a problem on reliability.
- 3) AMIPRE will provide one year warrantee for all products and three months warrantee for all repairing products.

# 12 Mechanical Drawing

