



晶采光電科技股份有限公司  
AMPIRE CO., LTD.

# Specifications for LCD module

<b>Customer</b>	
<b>Customer part no.</b>	
<b>Ampire part no.</b>	<b>AM-12801024DTZQW-00</b>
<b>Approved by</b>	
<b>Date</b>	

Approved For Specifications



Approved For Specifications & Sample

AMPIRE CO., LTD.

4F., No.116, Sec. 1, Xintai 5th Rd., Xizhi Dist., New Taipei City221, Taiwan (R.O.C.)

新北市汐止區新台五路一段 116 號 4 樓(東方科學園區 A 棟)

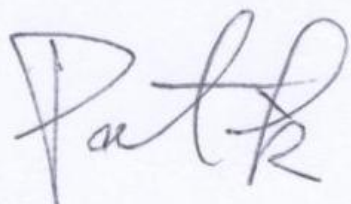
TEL:886-2-26967269 , FAX:886-2-26967196 or 26967270

Approved by	Checked by	Organized by
		

## RECORD OF REVISION

Revision Date	Page	Contents	Editor
2017/6/26	-	New Release	Jessica
2017/11/8	14	Update drawing	Jessica

## 1. Features

19" TFT Liquid Crystal Display module

LCD Resolution: 1280 RGB x 1024

LCD interface: 24 BIT Dual LVDS

Number of Color: 16M colors (R, G, B, 8 Bit digital each)

Brightness: 250cd/m<sup>2</sup>

## 2. PHYSICAL SPECIFICATIONS

Item	Specifications	Remark
LCD size	19.0 inch(Diagonal)	
Number of Pixels	1280(H) × 1024(V)	
Display mode	Normally Black	
Number of Colors	16.7M (6Bit+Hi-FRC)	
Pixel pitch	0.2928(W) × 0.2928(H)	
Active area	374.784(W) × 299.827 (H)	
Surface treatment	Anti-Glare, 3H	
Viewing Angle	89/89/89/89 (Deg.)	
Backlight	White LED	
Color arrangement	RGB vertical strip	

### 3. ABSOLUTE MAXIMUM RATINGS

ITEM	SYMBOL	VALUES		UNIT	REMARK
		MIN	MAX		
Power Voltage	V <sub>IN</sub>	-0.3	13	V	GND=0V, TA=25°C
Operation Temperature	T <sub>op</sub>	0	50	°C	
Storage Temperature	T <sub>st</sub>	-20	60	°C	

Note(1) The absolute maximum rating values of this product are not allowed to be exceeded at any times.

Note(2) Should a module be used with any of the absolute maximum ratings exceeded, the characteristics of the module may not be recovered, or in an extreme case, the module may be permanently destroyed.

## 4. ELECTRICAL CHARACTERISTICS

### 4-1 Typical Operation Conditions (HDMI Interface Board)

Item	Symbol	Min	Typ.	Max	Unit	Note
HDMI Interface Board Power Supply voltage	$V_{IN}$	11.5	12.0	12.5	V	
Power Consumption	$I_{VIN}$		T.B.D	--		

### 4-2 TFT-LCD

**It's for design reference only. These supply voltage and signals do not need to input by end user.**

ITEM	SYMBOL	MIN	TYP	MAX	UNIT	NOTE
LCD Power Voltage	VCC	4.5	5.0	5.5	V	
LCD Power Current	ICC	-	600	1100	mA	*1)
LCD Rush Current	VCC_Irush		2.0	3.0	A	*3)
Logic Input Voltage (LVDS: IN+,IN-)	Common Voltage	$\frac{ VID }{2}$	-	$\frac{ VID }{2}$	V	Logic Input Voltage
	Differential Input Voltage	$ VID $	200	600	mV	
	Threshold Voltage (HIGH)	VTH	-	100	mV	
	Threshold Voltage (LOW)	VTL	-100	-	mV	
Logic Input Voltage	VIH	0.7*DVDD	-	DVDD	V	Logic Input Voltage
	VIL	GND	-	0.3*DVDD	V	
Power consumption	PD		3	5.5	W	
	PBL	9.57	10.23	10.89	W	
	Ptotal	-	13.23	16.39	W	

Typ. specification : Gray-level test Pattern (TYP Freq. @5.0V)

MAX. specification : Black test Pattern (TYP Freq. @5.0V)



Gray-level Pattern



Black Pattern

LVDS Signal Definite :

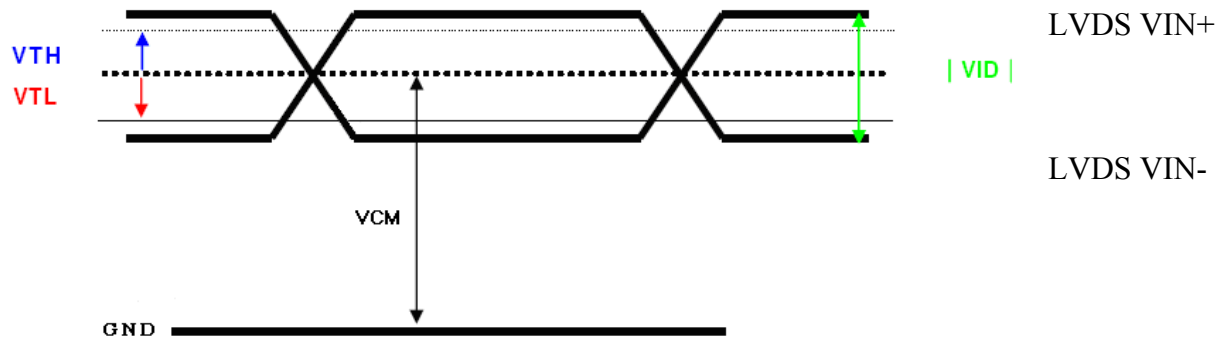

VIN+ : Positive differential DATA & CLK Input

VIN- : Negative differential DATA & CLK Input

Inrush measure condition

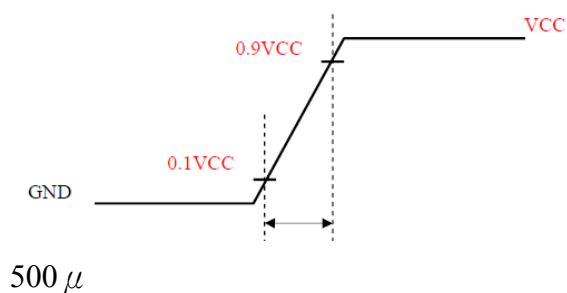
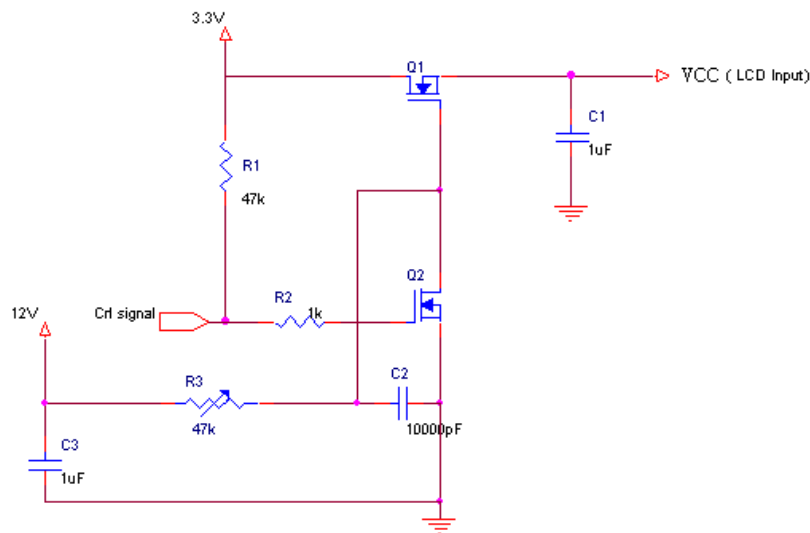

### 4-3 Backlight Unit

Ta=25°C

It's for design reference only. These supply voltage and signals do not need to input by end user.

Parameter		Min.	Typ.	Max.	Unit	Remarks
LED Light Bar Input Voltage Per Input Pin	VPIN	43.5	46.5	49.5	V	Duty 100%
LED Light Bar Input Current Per Input Pin	IPIN	-	110	-	mA	Note1,2,
LED Power Consumption	P <sub>BL</sub>	9.57	10.23	10.89	W	Note 3
LED Life-Time	-	30,000	-		Hrs	Note 4

Note1: There are one light bar ,and the specified current is input LED chip 100% duty current

Note2: The sense current of each input pin is 110mA

Note3:  $P_{BL}=2\text{Input pins} \times V_{PIN} \times I_{PIN}$

Note4: The lifetime is determined as the time at which luminance of LED become 50% of the initial brightness or not normal lighting at IPIN=110mA on condition of continuous operating at 25 ± 2 °C

## 5. INTERFACE PIN CONNECTION

Pin #	Signal Name	Description
1	RXO0-	Negative Transmission data of Pixel 0 (ODD)
2	RXO0+	Positive Transmission data of Pixel 0 (ODD)
3	RXO1-	Negative Transmission data of Pixel 1 (ODD)
4	RXO1+	Positive Transmission data of Pixel 1 (ODD)
5	RXO2-	Negative Transmission data of Pixel 2 (ODD)
6	RXO2+	Positive Transmission data of Pixel 2 (ODD)
7	GND	Ground
8	RXOC-	Negative Transmission Clock (ODD)
9	RXOC+	Positive Transmission Clock (ODD)
10	RXO3-	Negative Transmission data of Pixel 3 (ODD)
11	RXO3+	Positive Transmission data of Pixel 3 (ODD)
12	RXE0-	Negative Transmission data of Pixel 0 (EVEN)
13	RXE0+	Positive Transmission data of Pixel 0 (EVEN)
14	GND	Ground
15	RXE1-	Negative Transmission data of Pixel 1 (EVEN)
16	RXE1+	Positive Transmission data of Pixel 1 (EVEN)
17	GND	Ground
18	RXE2-	Negative Transmission data of Pixel 2 (EVEN)
19	RXE2+	Positive Transmission data of Pixel 2 (EVEN)
20	RXEC-	Negative Transmission Clock (EVEN)
21	RXEC+	Positive Transmission Clock (ODD)
22	RXE3-	Negative Transmission data of Pixel 3 (EVEN)
23	RXE3+	Positive Transmission data of Pixel 3 (EVEN)
24	GND	Ground
25	NC	No connection
26	NC	No connection
27	NC	No connection
28	VDD	Power supply
29	VDD	Power supply
30	VDD	Power supply



Pin No	Symbol	Description
1	IRLED1	LED current sense for string1
2	NC	No Connection
3	VLED	LED power supply
4	VLED	LED power supply
5	NC	No Connection
6	IRLED2	LED current sense for string2
7	CONNECTOR	3707K-S06N-00X

### Color Data Assignment

COLOR	INPUT DATA	R DATA								G DATA								B DATA							
		R7 MSB	R6	R5	R4	R3	R2	R1	R0 LSB	G7 MSB	G6	G5	G4	G3	G2	G1	G0 LSB	B7 MSB	B6	B5	B4	B3	B2	B1	B0 LSB
BASIC COLOR	BLACK	0	0	0	0	0	0	0	0	0	0	0	0	0	0	0	0	0	0	0	0	0	0	0	0
	RED(255)	1	1	1	1	1	1	1	1	0	0	0	0	0	0	0	0	0	0	0	0	0	0	0	
	GREEN(255)	0	0	0	0	0	0	0	0	1	1	1	1	1	1	1	1	0	0	0	0	0	0	0	
	BLUE(255)	0	0	0	0	0	0	0	0	0	0	0	0	0	0	0	0	1	1	1	1	1	1	1	
	CYAN	0	0	0	0	0	0	0	0	1	1	1	1	1	1	1	1	1	1	1	1	1	1	1	
	MAGENTA	1	1	1	1	1	1	1	1	0	0	0	0	0	0	0	0	1	1	1	1	1	1	1	
	YELLOW	1	1	1	1	1	1	1	1	1	1	1	1	1	1	1	1	0	0	0	0	0	0	0	
	WHITE	1	1	1	1	1	1	1	1	1	1	1	1	1	1	1	1	1	1	1	1	1	1	1	
RED	RED(0)	0	0	0	0	0	0	0	0	0	0	0	0	0	0	0	0	0	0	0	0	0	0	0	
	RED(1)	0	0	0	0	0	0	0	1	0	0	0	0	0	0	0	0	0	0	0	0	0	0	0	
	RED(2)	0	0	0	0	0	0	1	0	0	0	0	0	0	0	0	0	0	0	0	0	0	0	0	
	RED(254)	1	1	1	1	1	1	1	0	0	0	0	0	0	0	0	0	0	0	0	0	0	0	0	
	RED(255)	1	1	1	1	1	1	1	1	0	0	0	0	0	0	0	0	0	0	0	0	0	0	0	
GREEN	GREEN(0)	0	0	0	0	0	0	0	0	0	0	0	0	0	0	0	0	0	0	0	0	0	0	0	
	GREEN(1)	0	0	0	0	0	0	0	0	0	0	0	0	0	0	1	0	0	0	0	0	0	0	0	
	GREEN(2)	0	0	0	0	0	0	0	0	0	0	0	0	0	1	0	0	0	0	0	0	0	0		
	GREEN(254)	0	0	0	0	0	0	0	0	1	1	1	1	1	1	1	0	0	0	0	0	0	0	0	
	GREEN(255)	0	0	0	0	0	0	0	0	1	1	1	1	1	1	1	1	0	0	0	0	0	0	0	
BLUE	BLUE(0)	0	0	0	0	0	0	0	0	0	0	0	0	0	0	0	0	0	0	0	0	0	0	0	
	BLUE(1)	0	0	0	0	0	0	0	0	0	0	0	0	0	0	0	0	0	0	0	0	0	0	1	
	BLUE(2)	0	0	0	0	0	0	0	0	0	0	0	0	0	0	0	0	0	0	0	0	0	0	1	
	BLUE(254)	0	0	0	0	0	0	0	0	0	0	0	0	0	0	0	0	1	1	1	1	1	1	0	
	BLUE(255)	0	0	0	0	0	0	0	0	0	0	0	0	0	0	0	0	1	1	1	1	1	1	1	

Definition of gray scale:

Color (n): n indicates gray scale level; higher n means brighter level.

Data: 1-High, 0-Low.

This assignment is applied to both odd and even data.

## 6. OPTICAL CHARACTERISTICS

Parameter		Symbol	Condition	Min.	Typ.	Max.	Unit	Remark
Viewing Angle range	Horizontal	$\Theta_3$	CR > 10	85	89	-	Deg.	Note 1
		$\Theta_9$		85	89	-	Deg.	
	Vertical	$\Theta_{12}$		85	89	-	Deg.	
		$\Theta_6$		85	89	-	Deg.	
Luminance Contrast ratio		CR	$\Theta = 0^\circ$ (Center) Normal Viewing Angle	700	1000			Note 2
Luminance of White		$Y_w$		200	250		cd/m <sup>2</sup>	Note 3
White luminance uniformity		$\Delta Y$		75	-		%	Note 4
Reproduction of color	White	$W_x$		0.283	0.313	0.343	-	Note 5
		$W_y$		0.299	0.329	0.359	-	
	Red	$R_x$		0.602	0.632	0.662	-	
		$R_y$		0.322	0.352	0.382	-	
	Green	$G_x$		0.286	0.316	0.346	-	
		$G_y$		0.604	0.634	0.664	-	
	Blue	$B_x$		0.121	0.151	0.181	-	
		$B_y$	0.021	0.051	0.081	-		
Response Time	GTG	$T_g$		14	20	ms	Note 6	
	Rising	$T_r$		8	11	ms		
	Falling	$T_f$		8	11	ms		
Cross Talk		CT		-	-	2.0	%	Note 7

Note:

1. Viewing angle is the angle at which the contrast ratio is greater than 10. The viewing are determined for the horizontal or 3, 9 o'clock direction and the vertical or 6, 12 o'clock direction with respect to the optical axis which is normal to the LCD surface.
2. Contrast measurements shall be made at viewing angle of  $\theta = 0^\circ$  and at the center of the LCD surface. Luminance shall be measured with all pixels in the view field set first to white, then to the dark (black) state. (See FIGURE 1 shown in Appendix) Luminance Contrast Ratio (CR) is defined mathematically.

$$CR = \frac{\text{Luminance when displaying a white raster}}{\text{Luminance when displaying a black raster}}$$

3. Center Luminance of white is defined as the LCD surface. Luminance shall be measured with all pixels in the view field set first to white. This measurement shall be taken at the locations shown in FIGURE 2 for a total of the measurements per display.
4. The White luminance uniformity on LCD surface is then expressed as :  
 $\Delta Y = ( \text{Minimum Luminance of 9points} / \text{Maximum Luminance of 9points} ) * 100$   
 (See FIGURE 2 shown in Appendix).
5. The color chromaticity coordinates specified in Table 4. shall be calculated from the spectral data measured with all pixels first in red, green, blue and white. Measurements shall be made at the center of the panel.
6. Response time  $T_g$  is the average time required for display transition by switching the input signal as below table and is based on Frame rate  $fV = 60\text{Hz}$  to optimize.

Each time in below table is defined as Figure 3 and shall be measured by switching the signal for “any level of gray(bright)” and “any level of gray(dark)”. Response time  $T_r$  shall be measured by switching the signal from “0 level of gray” to “255 level of gray” in Figure 3. And response time  $T_f$  shall be measured by switching the signal from “255 level of gray” to “0 level of gray” in Figure 3.

Measured Response Time	Target																
	0	15	31	47	63	79	95	111	127	143	159	175	191	207	223	239	255
0																	
15																	
31																	
47																	
63																	
79																	
95																	
111																	
127																	
143																	
159																	
175																	
191																	
207																	
223																	
239																	
255																	

7. Cross-Talk of one area of the LCD surface by another shall be measured by comparing the luminance ( $Y_A$ ) of a 25mm diameter area, with all display pixels set to a gray level, to the luminance ( $Y_B$ ) of that same area when any adjacent area is driven dark. (See FIGURE 4 shown in Appendix).

## 7. RELIABILITY TEST CONDITIONS

Test Item	Test Conditions	Note
High Temperature Operation	50±3°C ,Dry t=240 hrs	
Low Temperature Operation	0±3°C, Dry t=240 hrs	
High Temperature Storage	60±3°C , Dry t=240 hrs	1,2
Low Temperature Storage	-20±3°C ,Dry t=240 hrs	1,2
Thermal Shock Test	-20°C ~ 25°C ~ 60°C 30 m in. 5 min. 30 min. ( 1 cycle ) Total 100 cycle(Dry)	1,2
Storage Humidity Test	50 °C, Humidity 80%, 240 hrs	1,2
Vibration Test (Packing)	Sweep frequency : 10 ~ 55 ~ 10 Hz/1min Amplitude : 0.75mm Test direction : X.Y.Z/3 axis Duration : 30min/each axis	2

Condensation of water is not permitted on the module.

The module should be inspected after 1 hour storage in normal conditions  
(15-35°C, 45-65%RH)

Definitions of life end point:

- Current drain should be smaller than the specific value.
- Function of the module should be maintained.
- Appearance and display quality should not have degraded noticeably.
- Contrast ratio should be greater than 50% of the initial value.

# 8. OUTLINE DIMENSION

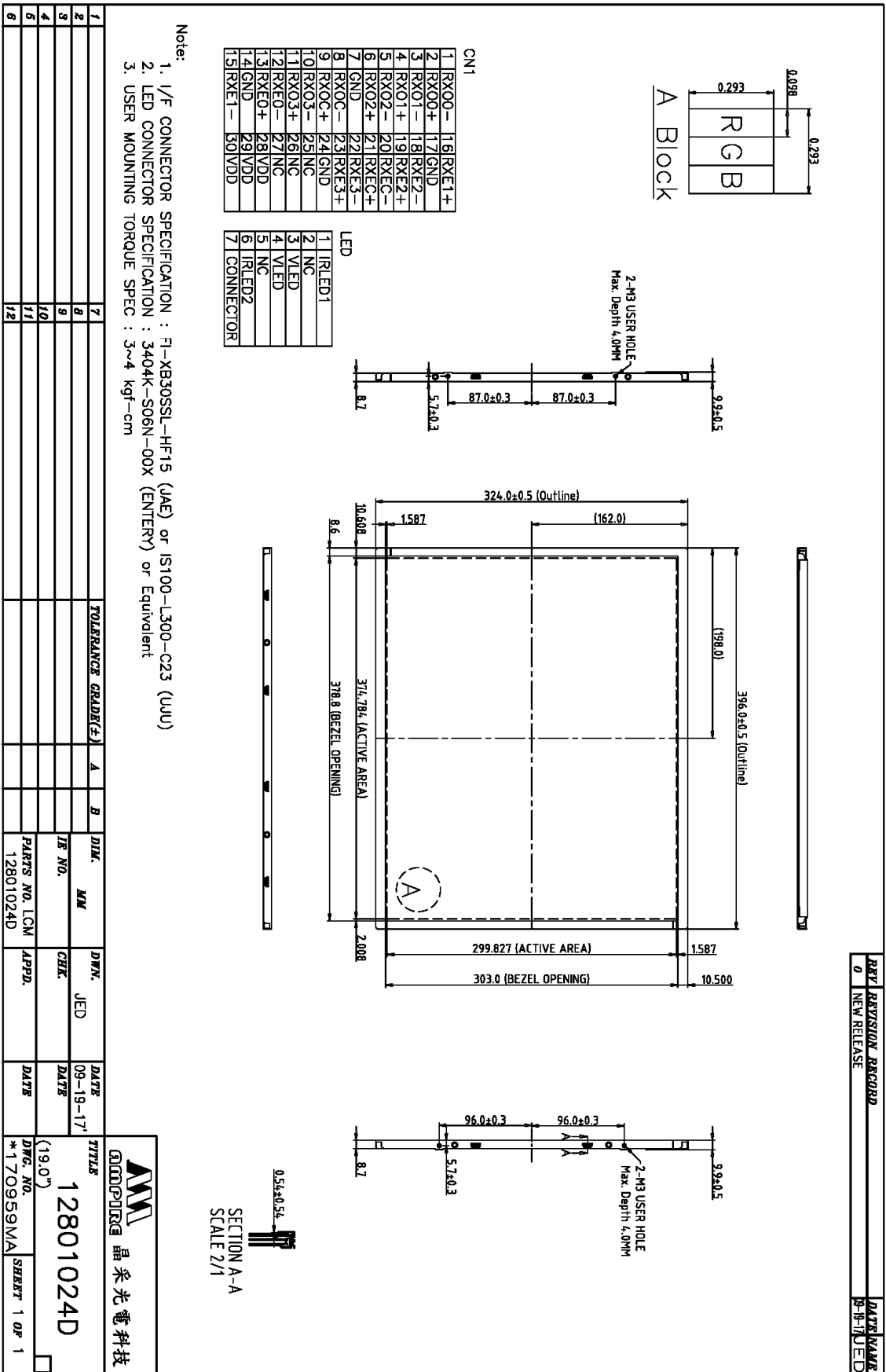

REV	REVISION RECORD	DATE	NAME
0	NEW RELEASE	09-19-17	JED
1	Modify connect	11-08-17	JED

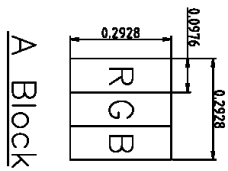
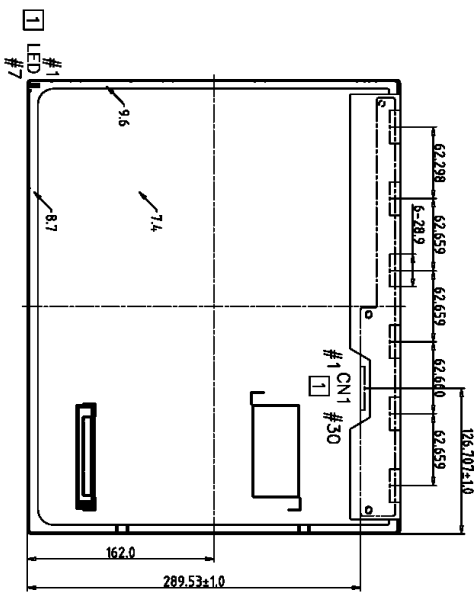

CN1	
1	RX00- 16/RXE1+
2	RX00+ 17/GND
3	RX01- 18/RXE2-
4	RX01+ 19/RXE2+
5	RX02- 20/RXEC-
6	RX02+ 21/RXEC+
7	GND 22/RXE3-
8	RX0C- 23/RXE3+
9	RX0C+ 24/GND
10	RX03- 25/NC
11	RX03+ 26/NC
12	RXE0- 27/NC
13	RXE0+ 28/VDD
14	GND 29/VDD
15	RXE1- 30/VDD

LED	
1	IRLED1
2	NC
3	VLED
4	VLED
5	NC
6	IRLED2
7	CONNECTOR

Back view

- Note:
1. I/F CONNECTOR SPECIFICATION : F1-XB30SSL-HF15 (JAE) or IS100-L300-C23 (JUI)
  2. LED CONNECTOR SPECIFICATION : 3404K-S06N-00X (ENTERY) or Equivalent
  3. USER MOUNTING TORQUE SPEC : 3~4 kgf-cm

1	2	TOLERANCE GRADE	A	B	DIM.	MIN	DIM.	JED	DATE	TITLE
3	9				IE NO.		CHEC.		DATE	12801024D
4	10				PARTS NO	12801024D	APPD.		DATE	(19.0")
5	11								DATE	DWG. NO. *170960MB
6	12								DATE	SHEET 1 OF 1

AMPIRE 晶采光电科技