



晶采光電科技股份有限公司  
AMPIRE CO., LTD.

## SPECIFICATIONS FOR LCD MODULE

<b>CUSTOMER</b>	
<b>CUSTOMER PART NO.</b>	
<b>AMPIRE PART NO.</b>	AM-1024768X1TZQW-A0
<b>APPROVED BY</b>	
<b>DATE</b>	

Approved For Specifications

Approved For Specifications & Sample

**AMPIRE CO., LTD.**

**Building A., 4F., No.116, Sec. 1, Sintai 5th Rd., Xizhi Dist,  
New Taipei City 221, Taiwan (R.O.C.)**

**新北市汐止區新台五路一段 116 號 4 樓(東方科學園區 A 棟)**

**TEL:886-2-26967269 , FAX:886-2-26967196 or 26967270**

APPROVED BY	CHECKED BY	ORGANIZED BY

## RECORD OF REVISION

Revision Date	Page	Contents	Editor
2016/04/26	-	New Release	Lawlite
2017/02/07	3	Features	Lawlite
	6	Update LVDS input data format	Lawlite
	10	Interface pin17,18 function	

## 1. INSTRUCTION

AM-1024768X1TZQW-A0 is 9.7" color TFT-LCD (Thin Film Transistor Liquid Crystal Display) module composed of LCD panel, driver ICs, control circuit and backlight. The 9.7" screen produces a high resolution image that is composed of 1024×768 pixel elements in a stripe arrangement.

### 1-1. Features

- 9.7" (diagonal) configuration
- Input interface voltage : 3.3V
- LCD type : Transmissive , Normally Black
- LVDS Interface
- 6-Bit Mode Only
- Build-in LED driver IC (12V)

### 1-2. Applications

- Portable TV

## 2. PHYSICAL SPECIFICATIONS

Item	Specifications	unit
Display resolution(dot)	1024RGB (W) x 768(H)	dots
Active area	196.608 (W) x 147.456(H)	mm
Pixel pitch	0.192 (W) x 0.192 (H)	mm
Color configuration	R.G.B Vertical stripe	-
Overall dimension	243.0(W) x 185.6(H) x 7.2(D)	mm
Display Mode	IPS	-
Display color	262K	color
Backlight unit	LED	-

### 3.ELECTRICAL CHARACTERISTICS

#### 3-1 Electrical Absolute Rating

Item	Symbol	Values		UNIT	Note
		Min.	Max.		
Power voltage	V <sub>DD</sub>	-0.3	4.0	V	GND=0V
Voltage range at any terminal	-	-0.3	V <sub>DD</sub> +0.3	V	

#### 3-2 Environment Absolute Rating

Item	Symbol	Min.	Max.	Unit	Note
Operating Temperature	Topa	-20	65	°C	
Storage Temperature	Tstg	-20	65	°C	

#### 3-3 ELECTRICAL CHARACTERISTICS

Item	Symbol	Min	Typ	Max	Unit	Note
Power Voltage	V <sub>DD</sub>	-	3.3	-	V	
Differential Input High Threshold	V <sub>TH</sub>	-	-	0.1	V	
Differential Input Low Threshold	V <sub>TL</sub>	-0.1	-	-	V	
LED Power Voltage	V <sub>CC</sub>	-	12	-	V	
EN High Level	V <sub>IH</sub>	2.4	-	-	V	
EN Low Level	V <sub>IL</sub>	-	-	0.7	V	
PWM Input High Level	V <sub>PWMH</sub>	2.4	-	5	V	
PWM Input Low Level	V <sub>PWML</sub>	0	-	0.7	V	

### 3-4 Switching Characteristics of LVDS Receiver

Item	Symbol	Min.	Typ.	Max.	Unit	Condition
Differential Input High Threshold	VTH	--	--	100	mV	VCM=1.2V
Differential Input Low Threshold	VTL	-100	--	--	mV	
Input current	IIN	-10	--	+10	uA	
Differential input Voltage	VID	0.2	--	0.6	V	
Common Mode Voltage Offset	VCM	$\frac{ VID }{2}$	1.25	$2.4 - \frac{ VID }{2}$	V	

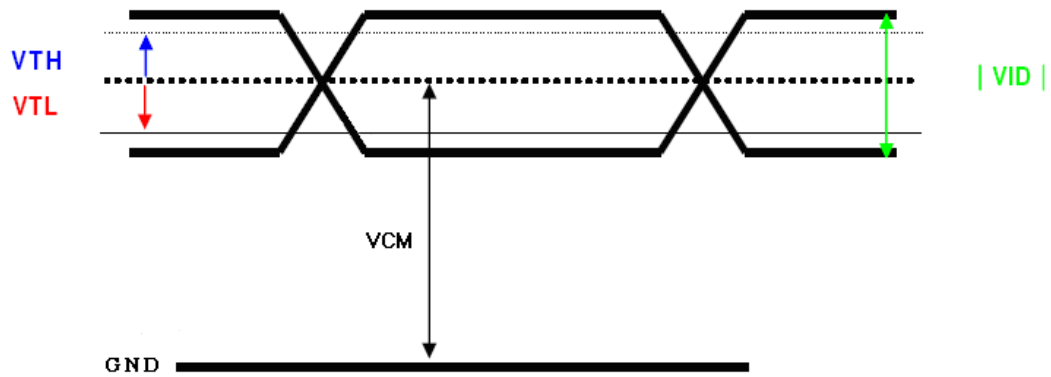

### 3-5 18-BIT LVDS Input Data Format

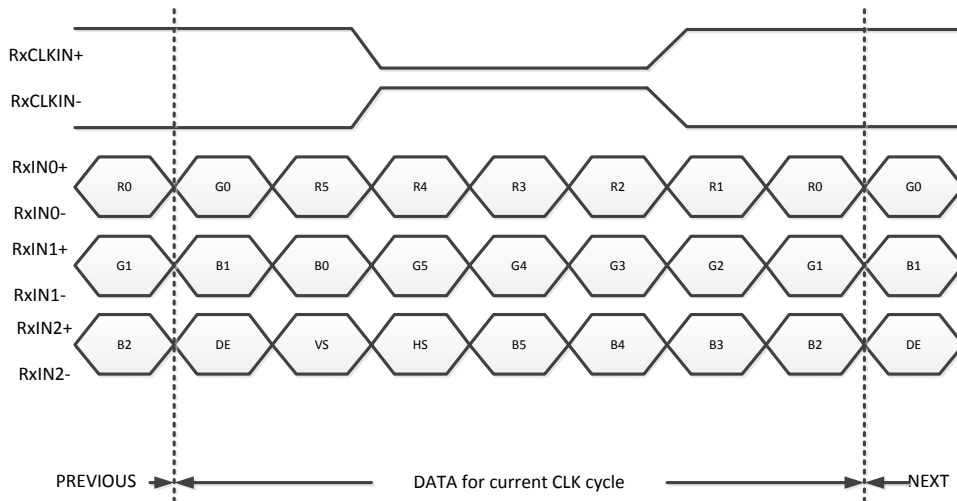

Note : R/G/B data 6 : MSB, R/G/B data 0 : LSB

Signal Name	Description	Remark
R5 R4 R3 R2 R1 R0	Red Data 5 (MSB) Red Data 4 Red Data 3 Red Data 2 Red Data 1 Red Data 0 (LSB)	Red-pixel Data Each red pixel's brightness data consists of these 6 bits pixel data.
G5 G4 G3 G2 G1 G0	Green Date 5 (MSB) Green Date 4 Green Date 3 Green Date 2 Green Date 1 Green Date 0 (LSB)	Green-pixel Data Each green pixel's brightness data consists of these 6 bits pixel data.
B5 B4 B3 B2 B1 B0	Blue Data 5(MSB) Blue Data 4 Blue Data 3 Blue Data 2 Blue Data 1 Blue Data 0 (LSB)	Blue-pixel Data Each blue pixel's brightness data consists of these 6 bits pixel data.

## 4. OPTICAL CHARACTERISTICS

Item	Symbol	Conditions	Min	Typ	Max	Unit	Note	
Contrast Ration	CR	Viewing normal angle	-	900	-	-		
Response Time	$T_{R+T_F}$	$\theta_x = \theta_y = 0$	-	20	-	ms	(2)	
Viewing Angle	Hor.	$\theta_{x+}$	Center CR>10	-	85	-	deg	(3)
		$\theta_{x-}$		-	85	-	deg	
	Ver.	$\theta_{y+}$		-	85	-	deg	
		$\theta_{y-}$		-	85	-	deg	
Module Chromaticity	Red	$X_R$	Viewing normal angle $\theta_x = \theta_y = 0$	0.566	0.616	0.666		
		$Y_R$		0.279	0.329	0.379		
	Green	$X_G$		0.235	0.285	0.335		
		$Y_G$		0.495	0.545	0.595		
	Blue	$X_B$		0.089	0.139	0.189		
		$Y_B$		0.086	0.156	0.206		
	White	$X_W$		0.256	0.296	0.356		
		$Y_W$		0.316	0.366	0.416		
Brightness	-	-	-	500	-	Cd/m <sup>2</sup>	(4)	

\*Note(1) These items are measured by BM-7 in the dark room (no ambient light)

\*Note(2) Definition of Response Time ( $T_R, T_F$ ):

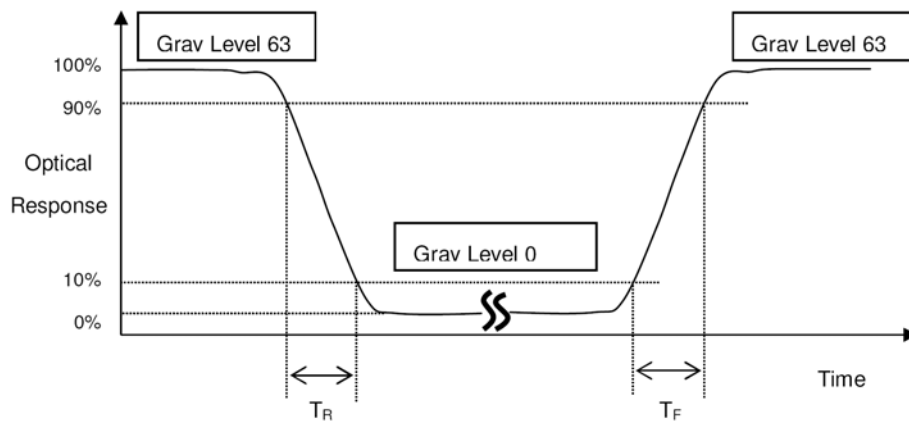

\*Note(3) Definition of Viewing Angle

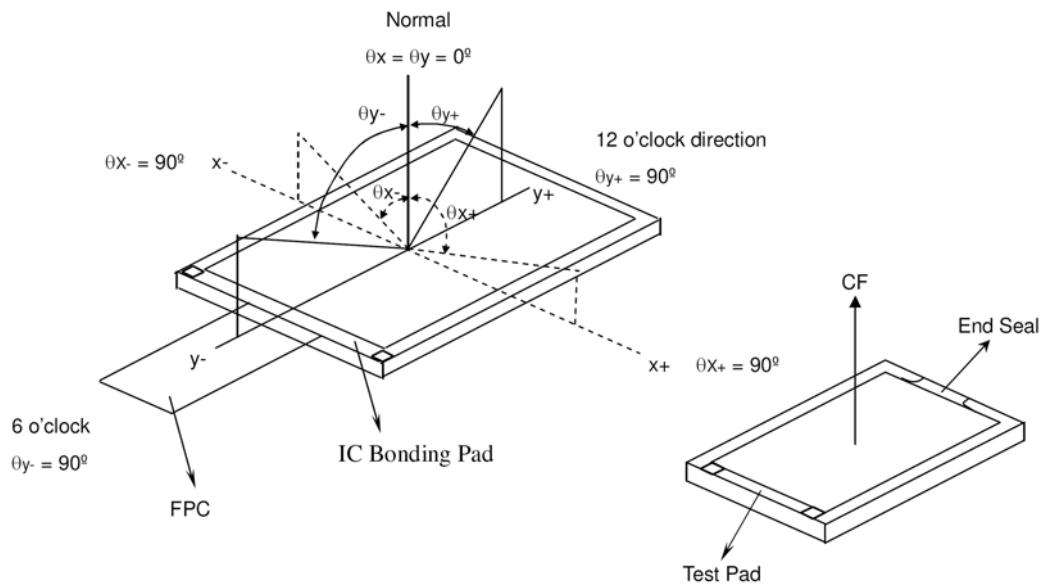

\*Note(4) The Brightness is the Test Point (5) which at the center of V.A.

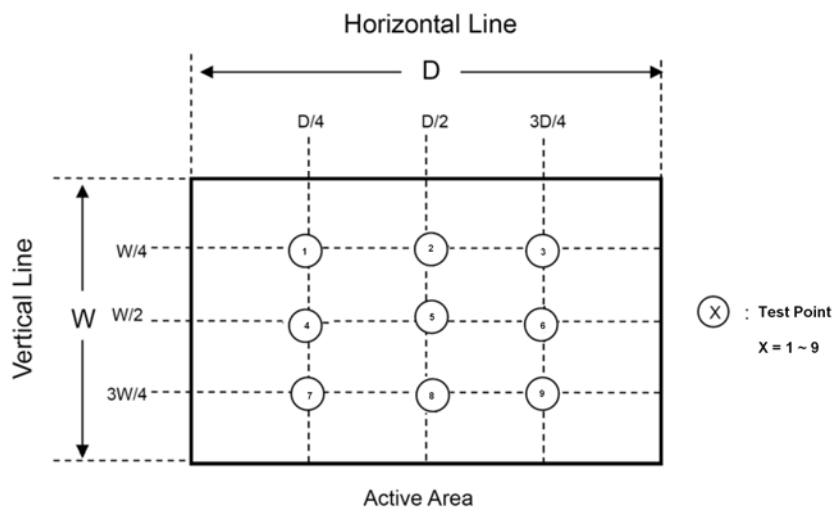



## 5. Backlight Driving Circuit

Item	Symbol	Min.	Typ.	Max.	Unit	Note
LED Forward Current	IF	--	300	--	mA	Ta=25°C
LED Forward Voltage	VF		18		V	Note (1)
LED Life time			30000		Hours	Note(2)

Note (1) The constant current source is needed for white LED back-light driving.

Note (2) Brightness to be decreased to 50% of the initial value.

### PWM Dimming Control

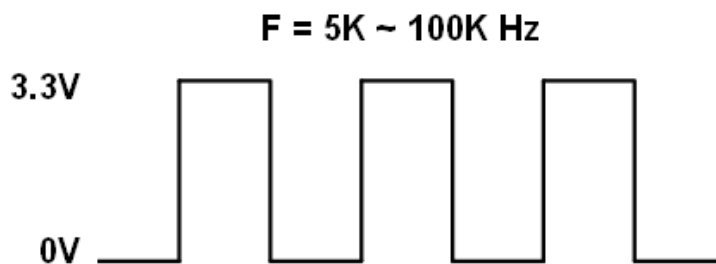
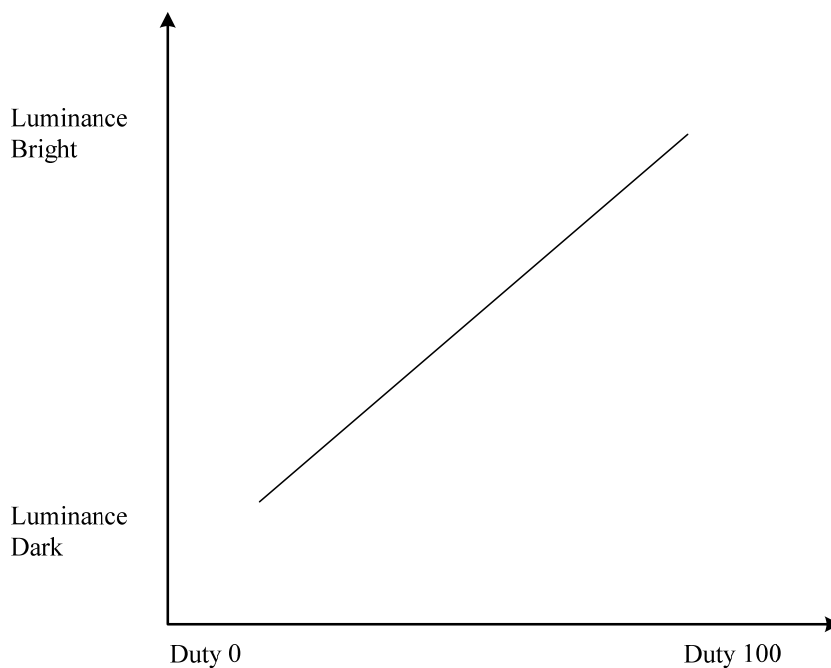

## 6. INTERFACE

### CN1 : LCM PIN Definition

Pin no	Symbol	Function
1	VDD	Power Supply:3.3V
2	VDD	Power Supply:3.3V
3	GND	Power Ground
4	DPS	Reverse Scan Function [H:Enable ; L:Disable]
5	RxIN0-	Transmission Data of Pixels 0
6	RxIN0+	Transmission Data of Pixels 0
7	GND	Power Ground
8	RxIN1-	Transmission Data of Pixels 1
9	RxIN1+	Transmission Data of Pixels 1
10	GND	Power Ground
11	RxIN2-	Transmission Data of Pixels 2
12	RxIN2+	Transmission Data of Pixels 2
13	GND	Power Ground
14	RxCLKIN-	LVDS receiver signal clock
15	RxCLKIN+	LVDS receiver signal clock
16	GND	Power Ground
17	RxIN3-	No Connection(no support 24 bit)
18	RxIN3+	No Connection(no support 24 bit)
19	GND	Power Ground()
20	GND	Power Ground

### CN2 : Backlight adjustment PIN Definition

Pin no	Symbol	Function
1	VCC	Power Supply
2	GND	Power Ground
3	ON/OFF	Function selection
4	Dimming	Adjust brightness
5	NA	No Connection

### CN4 : Backlight Power Source PIN Definition

Pin no	Symbol	Function
1	A	LED anode
2	K	LED cathode

## 7. Reliability Test Items

Test Item	Test Conditions	Note
High Temperature Operation	65±3°C , t=240 hrs	
Low Temperature Operation	-20±3°C , t=240 hrs	
High Temperature Storage	65±3°C , t=240 hrs	1,2
Low Temperature Storage	-20±3°C , t=240 hrs	1,2

Note 1 : Condensation of water is not permitted on the module.

Note 2 : The module should be inspected after 1 hour storage in normal conditions (15-35°C , 45-65%RH).

Definitions of life end point :

- Current drain should be smaller than the specific value.
- Function of the module should be maintained.
- Appearance and display quality should not have degraded noticeably.
- Contrast ratio should be greater than 50% of the initial value.

## **8. USE PRECAUTIONS**

### **8.1 Handling precautions**

- 1) The polarizing plate may break easily so be careful when handling it. Do not touch, press or rub it with a hard-material tool like tweezers.
- 2) Do not touch the polarizing plate surface with bare hands so as not to make it dirty. If the surface or other related part of the polarizing plate is dirty, soak a soft cotton cloth or chamois leather in benzene and wipe off with it. Do not use chemical liquids such as acetone, toluene and isopropyl alcohol. Failure to do so may bring chemical reaction phenomena and deteriorations.
- 3) Remove any spit or water immediately. If it is left for hours, the suffered part may deform or decolorize.
- 4) If the LCD element breaks and any LC stuff leaks, do not suck or lick it. Also if LC stuff is stuck on your skin or clothing, wash thoroughly with soap and water immediately.

### **8.2 Installing precautions**

- 1) The PCB has many ICs that may be damaged easily by static electricity. To prevent breaking by static electricity from the human body and clothing, earth the human body properly using the high resistance and discharge static electricity during the operation. In this case, however, the resistance value should be approx.  $1M\Omega$  and the resistance should be placed near the human body rather than the ground surface. When the indoor space is dry, static electricity may occur easily so be careful. We recommend the indoor space should be kept with humidity of 60% or more. When a soldering iron or other similar tool is used for assembly, be sure to earth it.
- 2) When installing the module and ICs, do not bend or twist them. Failure to do so may crack LC element and cause circuit failure.
- 3) To protect LC element, especially polarizing plate, use a transparent protective plate (e.g., acrylic plate, glass etc) for the product case.
- 4) Do not use an adhesive like a both-side adhesive tape to make LCD surface (polarizing plate) and product case stick together. Failure to do so may cause the polarizing plate to peel off.

### **8.3 Storage precautions**

- 1) Avoid a high temperature and humidity area. Keep the temperature between  $0^{\circ}\text{C}$  and  $35^{\circ}\text{C}$  and also the humidity under 60%.
- 2) Choose the dark spaces where the product is not exposed to direct sunlight or fluorescent light.
- 3) Store the products as they are put in the boxes provided from us or in the same conditions as we recommend.

## 8.4 Operating precautions

- 1) Do not boost the applied drive voltage abnormally. Failure to do so may break ICs. When applying power voltage, check the electrical features beforehand and be careful. Always turn off the power to the LC module controller before removing or inserting the LC module input connector. If the input connector is removed or inserted while the power is turned on, the LC module internal circuit may break.
- 2) The display response may be late if the operating temperature is under the normal standard, and the display may be out of order if it is above the normal standard. But this is not a failure; this will be restored if it is within the normal standard.
- 3) The LCD contrast varies depending on the visual angle, ambient temperature, power voltage etc. Obtain the optimum contrast by adjusting the LC drive voltage.
- 4) When carrying out the test, do not take the module out of the low-temperature space suddenly. Failure to do so will cause the module condensing, leading to malfunctions.
- 5) Make certain that each signal noise level is within the standard (L level:  $0.2V_{dd}$  or less and H level:  $0.8V_{dd}$  or more) even if the module has functioned properly. If it is beyond the standard, the module may often malfunction. In addition, always connect the module when making noise level measurements.
- 6) The CMOS ICs are incorporated in the module and the pull-up and pull-down function is not adopted for the input so avoid putting the input signal open while the power is ON.
- 7) The characteristic of the semiconductor element changes when it is exposed to light emissions, therefore ICs on the LCD may malfunction if they receive light emissions. To prevent these malfunctions, design and assemble ICs so that they are shielded from light emissions.
- 8) Crosstalk occurs because of characteristics of the LCD. In general, crosstalk occurs when the regularized display is maintained. Also, crosstalk is affected by the LC drive voltage. Design the contents of the display, considering crosstalk.

## 8.5 Other

- 1) Do not disassemble or take the LC module into pieces. The LC modules once disassembled or taken into pieces are not the guarantee articles.
- 2) The residual image may exist if the same display pattern is shown for hours. This residual image, however, disappears when another display pattern is shown or the drive is interrupted and left for a while. But this is not a problem on reliability.
- 3) AMIPRE will provide one year warranty for all products and three months warrantee for all repairing products.

# 9. OUTLINE DIMENSION

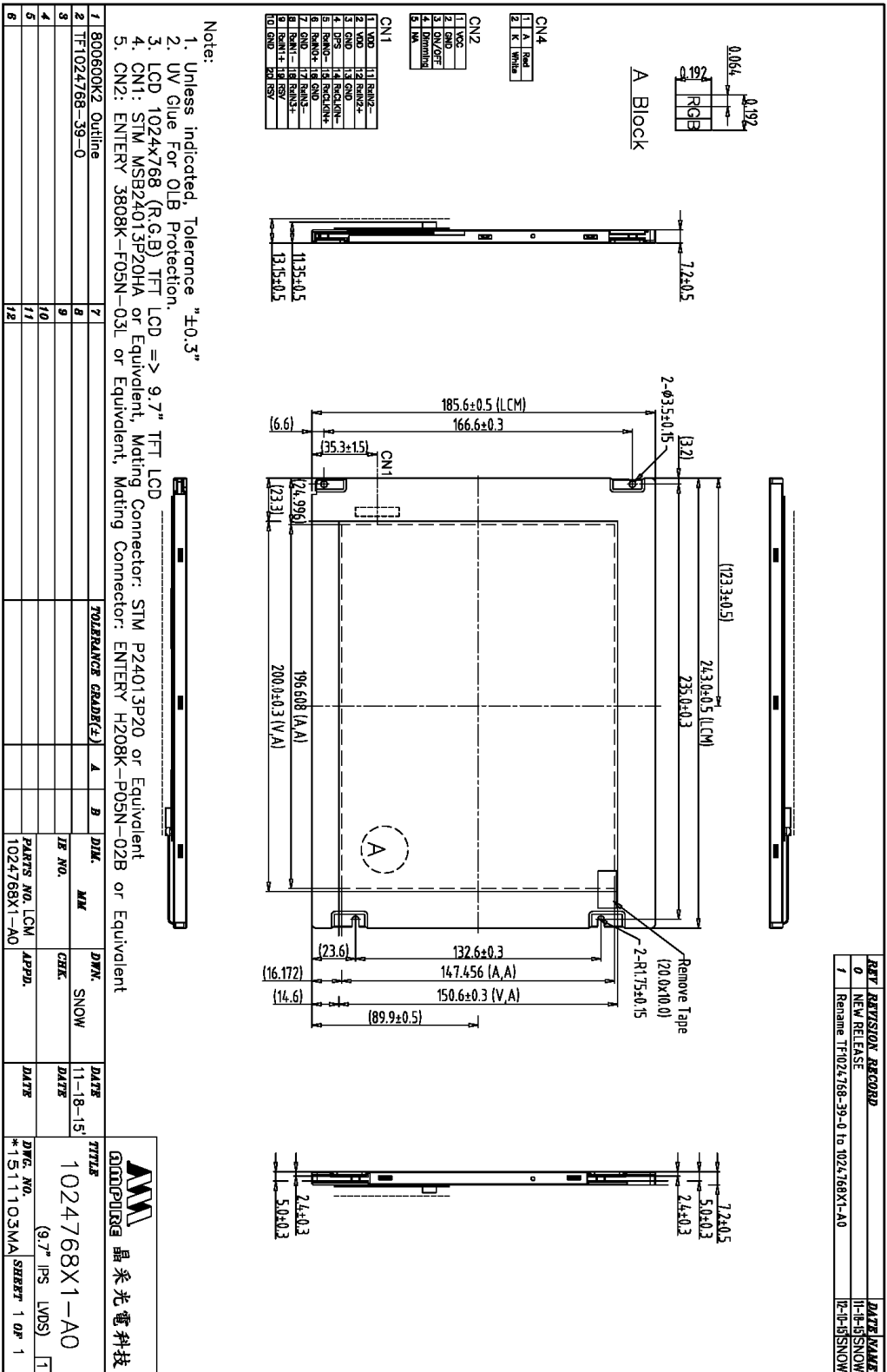

PART REVISION RECORD		DATE NAME
0	NEW RELEASE	11-18-15 SNOW
1	Rename TF1024768-39-0 to 1024768X1-A0	12-14-15 SNOW

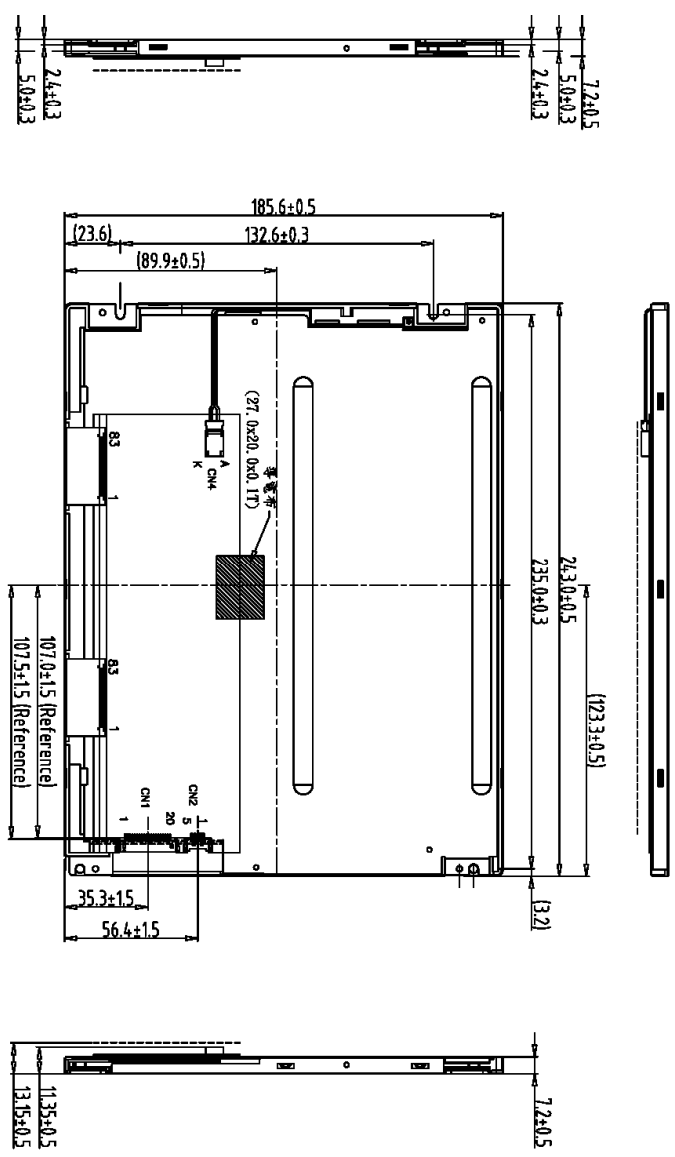

CN4

1	A	Red
2	K	White

CN2

1	RGB
2	AVD/DE
3	AVD/DE
4	AVD/DE
5	AVD/DE

CN1

1	VND	11	Red	-
2	VND	12	Red	+
3	VND	13	Red	+
4	VND	14	Red	+
5	VND	15	Red	+
6	VND	16	Red	+
7	VND	17	Red	+
8	VND	18	Red	+
9	VND	19	Red	+
10	VND	20	Red	+

Note:  
 1. Unless indicated, Tolerance "±0.3"  
 2. UV Glue For OLB Protection.  
 3. LCD 1024x768 (R.G.B) TFT LCD =>9.7" TFT LCD  
 4. CN1: STM MSB24013P20HA or Equivalent, Mating Connector: STM P24013P20 or Equivalent  
 5. CN2: ENTERY 3808K-F05N-03L or Equivalent, Mating Connector: ENTERY H208K-F05N-02B or Equivalent

REV	DESCRIPTION	DATE	BY	CHK	APP	DATE	BY	CHK	APP
1	800600K2 Outline	11-18-15							
2	TF1024768-39-0								
3									
4									
5									
6									

晶采光电科技  
 1024768X1-A0  
 (9.7" IPS LVDS)  
 DWG. NO. \*1511104MA SHEET 1 OF 1