



晶采光電科技股份有限公司
AMPIRE CO., LTD.

SPECIFICATIONS FOR LCD MODULE

CUSTOMER	
CUSTOMER PART NO.	
AMPIRE PART NO.	AM-1024600ATMQW-H6H
APPROVED BY	
DATE	

- Approved For Specifications
 Approved For Specifications & Sample

AMPIRE CO., LTD.
4F., No.116, Sec. 1, Xintai 5th Rd., Xizhi Dist., New Taipei
City221, Taiwan (R.O.C.)
新北市汐止區新台五路一段 116 號 4 樓(東方科學園區 A 棟)

APPROVED BY	CHECKED BY	ORGANIZED BY

RECORD OF REVISION

Revision Date	Page	Contents	Editor
2017/06/15	-	New Release	Kokai

CONFIDENTIAL

1. Features

The TFT LCD module Kit include

1. 7" TFT Liquid Crystal Display module with Capacitive touch panel.
 - LCD Resolution : 1024 x RGB x 600
 - Number of Color : 16M colors (R,G,B 8 Bit digital each)
 - Built-in LED Back-light driver.
 - Brightness :1000 cd/m²
2. HDMI to LCD interface board
 - Single Power input: 12V / 2A power input. (Connector: PJ2).
 - HDMI Digital input : (Connector: HDMI1)
 - ◆ HDMI 1.4a Compliant
 - ◆ Single-link (Type A HDMI) on-chip TMDS receiver up to 225MHz. Support long cable.
 - ◆ Do not support HDCP.
 - Support input video format :

3. Resolution	V Sync	Resolution	V Sync
640x480	60	1280x800	60
640x480	72	1280x800	75
640x480	75	1280x960	60
800x600	56	1280x1024	60
800x600	60	1280x1024	75
800x600	72	1360x768	60
800x600	75	1366x768	60
848x480	60	1400x1050	60
1024x768	60	1400x1050	75
1024x768	70	1440x900	60
1024x768	75	1440x900	75
1152x864	75	1600x900	60
1280x720	60	1680x1050	60
1280x768	60	1680x1050	75
1280x768	75	1920x1080	60

2. TFT LCD Module PHYSICAL SPECIFICATIONS

Item	Specifications	unit
LCD size	7 inch (Diagonal)	
Resolution	1024 x (RGB) x 600	dot
Pixel pitch	0.15 (W) x 0.1444(H)	mm
Active area	153.6(W) x 86.64(H)	mm
Module size	164.9(W) x 100.0(H) x21.3(D)	mm
Color arrangement	RGB-stripe	

CONFIDENTIAL

3. ABSOLUTE MAXIMUM RATINGS

ITEM	SYMBOL	VALUES		UNIT	REMARK
		MIN	MAX		
Power Voltage	V _{IN}	-0.3	13	V	GND=0V, TA=25°C
Operation Temperature	T _{op}	-20	70	°C	
Storage Temperature	T _{st}	-30	80	°C	

Note 1: The absolute maximum rating values of this product are not allowed to be exceeded at any times.

Should a module be used with any of the absolute maximum ratings exceeded, the characteristics of the module may not be recovered, or in an extreme case, the module may be permanently destroyed.

CONFIDENTIAL

4. ELECTRICAL SPECIFICATIONS

4.1 Typical Operation Conditions (HDMI Interface Board)

Item	Symbol	Min	Typ	Max	Unit	Note
HDMI Interface Board Power Supply voltage	V_{IN}	11.5	12.0	12.5	V	
Power Consumption	I_{VIN}		T.B.D	1A		

4.2 Typical Operation Conditions (TFT LCD Module)

For Design reference only. These supply voltage and signals do not need to input by end user.

Item	Symbol	Min.	Typ.	Max.	Unit	Condition
Digital Power Supply Voltage	VDD	3.0	3.3	3.6	V	
Digital Power Supply Current	IDD		105		mA	
Differential Input High Threshold	VTH	--	--	100	mV	VCM=1.2V
Differential Input Low Threshold	VTL	-100	--	--	mV	
Input current	IIN	-10	--	+10	uA	
Differential input Voltage	VID	0.2	--	0.6	V	
Common Mode Voltage Offset	VCM	$\frac{ VID }{2}$	1.25	$2.4 - \frac{ VID }{2}$	V	

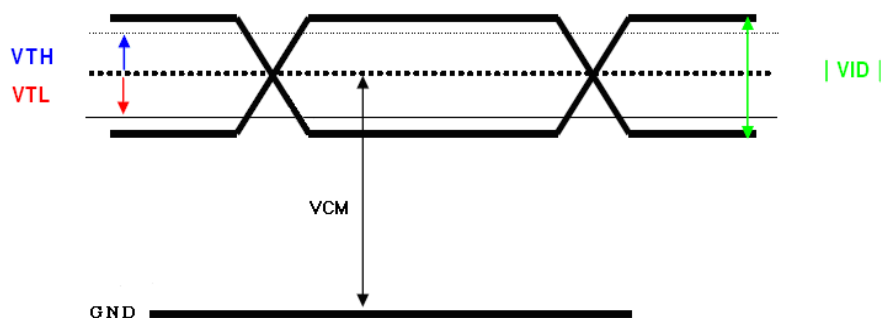

4.2.1 24-BIT LVDS Input Data Format

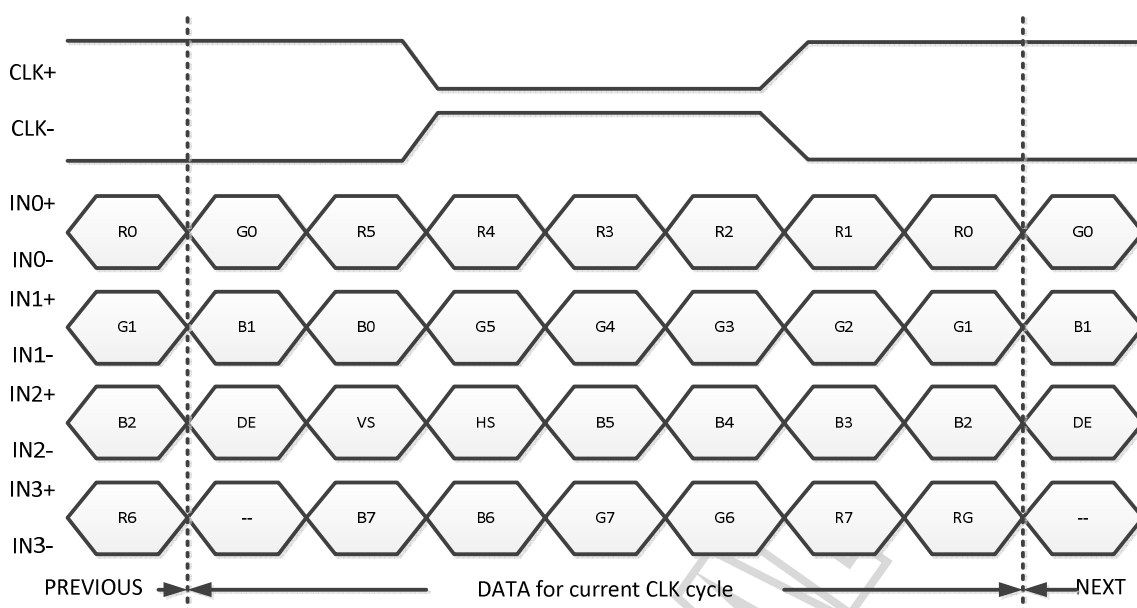

Note: R/G/B data 7: MSB, R/G/B data 0: LSB

Signal Name	Description	Remark
R7 R6 R5 R4 R3 R2 R1 R0	Red Data 7 (MSB) Red Data 6 Red Data 5 Red Data 4 Red Data 3 Red Data 2 Red Data 1 Red Data 0 (LSB)	Red-pixel Data Each red pixel's brightness data consists of these 8 bits pixel data.
G7 G6 G5 G4 G3 G2 G1 G0	Green Date 7 (MSB) Green Date 6 Green Date 5 Green Date 4 Green Date 3 Green Date 2 Green Date 1 Green Date 0 (LSB)	Green-pixel Data Each green pixel's brightness data consists of these 8 bits pixel data.
B7 B6 B5 B4 B3 B2 B1 B0	Blue Data 7 (MSB) Blue Data 6 Blue Data 5 Blue Data 4 Blue Data 3 Blue Data 2 Blue Data 1 Blue Data 0 (LSB)	Blue-pixel Data Each blue pixel's brightness data consists of these 8 bits pixel data.
CLK+ CLK-	LVDS Clock Input	
DE	Display Enable	
VS	Vertical Sync Signal	
HS	Horizontal Sync Signal	

4.4.2 Timing Table

LCD Interface Timing (DE mode)

Parameter	Symbol	Value			Unit
		Min.	Typ.	Max.	
DCLK frequency @Frame rate=60hz	fclk	40.8	51.2	67.2	Mhz
Horizontal display area	thd	1024			DCLK
HSYNC period time	th	1114	1344	1400	DCLK
HSYNC blanking	thb+thfp	90	320	376	DCLK
Vertical display area	tvd	600			H
VSYNC period time	tv	610	635	800	H
VSYNC blanking	tvb+tvfp	10	35	200	H

CONFIDENTIAL

4-3 LED Driving Conditions

For Design reference only. These supply voltage and signals do not need to input by end user.

ITEM	SYMBOL	MIN	TYP	MAX	UNIT	NOTE
LED Driver Power Voltage	VLED	--	12	19	V	
LED Driver Power Current	I _{LED} (VLED=12V)	--	330	--	mA	Ta=25°C
PWM Dimming DC active level	V _{DIMH}	1.5	--	6	V	
	V _{DIML}	--	--	0.6	V	
PWM Dimming Freq.	F _{DIM}	0.2		20	kHz	
BLEN Pin High Voltage	V _{BLENH}	1.4		--	V	
BLEN Pin Low Voltage	V _{BLENL}	--		0.8	V	
LED voltage	V _{AK}	--	26.4	--	V	Note 1
LED current	I _F	--	120	--	mA	Note 1
LED life time	--	--	50	--	kHrs	Note 2

Note (1) The LED Supply Voltage is defined by the number of LED at Ta=25°C and I_F=120 mA.

Note (2) The "LED life time" is defined as the module brightness decrease to 50% original brightness at Ta=25°C and I_F=120mA. The LED lifetime could be decreased if operating I_F is larger than 120mA.

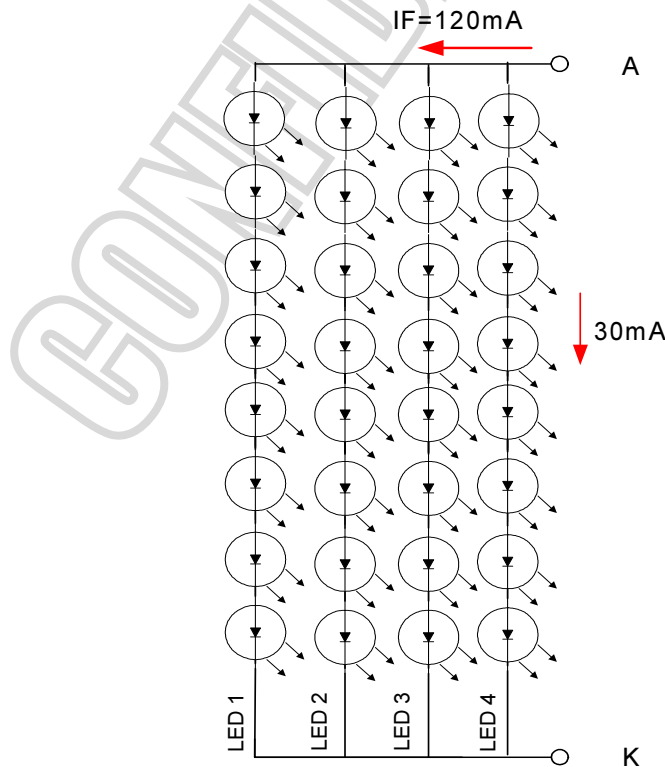

Note (3) When LCM is operated over 40°C ambient temperature, the I_F should be follow :

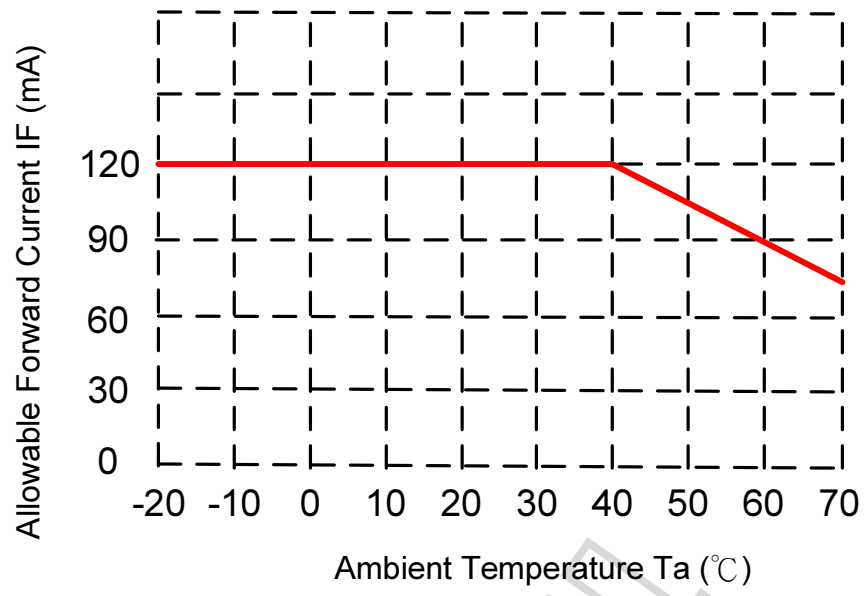

CONFIDENTIAL

5. INTERFACE

5.1 INTERFACE (HDMI Interface Board)

- **PJ2 Power Supply Power Jack:**

Inner terminal is positive. Outer terminal is GND

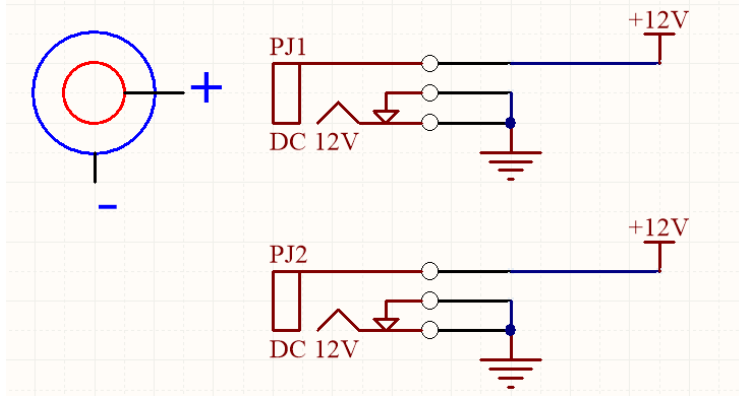

- **HDMI1: HDMI Type A Connector**

HDMI			
PIN	SIGNAL	PIN	SIGNAL
1	TMDS Data2+	11	TMDS Clock Shield (Ground)
2	TMDS Data2 Shield (Ground)	12	TMDS Clock-
3	TMDS Data2-	13	CEC (not used)
4	TMDS Data1+	14	Reserved (No Connection)
5	TMDS Data1 Shield (Ground)	15	SCL
6	TMDS Data1-	16	SDA
7	TMDS Data0+	17	DDC/CED (Ground)
8	TMDS Data0 Shield (Ground)	18	+5V input
9	TMDS Data0-	19	Hot Plug Detect
10	TMDS Clock+		

6. Optical Specifications

Item	Symbol	Condition	Values			Unit	Note
			Min.	Typ.	Max.		
Viewing angle (CR \geq 10)	Θ L	$\Phi = 180^\circ$ (9 o'clock)	70	80	--	degree	Note1
	Θ R	$\Phi = 0^\circ$ (3 o'clock)	70	80	--		
	Θ U	$\Phi = 90^\circ$ (12 o'clock)	60	70	--		
	Θ D	$\Phi = 270^\circ$ (6 o'clock)	70	80	--		
Response time	TON	Normal $\theta = \Phi = 0^\circ$	--	4	8	msec	Note3
	TOFF		--	12	24	msec	
Contrast ratio	CR		560	700	--	--	Note4
Color chromaticity	WX		0.26	0.31	0.36	--	Note5 Note6
	WY		0.31	0.36	0.41	--	
	RX		0.59	0.64	0.69		
	RY		0.27	0.32	0.37		
	GX		0.31	0.36	0.41		
	GY	0.53	0.58	0.63			
	BX	0.05	0.10	0.15			
Luminance (central point)	L	800	1000	--	cd/m ²	Note6	
	YU	70	75	--	%	Note6	

Test Conditions:

VDD = 3.3V, IF = 120 mA (Backlight current), the ambient temperature is 25°C.

The test systems refer to Note 2.

Note (1) Definition of viewing angle range

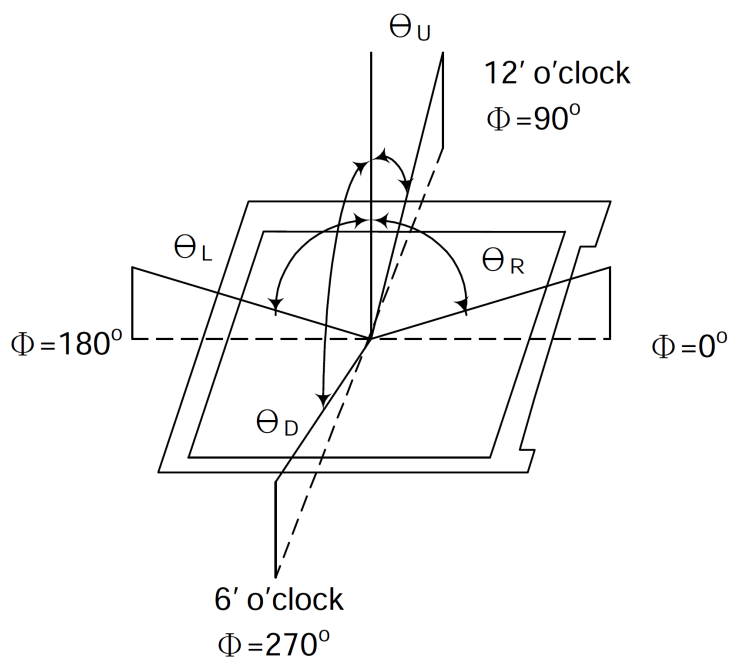

Note (2) Definition of optical measurement system

The optical characteristics should be measured in dark room. After 30 minutes operation, the optical properties are measured at the center point of the LCD screen. (Response time is measured by Photo detector TOPCON BM-7, other items are measured by BM-5A/Field of view: 1° / Height: 500mm.)

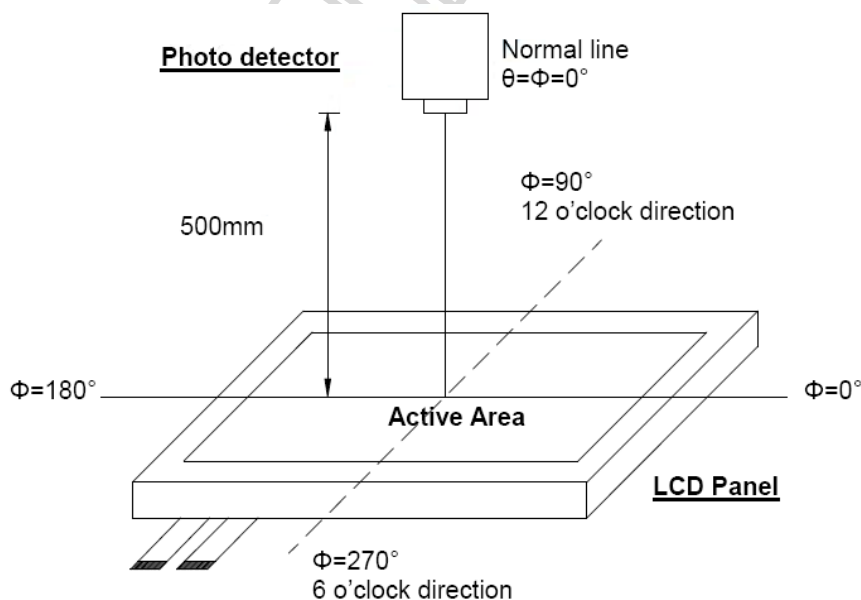

Note (3) Definition of Response time

The response time is defined as the LCD optical switching time interval between "White" state and "Black" state. Rise time (TON) is the time between photo detector

output intensity changed from 90% to 10%. And fall time (TOFF) is the time between photo detector output intensity changed from 10% to 90%.

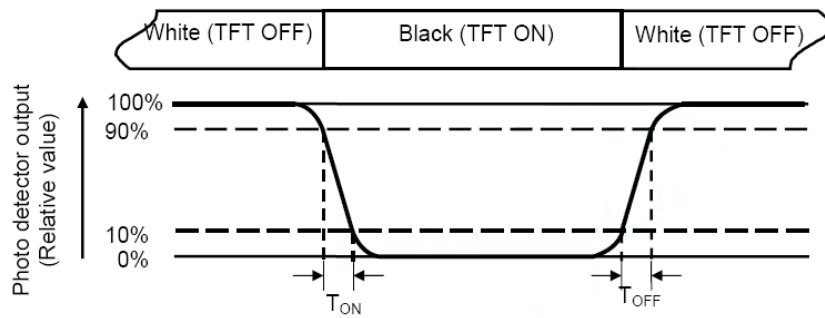

Note (4) Definition of contrast ratio

$$\text{Contrast ratio (CR)} = \frac{\text{Luminance measured when LCD on the "White" state}}{\text{Luminance measured when LCD on the "Black" state}}$$

Note (5) Definition of color chromaticity (CIE1931)

Color coordinated measured at center point of LCD.

All input terminals LCD panel must be ground when measuring the center area of the panel.

Note (6) Definition of Luminance Uniformity

Active area is divided into 9 measuring areas (Refer to bellow figure).

Every measuring point is placed at the center of each measuring area.

$$\text{Luminance Uniformity (Yu)} = \frac{B_{\min}}{B_{\max}}$$

L ----- Active area length W ----- Active area width

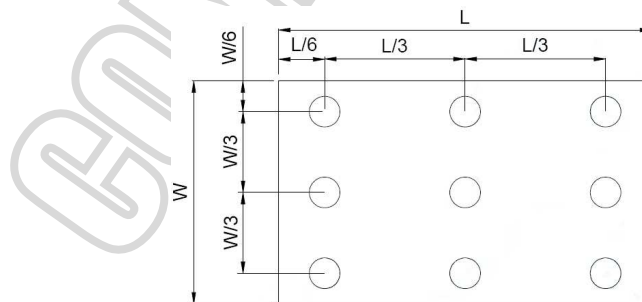

Bmax : The measured maximum luminance of all measurement position.

Bmin : The measured minimum luminance of all measurement position.

Note (7) Pixel format

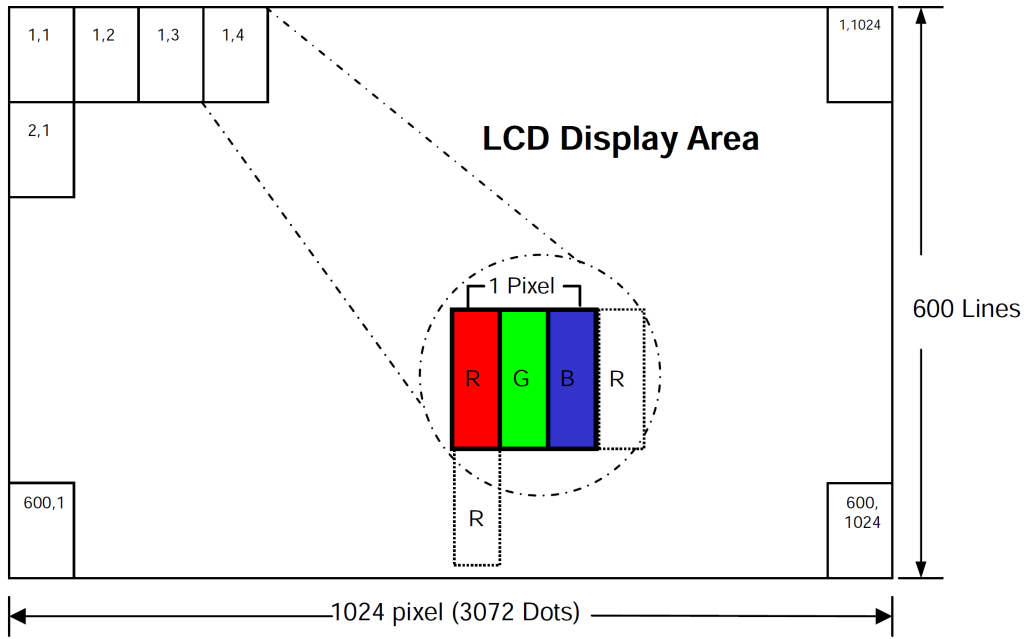

CONFIDENTIAL

8. ELIABILITY TEST CONDITIONS

Test Item	Test Conditions	Note
High Temperature Operation	70±3°C ,Dry t=240 hrs	
Low Temperature Operation	-20±3°C, Dry t=240 hrs	
High Temperature Storage	80±3°C , Dry t=240 hrs	1,2
Low Temperature Storage	-30±3°C ,Dry t=240 hrs	1,2
Thermal Shock Test	-20°C ~ 25°C ~ 70°C 30 m in. 5 min. 30 min. (1 cycle) Total 100 cycle(Dry)	1,2
Storage Humidity Test	60 °C, Humidity 90%, 240 hrs	1,2
Vibration Test (Packing)	Sweep frequency : 10 ~ 55 ~ 10 Hz/1min Amplitude : 0.75mm Test direction : X.Y.Z/3 axis Duration : 30min/each axis	2

Note 1 : Condensation of water is not permitted on the module.

Note 2 : The module should be inspected after 1 hour storage in normal conditions (15-35°C , 45-65%RH).

Definitions of life end point :

- Current drain should be smaller than the specific value.
- Function of the module should be maintained.
- Appearance and display quality should not have degraded noticeably.
- Contrast ratio should be greater than 50% of the initial value.

9. GENERAL PRECAUTION

9.1 Use Restriction

This product is not authorized for use in life supporting systems, aircraft navigation control systems, military systems and any other application where performance failure could be life-threatening or otherwise catastrophic.

9.2 Disassembling or Modification

Do not disassemble or modify the module. It may damage sensitive parts inside LCD module, and may cause scratches or dust on the display. AMPIRE does not warrant the module, if customers disassemble or modify the module.

9.3 Breakage of LCD Panel

- (1) If LCD panel is broken and liquid crystal spills out, do not ingest or inhale liquid crystal, and do not contact liquid crystal with skin.
- (2) If liquid crystal contacts mouth or eyes, rinse out with water immediately.
- (3) If liquid crystal contacts skin or cloths, wash it off immediately with alcohol and rinse thoroughly with water.
- (4) Handle carefully with chips of glass that may cause injury, when the glass is broken.

9.4 Electric Shock

- (1) Disconnect power supply before handling LCD module.
- (2) Do not pull or fold the LED cable.
- (3) Do not touch the parts inside LCD modules and the fluorescent LED's connector or cables in order to prevent electric shock.

9.5 Absolute Maximum Ratings and Power Protection Circuit

- (1) Do not exceed the absolute maximum rating values, such as the supply voltage variation, input voltage variation, variation in parts' parameters, environmental temperature, etc., otherwise LCD module may be damaged.
- (2) Please do not leave LCD module in the environment of high humidity and high temperature for a long time.
- (3) It's recommended to employ protection circuit for power supply.

9.6 Operation

- (1) Do not touch, push or rub the polarizer with anything harder than HB pencil lead.
- (2) Use fingerstalls of soft gloves in order to keep clean display quality, when persons handle the LCD module for incoming inspection or assembly.
- (3) When the surface is dusty, please wipe gently with absorbent cotton or other soft material.
- (4) Wipe off saliva or water drops as soon as possible. If saliva or water drops contact with polarizer for a long time, they may cause deformation or color fading.
- (5) When cleaning the adhesives, please use absorbent cotton wetted with a little petroleum benzene or other adequate solvent.

9.7 Mechanism

Please mount LCD module by using mounting holes arranged in four corners tightly.

9.8 Static Electricity

- (1) Protection film must remove very slowly from the surface of LCD module to prevent from electrostatic occurrence.
- (2) Because LCD modules use CMOS-IC on circuit board and TFT-LCD panel, it is very weak to electrostatic discharge. Please be careful with electrostatic discharge. Persons who handle the module should be grounded through adequate methods.

9.9 Strong Light Exposure

The module shall not be exposed under strong light such as direct sunlight. Otherwise, display characteristics may be changed.

9.10 Disposal

When disposing LCD module, obey the local environmental regulations.

9.11 Others

Do not keep the LCD at the same display pattern continually. The residual image will happen and it will damage the LCD. Please use screen saver.

10. OUTLINE DIMENSION

REV	REVISION RECORD	DATE	NAME
0	NEW RELEASE	06-12-17	EMILY

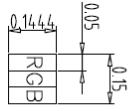

A Block

1	Data2+
2	Data2 Shield (Ground)
3	Data2-
4	Data1+
5	Data1 Shield (Ground)
6	Data1-
7	Data0+
8	Data0 Shield (Ground)
9	Data0-
10	Clock+
11	Clock Shield (Ground)
12	Clock-
13	CEC (not used)
14	Reserver (no connection)
15	Data1 Shield (Ground)
16	SCL
17	SDA
18	+5V Input
19	Hot Plug Detect

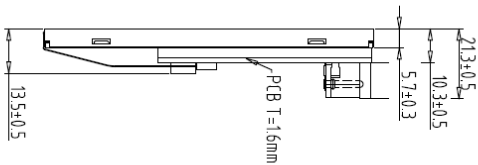
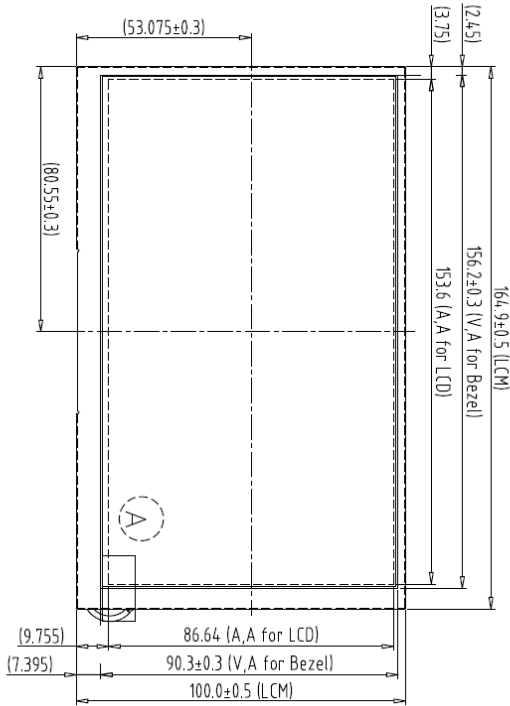

- Note:
1. Unless indicated, Tolerance "±0.3"
 2. UV Glue For OLB Protection.
 3. HDMI A TYPE: P0.5 19Pin/HDFP1L-1N51 or Equivalent
 4. CN1: P0.5 40PIN H2.0/089H40-000000-G2-R or Equivalent.
 5. DC Jack: DC-0005-20-20Z2S-Y or Equivalent.
 6. LCD 1024X3(R.G.B)x600=> 7.0" Digital TFT LCD

1	1024600A-A6 LCM	7		TOLERANCE GRADE(±)	A	B	DIM. MM	DRW. EMILY	DATE 06-12-17	TITLE 1024600A-H6	DRG. NO. *170653MA	SHEET 1 OF 1
2	New PCB (HDMI/4Layers)	8					IE NO.	CHK.	DATE			
3		9					PARTS NO. LCM	APPD.	DATE			
4		10					1024600A-H6					
5		11										
6		12										



REV.	REVISION RECORD	DATE NAME
0	NEW RELEASE	06-12-17/EMILY

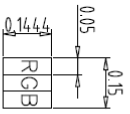

A Block

HDMI

1	Data2+
2	Data2 Shield (Ground)
3	Data2-
4	Data1+
5	Data1 Shield (Ground)
6	Data1-
7	Data0+
8	Data0 Shield (Ground)
9	Data0-
10	Clock+
11	Clock Shield (Ground)
12	Clock-
13	CEC (not used)
14	Reserver (no connection)
15	Data1 Shield (Ground)
16	SCL
17	SDA
18	+5V Input
19	Hot Plug Detect

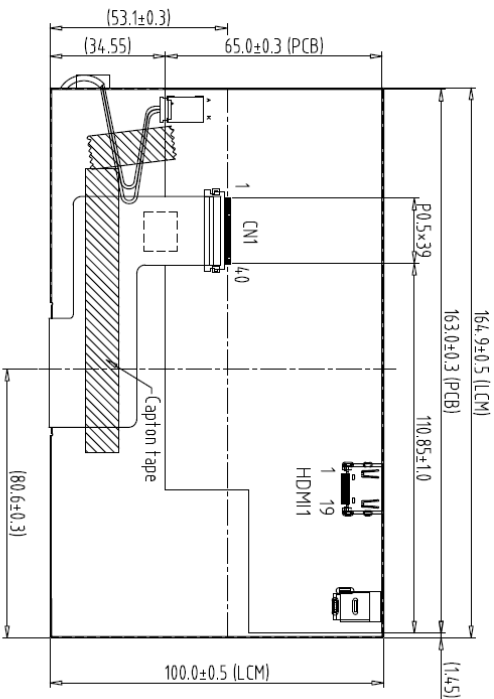

- Note:
1. Unless indicated, Tolerance "±0.3"
 2. UV Glue For OLB Protection.
 3. HDMI A TYPE:P0.5 19Pin/HDFP1L-1N51 or Equivalent
 4. CN1:P0.5 40PIN H2.0/089H40-000000-G2-R or Equivalent.
 5. DC Jack:DC-0005-20-20Z2S-Y or Equivalent.
 6. LCD 1024X3(R,G,B)x600=> 7.0" Digital TFT LCD

1	1024600A-A6 LCM	7		TOLERANCE GRAD(±)	A	B	DIM.	MM	DWG.	EMILY	DATE	TITLE	DWG. NO.	SHEET
2	New PCB (HDMI/4Layers)	8					IE NO.		CHK.		DATE	1024600A-H6	*170654MA	1 OF 1
3		9												
4		10												
5		11												
6		12					PARTS NO.LCM-1		APPD.		DATE			

晶采光電科技